

Aug.1.2021 Copyright 2021 HIROSE ELECTRIC CO., LTD. All Rights Reserved.
In case of consideration for using Automotive equipment / device which demand high reliability, kindly contact our sales window correspondents.

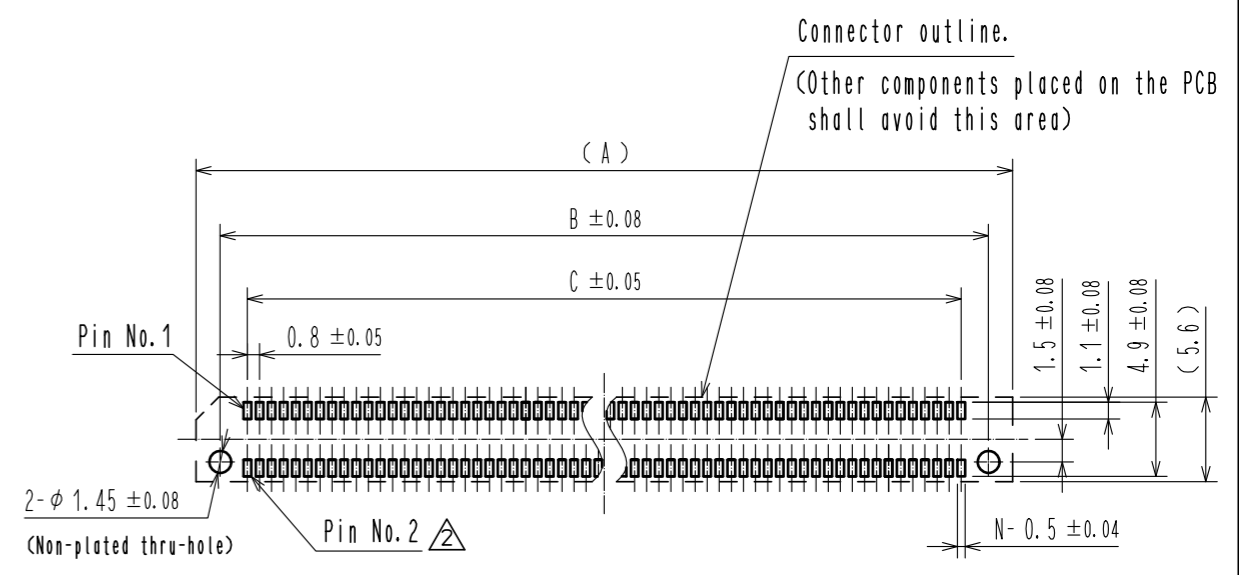
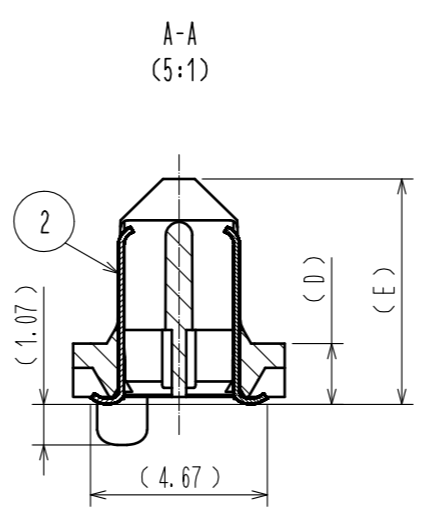
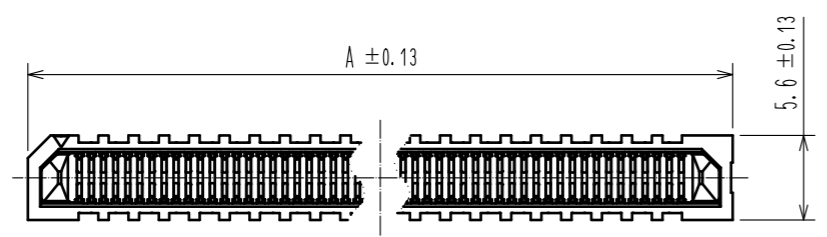

Fig.1 Recommended PCB Layout
(All dimensions are symmetric about the centerline)

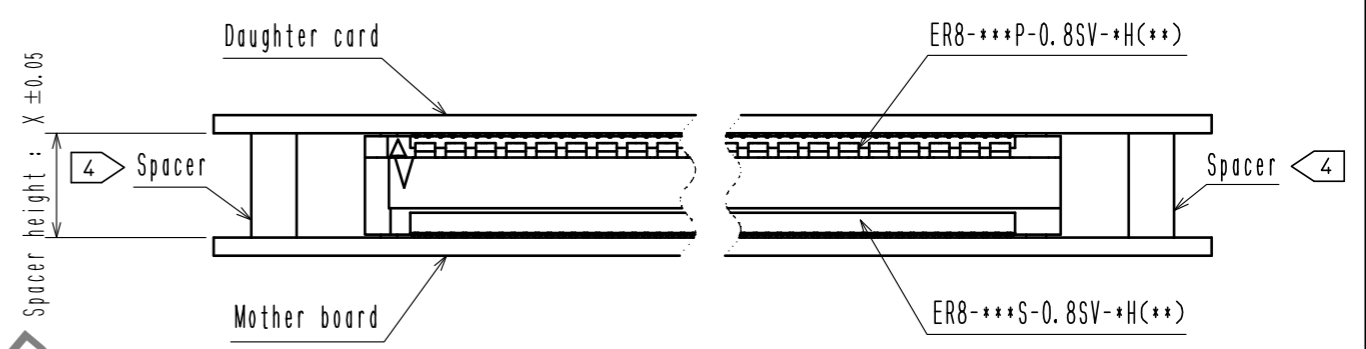
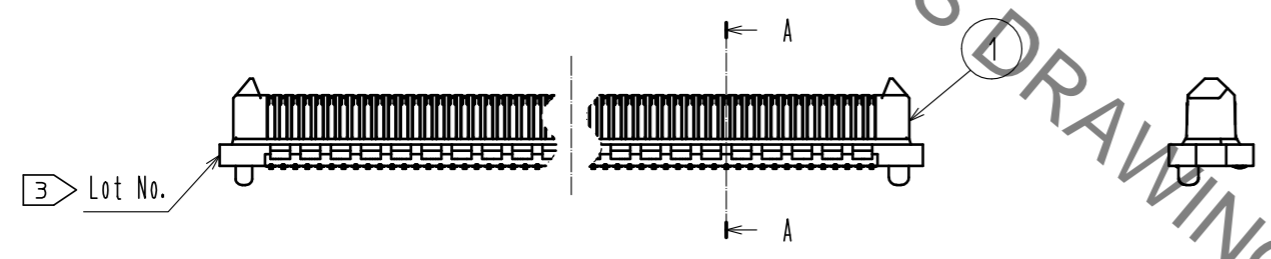
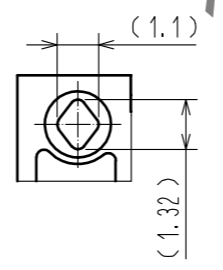
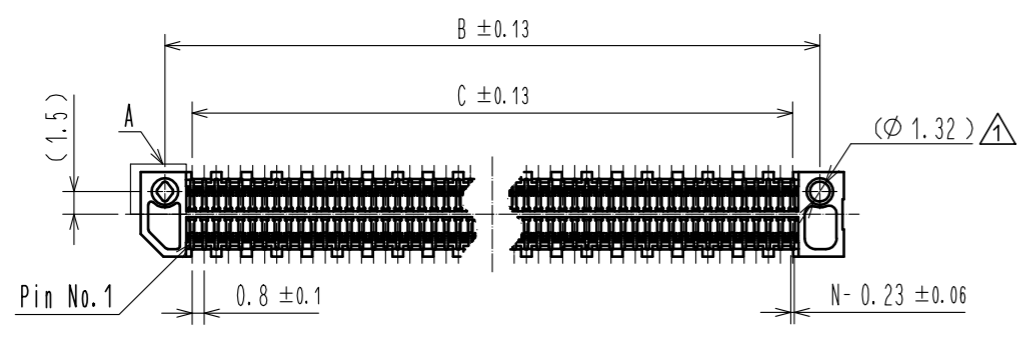

Fig.2 (Free)



- Note.
- Dimensions in parentheses () are for reference.
 - Packaging for this product applies embossed carrier tape packaging. See sheet 2/3 and 3/3 for details.
 - Lot No. shall be marked on the indicated position.
 - The indicated mother board and daughter card shall be gastened to the additional reinforcements to prevent the stress on ER8-***P-0.8SV-*H(**) and ER8-***S-0.8SV-*H(**).
 - Plating specification are below.

Part No.	Plating specification
ER8-***P-0.8SV-*H	CONTACT AREA : Ni2.54 μm + Au0.76 μm
	LEAD AREA : Ni1.25 μm + Sn3.81 μm
ER8-***P-0.8SV-*H(10)	CONTACT AREA : Ni1.25 μm + Au0.25 μm
	LEAD AREA : Ni1.25 μm + Sn2.54 μm

Plug	Receptacle	Spacer height (X)
ER8-***P-0.8SV-2H(**)	ER8-***S-0.8SV-5H(**)	7.15
	ER8-***S-0.8SV-7H(**)	9.15
ER8-***P-0.8SV-5H(**)	ER8-***S-0.8SV-5H(**)	10.15
	ER8-***S-0.8SV-7H(**)	12.15

Table1 Spacer height

NO.	MATERIAL	FINISH	REMARKS	NO.	MATERIAL	FINISH	REMARKS
3	POLYIMIDE		(TAPE FOR VACCUM PICK AND PLACE)	5	PE		(TOP COVER TAPE)
2	COPPER ALLOY	5		4	PS		(EMBOSSSED CARRIER TAPE)
1	LCP	BLACK	UL94V-0				

UNITS	SCALE	COUNT	DESCRIPTION OF REVISIONS	DESIGNED	CHECKED	DATE
mm	2 : 1	1	DIS-F-00006543	TF. SUGAWARA	NH. TAMAI	20200826

APPROVED	DATE	DRAWING NO.
MK. EZAKI	20160617	EDC-371040-00-00
CHECKED	DATE	PART NO.
MK. NAGATA	20160617	ER8-***P-0.8SV-*H(**)
DESIGNED	DATE	CODE NO.
TF. SUGAWARA	20160617	CL625
DRAWN	DATE	
TF. SUGAWARA	20160617	

Aug.1.2021 Copyright 2021 HIROSE ELECTRIC CO., LTD. All Rights Reserved.
 In case of consideration for using Automotive equipment / device which demand high reliability, kindly contact our sales window correspondents.

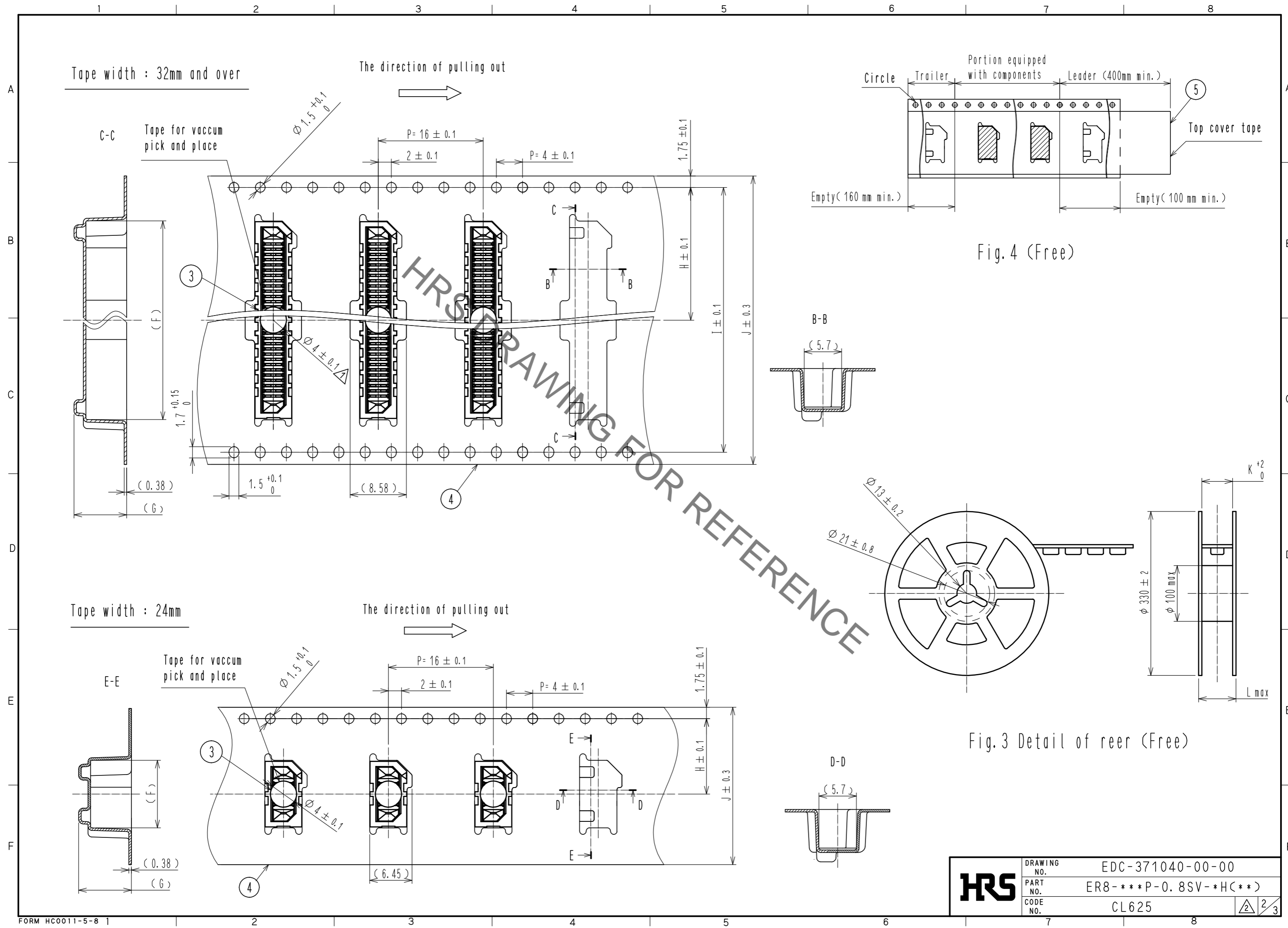

Aug.1.2021 Copyright 2021 HIROSE ELECTRIC CO., LTD. All Rights Reserved.
In case of consideration for using Automotive equipment / device which demand high reliability, kindly contact our sales window correspondents.

Part No.	Code No.	Contact positions (N)	Dimensions												Co-planarity	Qty/reel
			A	B	C	D	E	F	G	H	I	J	K	L		
ER8-10P-0.8SV-2H(**)	CL625-0008-8-**-	10	10	6.8	3.2	1.605	5.965	10.3	8.03	11.5	-	24	24.4	30.4	0.1 Max	450
ER8-20P-0.8SV-2H(**)	CL625-0011-0-**-	20	14	10.8	7.2	1.605	5.965	14.3	8.03	14.2	28.4	32	32.4	38.4	0.1 Max	475
ER8-30P-0.8SV-2H(**)	CL625-0012-0-**-	30	18	14.8	11.2	1.605	5.965	18.3	8.03	20.2	40.4	44	44.4	50.4	0.1 Max	475
ER8-40P-0.8SV-2H(**)	CL625-0013-0-**-	40	22	18.8	15.2	1.605	5.965	22.3	8.03	20.2	40.4	44	44.4	50.4	0.1 Max	350
ER8-50P-0.8SV-2H(**)	CL625-0009-0-**-	50	26	22.8	19.2	1.605	5.965	26.3	8.03	20.2	40.4	44	44.4	50.4	0.1 Max	350
ER8-60P-0.8SV-2H(**)	CL625-0017-0-**-	60	30	26.8	23.2	1.605	5.965	30.3	8.03	20.2	40.4	44	44.4	50.4	0.1 Max	350
ER8-70P-0.8SV-2H(**)	CL625-0021-0-**-	70	34	30.8	27.2	1.605	5.965	34.3	8.03	26.2	52.4	56	56.4	62.4	0.1 Max	350
ER8-80P-0.8SV-2H(**)	CL625-0022-0-**-	80	38	34.8	31.2	1.605	5.965	38.3	8.03	26.2	52.4	56	56.4	62.4	0.12 Max	350
ER8-100P-0.8SV-2H(**)	CL625-0023-0-**-	100	46	42.8	39.2	1.605	5.965	46.3	8.03	34.2	68.4	72	72.4	89	0.12 Max	350
ER8-120P-0.8SV-2H(**)	CL625-0003-4-**-	120	54	50.8	47.2	1.605	5.965	54.3	8.03	34.2	68.4	72	72.4	89	0.12 Max	375
ER8-10P-0.8SV-5H(**)	CL625-0024-0-**-	10	10	6.8	3.2	4.605	8.905	10.3	11	11.5	-	24	24.4	30.4	0.1 Max	325
ER8-20P-0.8SV-5H(**)	CL625-0025-0-**-	20	14	10.8	7.2	4.605	8.905	14.3	11	14.2	28.4	32	32.4	38.4	0.1 Max	325
ER8-30P-0.8SV-5H(**)	CL625-0026-0-**-	30	18	14.8	11.2	4.605	8.905	18.3	11	20.2	40.4	44	44.4	50.4	0.1 Max	325
ER8-40P-0.8SV-5H(**)	CL625-0020-0-**-	40	22	18.8	15.2	4.605	8.905	22.3	11	20.2	40.4	44	44.4	50.4	0.1 Max	250
ER8-50P-0.8SV-5H(**)	CL625-0027-0-**-	50	26	22.8	19.2	4.605	8.905	26.3	11	20.2	40.4	44	44.4	50.4	0.1 Max	250
ER8-60P-0.8SV-5H(**)	CL625-0019-0-**-	60	30	26.8	23.2	4.605	8.905	30.3	11	26.2	52.4	56	56.4	62.4	0.1 Max	250
ER8-70P-0.8SV-5H(**)	CL625-0028-0-**-	70	34	30.8	27.2	4.605	8.905	34.3	11	26.2	52.4	56	56.4	62.4	0.1 Max	250
ER8-80P-0.8SV-5H(**)	CL625-0029-0-**-	80	38	34.8	31.2	4.605	8.905	38.3	11	26.2	52.4	56	56.4	62.4	0.12 Max	250
ER8-100P-0.8SV-5H(**)	CL625-0030-0-**-	100	46	42.8	39.2	4.605	8.905	46.3	11	34.2	68.4	72	72.4	89	0.12 Max	250
ER8-120P-0.8SV-5H(**)	CL625-0031-0-**-	120	54	50.8	47.2	4.605	8.905	54.3	11	34.2	68.4	72	72.4	89	0.12 Max	250

Table2 Dimensions

HRS	DRAWING NO.	EDC-371040-00-00
	PART NO.	ER8-***P-0.8SV-*H(**)
	CODE NO.	CL625

3/3

X-ON Electronics

Largest Supplier of Electrical and Electronic Components

Click to view similar products for [Board to Board & Mezzanine Connectors](#) category:

Click to view products by [Hirose](#) manufacturer:

Other Similar products are found below :

[589158040000018](#) [MDF7C-18P-2.54DSA\(55\)](#) [FCN-230C068-11](#) [FCN-268F012-G/BD](#) [FCN-268F036-G/BD](#) [FCN-268M012-G/0D](#) [FCN-268M024-G/1D](#) [FCN-723J004/1](#) [MIS-048-01-F-D-DP-K](#) [832-10-034-10-001000](#) [FX4C-80S-1.27DSA](#) [FCN-214Q030-G/0](#) [FCN-234P048-G/0](#) [FCN-235D050-G/C](#) [210-93-314-41-105000](#) [2-22603-0](#) [MDF7-40DP-2.54DSA\(55\)](#) [AXG720047](#) [MIT-114-03-F-D-K](#) [55323-1519](#) [DF33-2P-3.3DSA\(24\)](#) [YFT-20-05-H-03-SB-K](#) [503308-3040](#) [026-6203-PDB](#) [027-6203-PDB](#) [069159702701000](#) [10123981-102LF](#) [101A10019X](#) [55650-0588-C](#) [68682-310LF](#) [68684-306](#) [75140-7012](#) [87471-650](#) [YTW-30-07-H-Q-410-140](#) [FCN-268F024-G0D](#) [10124054-515LF](#) [68685-603](#) [8-1616154-3](#) [MIS-019-01-F-D](#) [FCN-268M024-G/3D](#) [FCN-268M036-G/BD](#) [20021832-06016C1LF](#) [KX15-20KLDL-E1000E](#) [AXE810124](#) [FCN-214J100-G/0](#) [FCN-230C068-E/S](#) [AXE812124](#) [AXE816124](#) [AXE720127](#) [354184](#)