

10+Gbps 0.8mm pitch Board-to-Board Connectors

ER8 Series



Mechanical features

- 0.8mm Pitch
- Variations : Stacking / Vertical
- Stacking Height : 7 / 9 / 10 / 12mm
- Number of Contacts :
10 / 20 / 30 / 40 / 50 / 60 / 70 / 80 / 100 / 120pos
- Large mating guide for easy mating.
Alignment on plug provides easy insertion operation.
- Compatible with Samtec's Edge Rate®

Signal integrity features

● Insertion Loss-to-Crosstalk-Ratio (ICR)

The insertion loss-to-crosstalk ratio (ICR) with 5-aggressor differential FEXT meets the IEEE802.3ap specification for 10Gbps with plenty of margins.

● Differential Impedance

The differential impedance is 85Ω at 35 ps rise time. (20% to 80%)

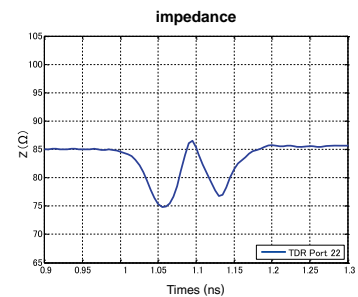
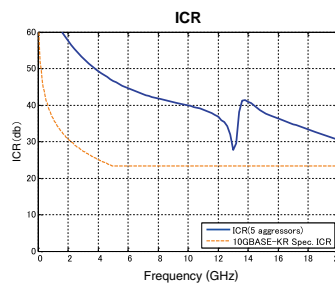

Variations

Stacking connection

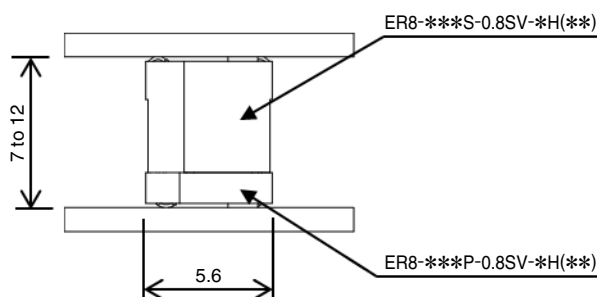

Vertical connection

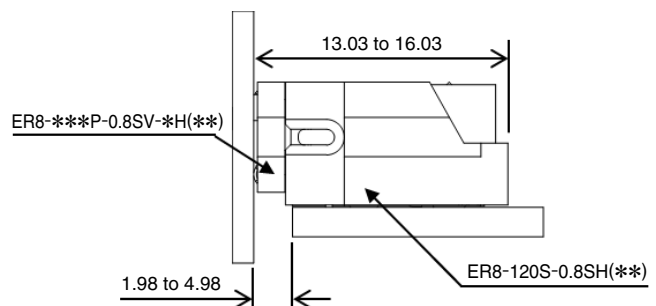

Product Specification

Rating	Current Rating	0.5A (Signal) (Note 3)	Operating Temperature Range	-55 to 85°C (Note 1)
	Voltage Rating	100V AC	Storage Temperature Range	-10 to 60°C (Note 2)
Item	Specification		Condition	
1. Contact Resistance	50mΩ max		100mA	
2. Insulation Resistance	1000MΩ min		100V DC	
3. Voltage Proof	No flashover or insulation breakdown		300V AC / 1min	
4. Durability (mating/unmating)	Contact resistance change : 15mΩ or less No flash over or breakdown No damage, crack or looseness of parts		100 cycles	
5. Vibration	No electrical discontinuity of 1μs or more No damage, crack or looseness of parts		Frequency : 20 to 500Hz, Power spectral density : 0.02G ² /Hz for 90 min in 3 directions	
6. Shock	No electrical discontinuity of 1μs or more No damage, crack or looseness of parts		980m/s ² , Duration of pulse 6ms, 18 times total, 3 each directions, 3 axis.	
7. Cyclic Temperature and Humidity	Contact resistance change : 15mΩ or less No damage, crack or looseness of parts No flashover or insulation breakdown Insulation resistance : 1000MΩ min		25°C, 90-95% RH : 120 min Dwell time ↑ ↓ 120 min Ramp time 65°C, 90-95% RH : 120 min Dwell time Under 12 cycles	

Note 1 : Includes temperature rise caused by current flow.

Note 2 : "Storage" means a long-term storage state for the unused product before assembly to PCB.

Note 3 : The rated current applies to per contact.

Note 4 : Information contained in this catalog represents general requirements for this Series. Contact us for the drawings and specifications for a specific part number shown.

Materials / Finish

●Straight Receptacle / Header

Part	Material	Finish	Remark
Insulator	LCP	Color : Black	UL94V-0
Contacts	Copper alloy	Contact area : Gold plated Lead area : Tin plated	—

●Right Angle Receptacle

Part	Material	Finish	Remark
Insulator	LCP	Color : Black	UL94V-0
Contacts	Copper alloy	Contact area : Gold plated Lead area : Tin plated	—
Retention peg	Copper alloy	Lead area : Tin plated	—
Retention pin	Copper alloy	Lead area : Tin plated	—

Product Number Structure

Refer to the chart below when determining the product specifications from the product number.

Please select from the product numbers listed in this catalog when placing orders.

●Straight Receptacle

ER8 - 120 S - 0.8 SV - *H ()**

① ② ③ ④ ⑤ ⑥ ⑦

●Straight Header

ER8 - 120 P - 0.8 SV - *H ()**

① ② ③ ④ ⑤ ⑥ ⑦

●Right Angle Receptacle

ER8 - 120 S - 0.8 SH ()**

① ② ③ ④ ⑤ ⑦

① Series Name :	ER8
② Number of contacts :	10 to 120
③ Connector Type	S : Receptacle P : Header
④ Contact Pitch :	0.8mm
⑤ Contact Type	SV : Board Straight Type SH : Board Right Angle Type
⑥ Stacking Height(mm) :	7 to 12 ※Height with ER8-****-0.8SV-*H(**)
⑦ Plating Specification	Blank : Contact Area : Gold(0.76μm)+Ni(2.54μm) (10) : Contact Area : Gold(0.25μm)+Ni(1.25μm)

Function Chart

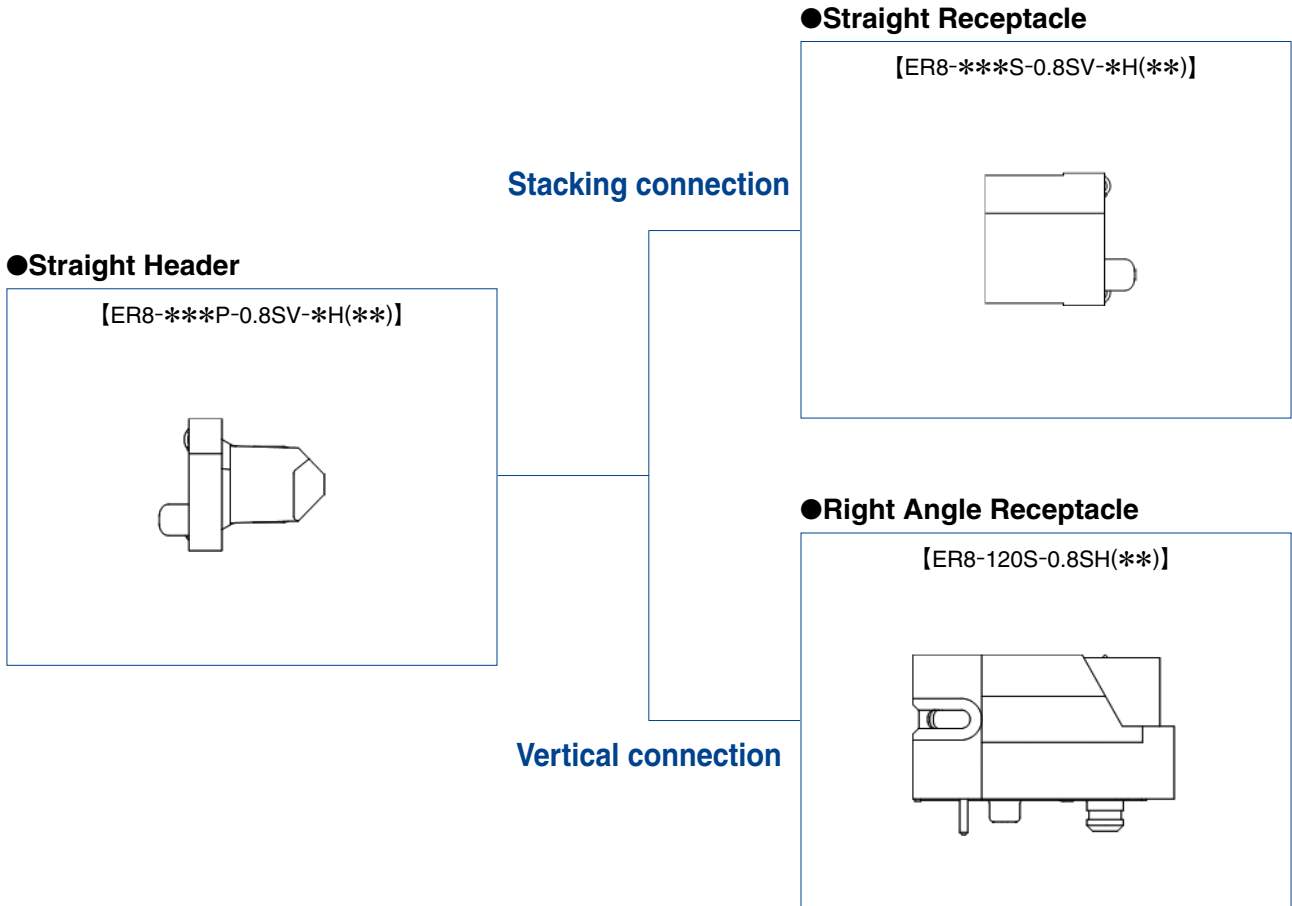

Stacking Height Variation

Contact Position / Stacking Height	10	20	30	40	50	60	70	80	100	120
7mm	✓	✓	✓	✓	✓	✓	✓	✓	✓	✓
9mm	✓	✓	✓	✓	✓	✓	✓	✓	✓	✓
10mm	✓	✓	✓	✓	✓	✓	✓	✓	✓	✓
12mm	✓	✓	✓	✓	✓	✓	✓	✓	✓	✓

Signal Integrity

●Pin assignment

To match 85Ω differential impedance and to reduce crosstalk, a staggered GSSG pin assignment is recommended for ER8.
(G = ground and S = signal)

※Analysis results only.

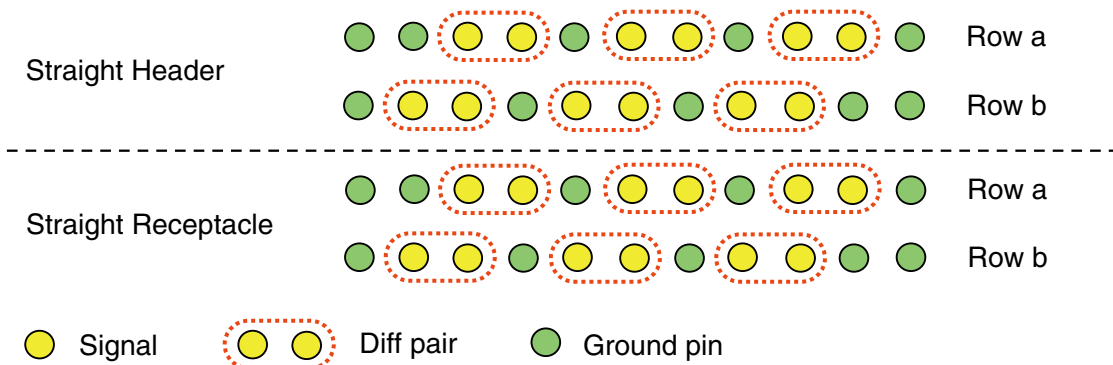

● Impedance

The differential impedance is 85Ω for at 35 ps rise time (20% to 80%)

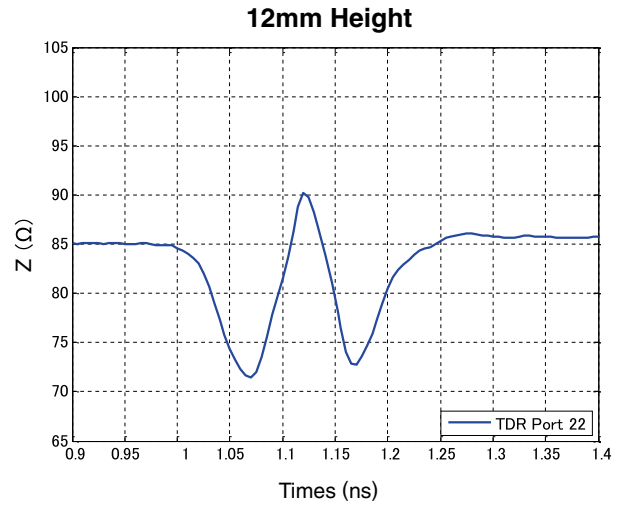
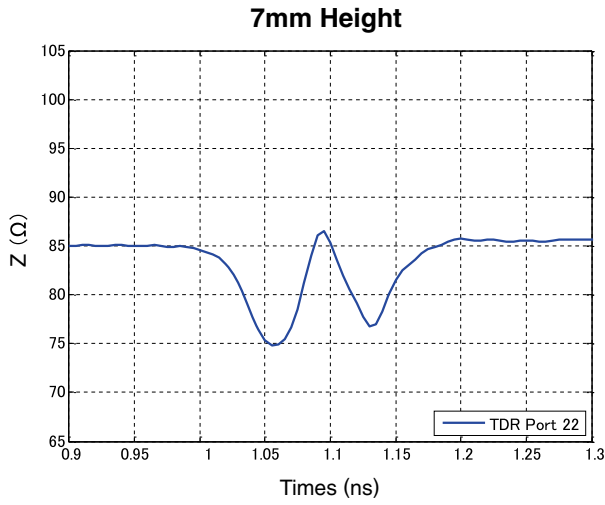

● Insertion Loss

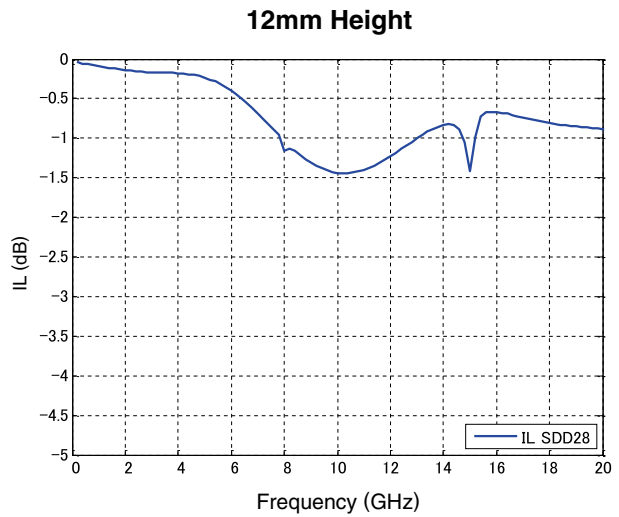
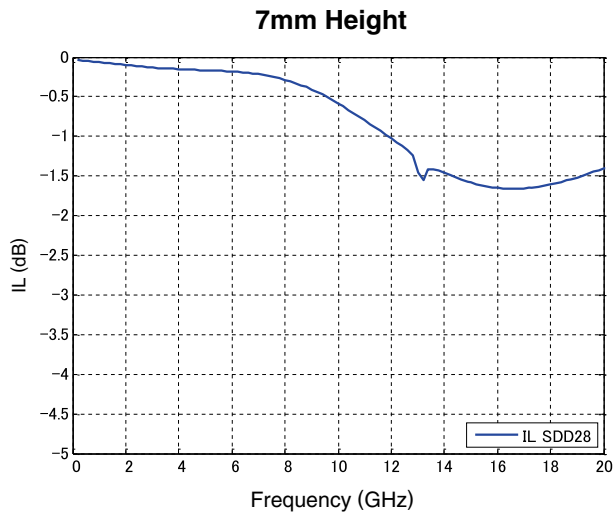

● Return loss

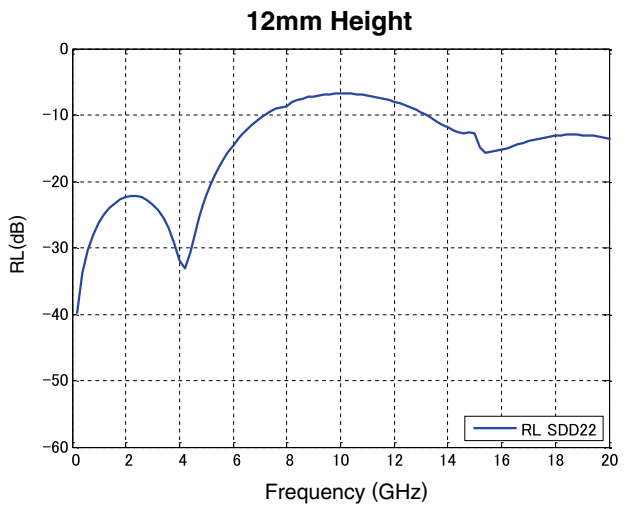
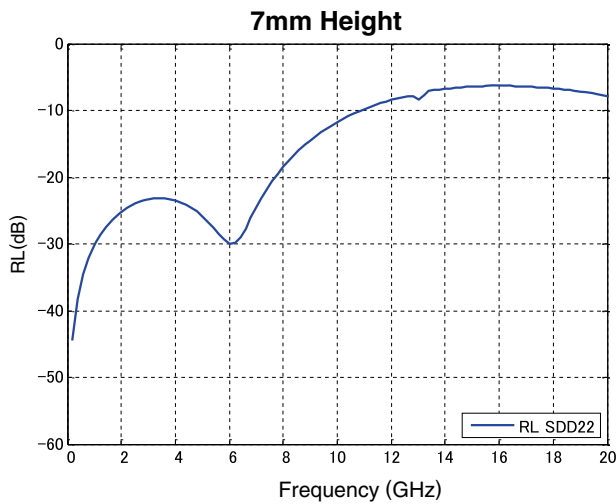

●Near-end crosstalk (NEXT)

The staggered GSSG pin assignments resulted in low differential NEXT.

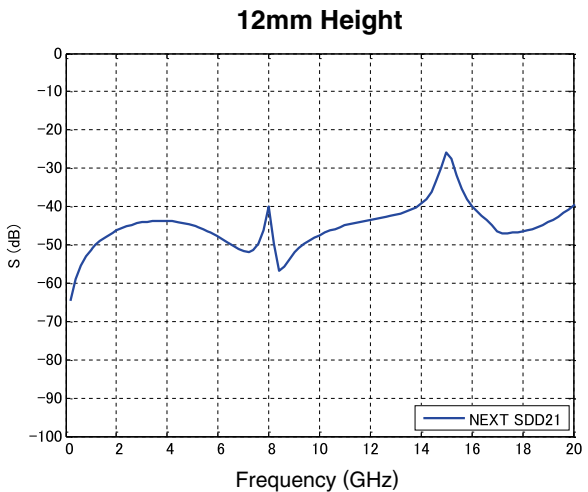
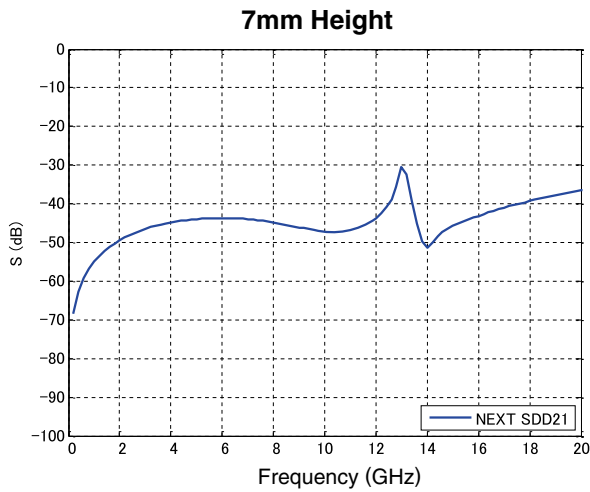

●Far-end crosstalk (FEXT)

The staggered GSSG pin assignments resulted in low differential FEXT.

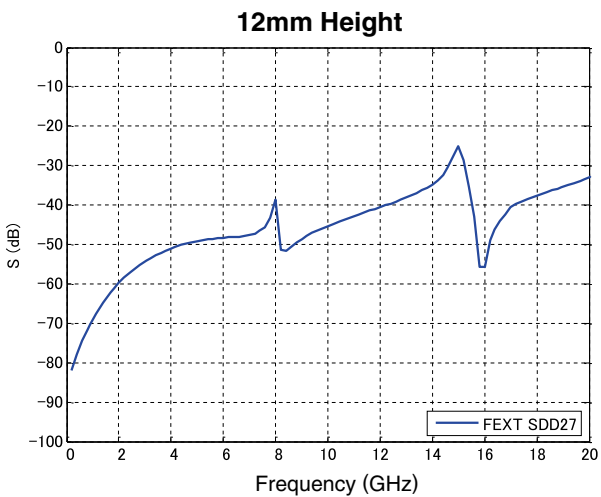
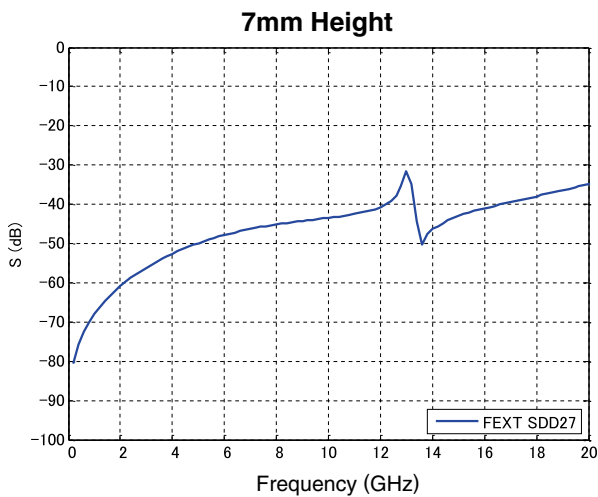

●Insertion-loss-to-crosstalk ratio (ICR)

The insertion-loss-to-crosstalk ratio (ICR) with 5-aggressor differential FEXT meets the extrapolated IEEE 802.3ap specification to 10Gbps with plenty of margins.

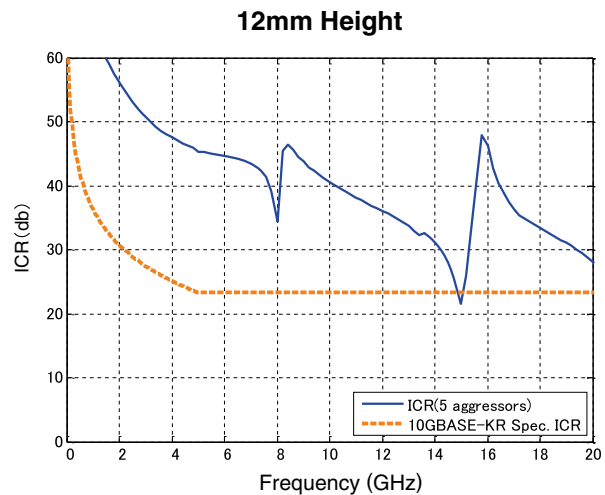
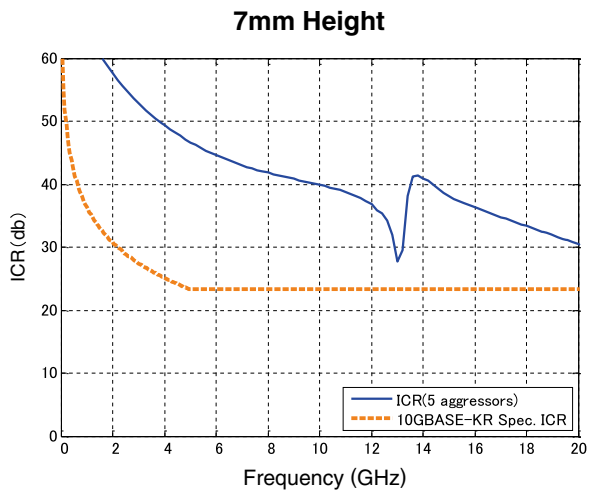

Straight Header

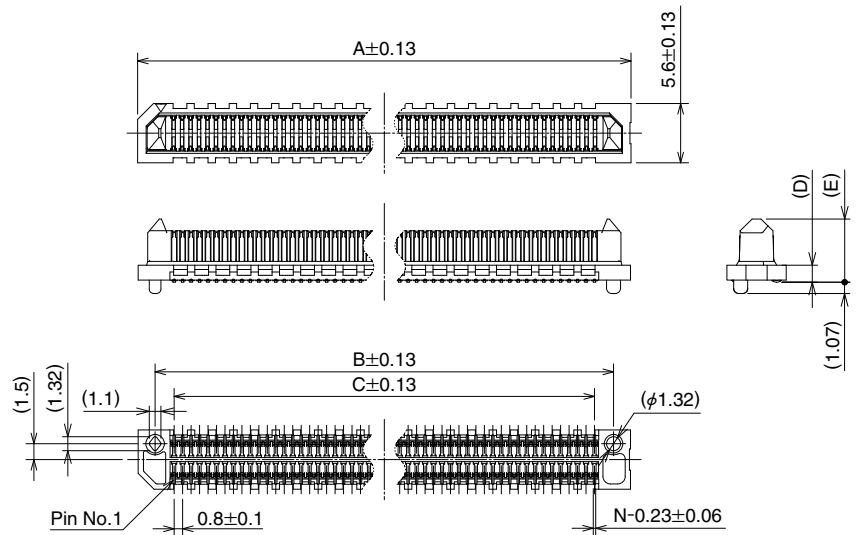

Unit : mm

Part No.	HRS No.	No. of Contacts (N)	A	B	C	D	E
ER8-10P-0.8SV-2H	625-0008-8 00	10	10	6.8	3.2	1.605	5.965
ER8-20P-0.8SV-2H	625-0011-0 00	20	14	10.8	7.2	1.605	5.965
ER8-30P-0.8SV-2H	625-0012-0 00	30	18	14.8	11.2	1.605	5.965
ER8-40P-0.8SV-2H	625-0013-0 00	40	22	18.8	15.2	1.605	5.965
ER8-50P-0.8SV-2H	625-0009-0 00	50	26	22.8	19.2	1.605	5.965
ER8-60P-0.8SV-2H	625-0017-0 00	60	30	26.8	23.2	1.605	5.965
ER8-70P-0.8SV-2H	625-0021-0 00	70	34	30.8	27.2	1.605	5.965
ER8-80P-0.8SV-2H	625-0022-0 00	80	38	34.8	31.2	1.605	5.965
ER8-100P-0.8SV-2H	625-0023-0 00	100	46	42.8	39.2	1.605	5.965
ER8-120P-0.8SV-2H	625-0003-4 00	120	54	50.8	47.2	1.605	5.965
ER8-10P-0.8SV-5H	625-0024-0 00	10	10	6.8	3.2	4.605	8.905
ER8-20P-0.8SV-5H	625-0025-0 00	20	14	10.8	7.2	4.605	8.905
ER8-30P-0.8SV-5H	625-0026-0 00	30	18	14.8	11.2	4.605	8.905
ER8-40P-0.8SV-5H	625-0020-0 00	40	22	18.8	15.2	4.605	8.905
ER8-50P-0.8SV-5H	625-0027-0 00	50	26	22.8	19.2	4.605	8.905
ER8-60P-0.8SV-5H	625-0019-0 00	60	30	26.8	23.2	4.605	8.905
ER8-70P-0.8SV-5H	625-0028-0 00	70	34	30.8	27.2	4.605	8.905
ER8-80P-0.8SV-5H	625-0029-0 00	80	38	34.8	31.2	4.605	8.905
ER8-100P-0.8SV-5H	625-0030-0 00	100	46	42.8	39.2	4.605	8.905
ER8-120P-0.8SV-5H	625-0031-0 00	120	54	50.8	47.2	4.605	8.905

Straight Receptacle

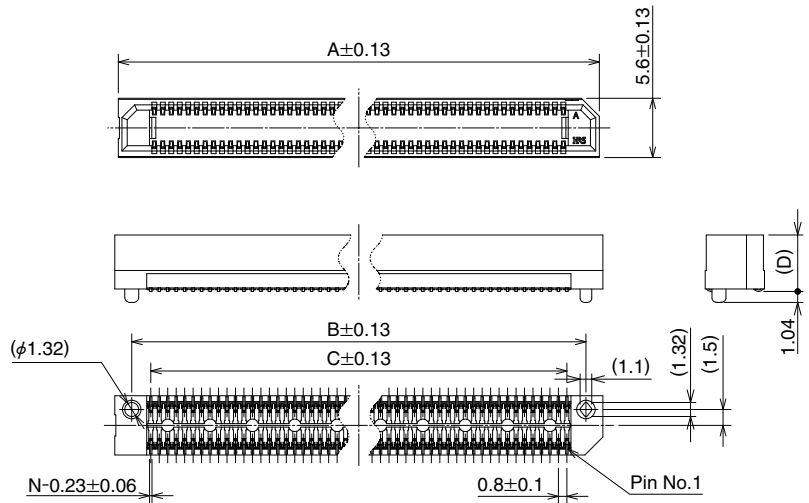

Unit : mm

Part No.	HRS No.	No. of Contacts (N)	A	B	C	D
ER8-10S-0.8SV-5H	625-0007-5 00	10	10	6.8	3.2	5.335
ER8-20S-0.8SV-5H	625-0014-0 00	20	14	10.8	7.2	5.335
ER8-30S-0.8SV-5H	625-0015-0 00	30	18	14.8	11.2	5.335
ER8-40S-0.8SV-5H	625-0016-0 00	40	22	18.8	15.2	5.335
ER8-50S-0.8SV-5H	625-0010-0 00	50	26	22.8	19.2	5.335
ER8-60S-0.8SV-5H	625-0018-0 00	60	30	26.8	23.2	5.335
ER8-70S-0.8SV-5H	625-0032-0 00	70	34	30.8	27.2	5.335
ER8-80S-0.8SV-5H	625-0033-0 00	80	38	34.8	31.2	5.335
ER8-100S-0.8SV-5H	625-0034-0 00	100	46	42.8	39.2	5.335
ER8-120S-0.8SV-5H	625-0035-0 00	120	54	50.8	47.2	5.335
ER8-10S-0.8SV-7H	625-0036-0 00	10	10	6.8	3.2	7.25
ER8-20S-0.8SV-7H	625-0037-0 00	20	14	10.8	7.2	7.25
ER8-30S-0.8SV-7H	625-0038-0 00	30	18	14.8	11.2	7.25
ER8-40S-0.8SV-7H	625-0039-0 00	40	22	18.8	15.2	7.25
ER8-50S-0.8SV-7H	625-0040-0 00	50	26	22.8	19.2	7.25
ER8-60S-0.8SV-7H	625-0041-0 00	60	30	26.8	23.2	7.25
ER8-70S-0.8SV-7H	625-0042-0 00	70	34	30.8	27.2	7.25
ER8-80S-0.8SV-7H	625-0043-0 00	80	38	34.8	31.2	7.25
ER8-100S-0.8SV-7H	625-0044-0 00	100	46	42.8	39.2	7.25
ER8-120S-0.8SV-7H	625-0045-0 00	120	54	50.8	47.2	7.25

Right Angle Receptacle

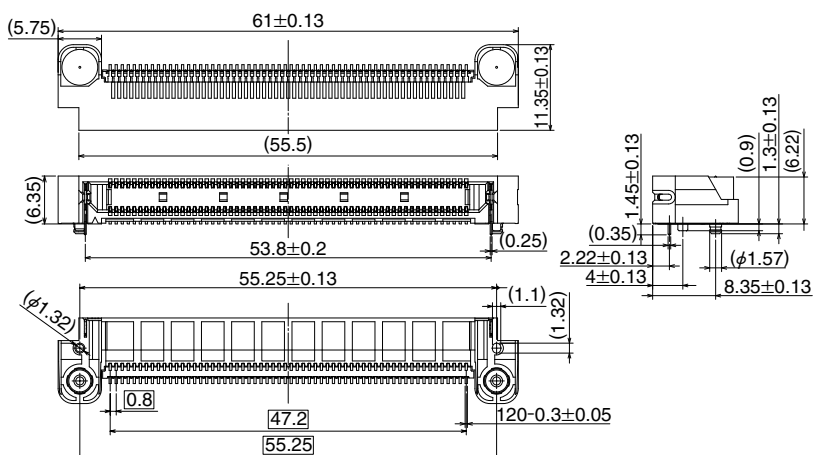
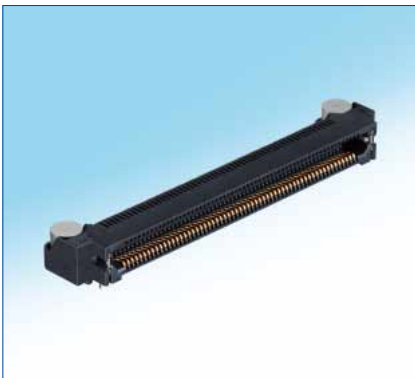

Part No.	HRS No.	No. of Contacts (N)
ER8-120S-0.8SH	625-1001-4 00	120

Recommended PCB Mouting Pattern (Stencil thickness : t=0.15mm)

●Straight Header

Unit : mm

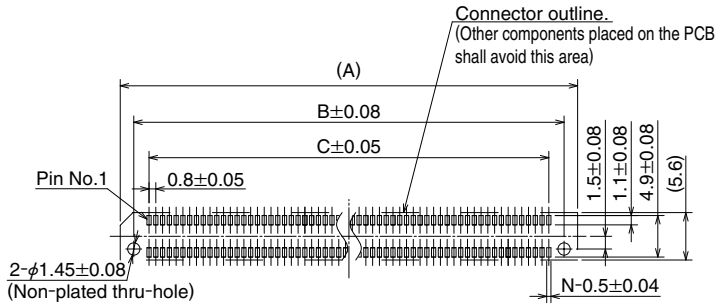

No. of Contacts (N)	A	B	C
10	10	6.8	3.2
20	14	10.8	7.2
30	18	14.8	11.2
40	22	18.8	15.2
50	26	22.8	19.2
60	30	26.8	23.2
70	34	30.8	27.2
80	38	34.8	31.2
100	46	42.8	39.2
120	54	50.8	47.2

●Straight Receptacle

Unit : mm

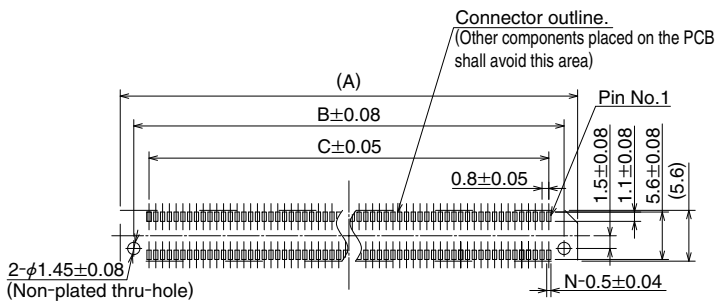

No. of Contacts (N)	A	B	C
10	10	6.8	3.2
20	14	10.8	7.2
30	18	14.8	11.2
40	22	18.8	15.2
50	26	22.8	19.2
60	30	26.8	23.2
70	34	30.8	27.2
80	38	34.8	31.2
100	46	42.8	39.2
120	54	50.8	47.2

●Right Angle Receptacle

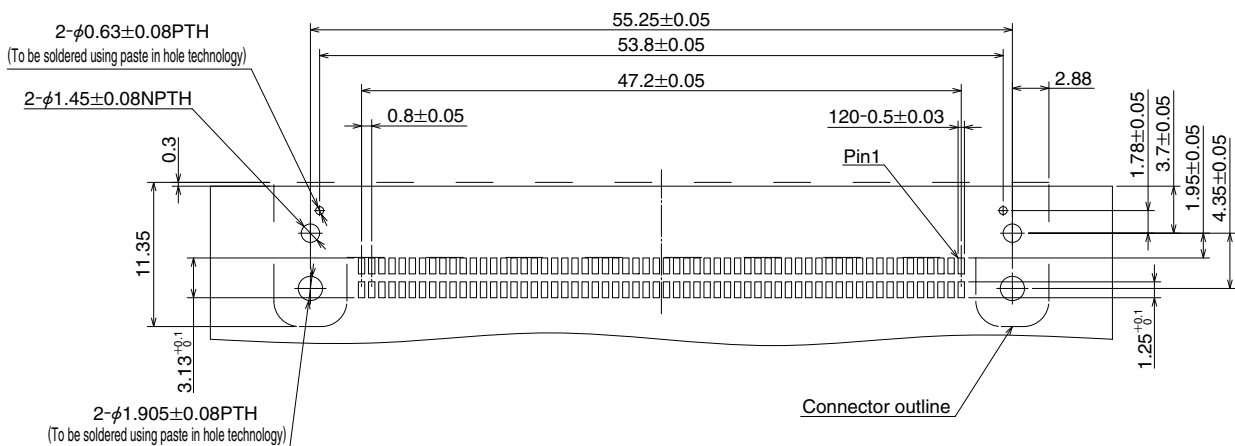

◆ER8 vs Edge Rate (Samtec) Reference List

●Straight Header

Part No.	HRS No.	Samtec Product Name
ER8-10P-0.8SV-2H	625-0008-8 00	ERM8-005-02.0-S-DV-K-TR
ER8-20P-0.8SV-2H	625-0011-0 00	ERM8-010-02.0-S-DV-K-TR
ER8-30P-0.8SV-2H	625-0012-0 00	—
ER8-40P-0.8SV-2H	625-0013-0 00	ERM8-020-02.0-S-DV-K-TR
ER8-50P-0.8SV-2H	625-0009-0 00	ERM8-025-02.0-S-DV-K-TR
ER8-60P-0.8SV-2H	625-0017-0 00	ERM8-030-02.0-S-DV-K-TR
ER8-70P-0.8SV-2H	625-0021-0 00	ERM8-035-02.0-S-DV-K-TR
ER8-80P-0.8SV-2H	625-0022-0 00	ERM8-040-02.0-S-DV-K-TR
ER8-100P-0.8SV-2H	625-0023-0 00	ERM8-050-02.0-S-DV-K-TR
ER8-120P-0.8SV-2H	625-0003-4 00	ERM8-060-02.0-S-DV-K-TR
ER8-10P-0.8SV-5H	625-0024-0 00	ERM8-005-05.0-S-DV-K-TR
ER8-20P-0.8SV-5H	625-0025-0 00	ERM8-010-05.0-S-DV-K-TR
ER8-30P-0.8SV-5H	625-0026-0 00	—
ER8-40P-0.8SV-5H	625-0020-0 00	ERM8-020-05.0-S-DV-K-TR
ER8-50P-0.8SV-5H	625-0027-0 00	ERM8-025-05.0-S-DV-K-TR
ER8-60P-0.8SV-5H	625-0019-0 00	ERM8-030-05.0-S-DV-K-TR
ER8-70P-0.8SV-5H	625-0028-0 00	ERM8-035-05.0-S-DV-K-TR
ER8-80P-0.8SV-5H	625-0029-0 00	ERM8-040-05.0-S-DV-K-TR
ER8-100P-0.8SV-5H	625-0030-0 00	ERM8-050-05.0-S-DV-K-TR
ER8-120P-0.8SV-5H	625-0031-0 00	ERM8-060-05.0-S-DV-K-TR

●Straight Receptacle

Part No.	HRS No.	Samtec Product Name
ER8-10S-0.8SV-5H	625-0007-5 00	ERF8-005-05.0-S-DV-K-TR
ER8-20S-0.8SV-5H	625-0014-0 00	ERF8-010-05.0-S-DV-K-TR
ER8-30S-0.8SV-5H	625-0015-0 00	—
ER8-40S-0.8SV-5H	625-0016-0 00	ERF8-020-05.0-S-DV-K-TR
ER8-50S-0.8SV-5H	625-0010-0 00	ERF8-025-05.0-S-DV-K-TR
ER8-60S-0.8SV-5H	625-0018-0 00	ERF8-030-05.0-S-DV-K-TR
ER8-70S-0.8SV-5H	625-0032-0 00	ERF8-035-05.0-S-DV-K-TR
ER8-80S-0.8SV-5H	625-0033-0 00	ERF8-040-05.0-S-DV-K-TR
ER8-100S-0.8SV-5H	625-0034-0 00	ERF8-050-05.0-S-DV-K-TR
ER8-120S-0.8SV-5H	625-0035-0 00	ERF8-060-05.0-S-DV-K-TR
ER8-10S-0.8SV-7H	625-0036-0 00	ERF8-005-07.0-S-DV-K-TR
ER8-20S-0.8SV-7H	625-0037-0 00	ERF8-010-07.0-S-DV-K-TR
ER8-30S-0.8SV-7H	625-0038-0 00	—
ER8-40S-0.8SV-7H	625-0039-0 00	ERF8-020-07.0-S-DV-K-TR
ER8-50S-0.8SV-7H	625-0040-0 00	ERF8-025-07.0-S-DV-K-TR
ER8-60S-0.8SV-7H	625-0041-0 00	ERF8-030-07.0-S-DV-K-TR
ER8-70S-0.8SV-7H	625-0042-0 00	ERF8-035-07.0-S-DV-K-TR
ER8-80S-0.8SV-7H	625-0043-0 00	ERF8-040-07.0-S-DV-K-TR
ER8-100S-0.8SV-7H	625-0044-0 00	ERF8-050-07.0-S-DV-K-TR
ER8-120S-0.8SV-7H	625-0045-0 00	ERF8-060-07.0-S-DV-K-TR

●Right Angle Receptacle

Part No.	HRS No.	Samtec Product Name
ER8-120S-0.8SH	625-1001-4 00	ERF8-060-01-L-D-RA-TR

◆ Processing recommendations

● Mating Alignment Requirements (Note 5)

Maximum guidance in applications where at least one half of the interface is free to flat.

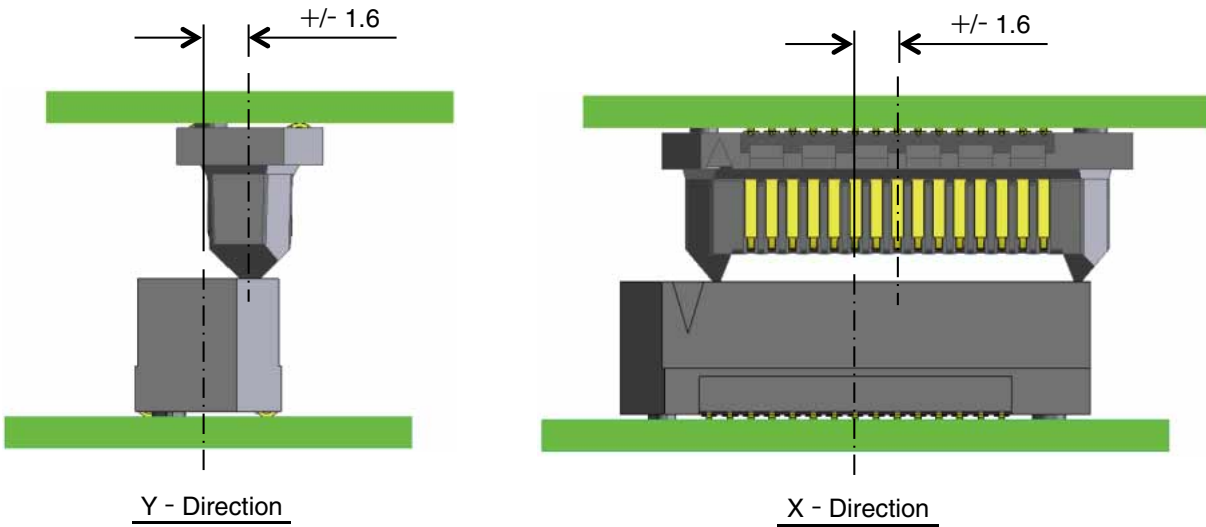

● Mating Angle Requirements (Note 5)

The connector can be zippered to 5 degrees in the longitudinal direction only.

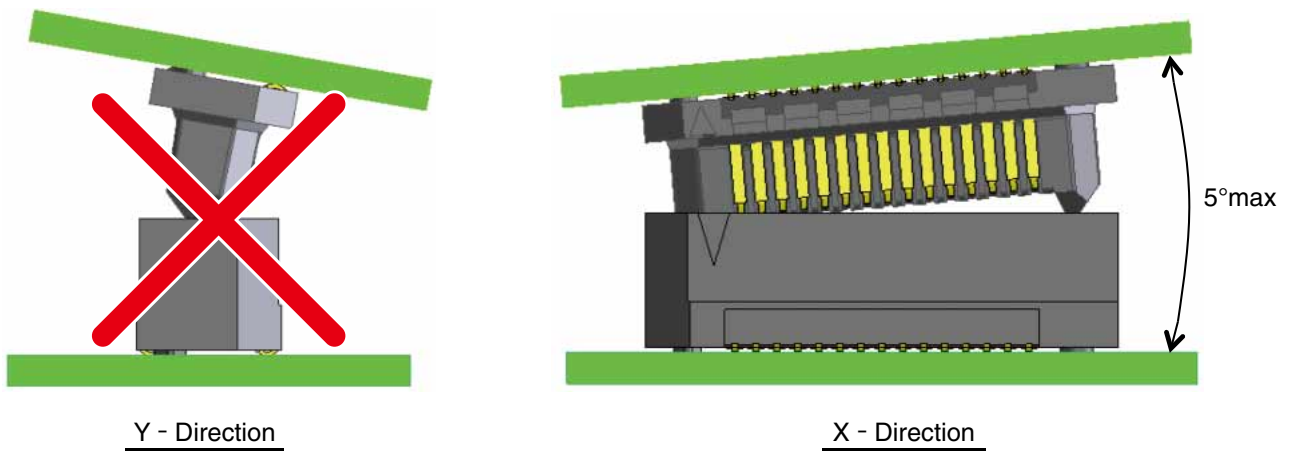

Not recommended lateral zipper mating and unmating in Y - Direction.

Note 5 : These values do not include the influence of misalignment in other axis nor rotation / inclination in the same time, except for the misalignment in the single axis shown in each figure.

◆ Recommended Spacer Height

Spacers required to support PWB's and protect the SMT solder joints.

Unit : mm

Stacking Height	Recommended Spacer Height
7	7.15 +/- 0.05
9	9.15 +/- 0.05
10	10.15 +/- 0.05
12	12.15 +/- 0.05

◆ Mounting Temperature Profile (Reference)

● Pb-Free Assembly

Preheat / Soak (150°C-200°C)	Max Ramp Up Rate	Reflow Time (above 217°C)	Peak Temp	Time within 5°C of 260°C	Max Ramp Down Rate	Time 25°C to Peak Temp
60-120 sec.	3°C /s max.	40-150 sec.	260°C	30 sec max.	6°C/s max.	8 min max.

◆ Recommended Temperature Profile

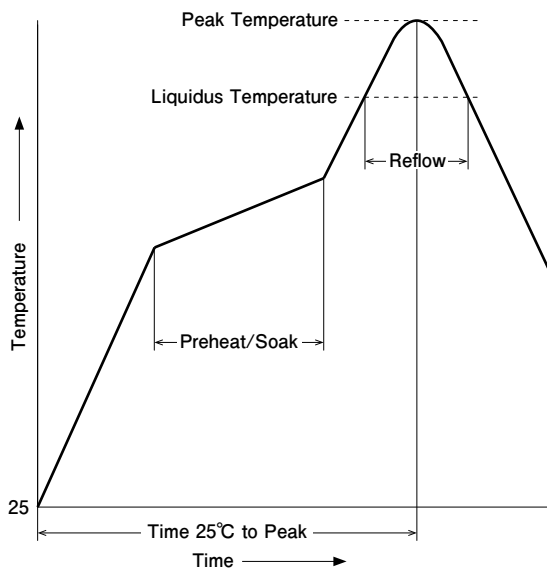

The temperature profile is based on the above conditions.

In individual applications the actual temperature may vary, depending on solder paste type, Volume/thickness and board size/thickness.

Consult your solder paste and equipment manufacturer for specific recommendations.

◆ Cleaning recommendations

● Organic solvent cleaning

Solvent Type	Room temperature cleaning	Heated cleaning
IPA (Isopropyl alcohol)	Yes	Yes
HCFC (Hydrochlorofluorocarbon)	Yes	Yes

● Water based cleaning

When using water based cleaning agents (e.g., terpene, alkali saponifiers), select the cleaning agent based on the documentation issued by the various manufacturers of cleaning agents which describes its effects on metals, platings and plastics. Remove any moisture after cleaning. Residual flux or cleaning agents in the contact areas may affect electrical performance.

USA:

HIROSE ELECTRIC (U.S.A.), INC. HEADQUARTERS CHICAGO OFFICE
2300 Warrenville Road, Suite 150,
Downers Grove, IL 60515
Phone : +1-630-282-6700
<http://www.hirose.com/us/>

USA:

HIROSE ELECTRIC (U.S.A.), INC. BOSTON OFFICE
300 Brickstone Square Suite 201,
Andover, MA 01810
Phone : +1-978-662-5255

GERMANY:

HIROSE ELECTRIC EUROPE B.V. NUREMBERG OFFICE
Neumeyerstrasse 22-26, 90411 Nurnberg
Phone : +49-911 32 68 89 63
Fax : +49-911 32 68 89 69
<http://www.hirose.com/eu/>

UNITED KINGDOM:

HIROSE ELECTRIC EUROPE BV (UK BRANCH)
4 Newton Court, Kelvin Drive, Knowlhill,
Milton Keynes, MK5 8NH
Phone : +44-1908 202050
Fax : +44-1908 202058
<http://www.hirose.com/eu/>

CHINA:

HIROSE ELECTRIC TECHNOLOGIES (SHENZHEN) CO., LTD.
Room 09-13, 19/F, Office Tower Shun Hing Square, Di Wang Commercial Centre,
5002 Shen Nan Dong Road, Shenzhen City, Guangdong Province, 518008
Phone : +86-755-8207-0851
Fax : +86-755-8207-0873
<http://www.hirose.com/cn/>

KOREA:

HIROSE KOREA CO.,LTD.
143, Gongdan 1-daero, Siheung-si,
Gyeonggi-do, 15084, Korea
Phone : +82-31-496-7000
Fax : +82-31-496-7100
<http://www.hirose.co.kr/>

INDIA:

HIROSE ELECTRIC SINGAPORE PTE. LTD. BANGALORE LIAISON OFFICE
Unit No-403, 4th Floor, No-84, Barton Centre, Mahatma
Gandhi (MG) Road, Bangalore 560 001, Karnataka, India
Phone : +91-80-4120 1907
Fax : +91-80-4120 9908
<http://www.hirose.com/sg/>

USA:

HIROSE ELECTRIC (U.S.A.), INC. SAN JOSE OFFICE
2841 Junction Ave, Suite 200
San Jose, CA. 95134
Phone : +1-408-253-9640
Fax : +1-408-253-9641
<http://www.hirose.com/us/>

THE NETHERLANDS:

HIROSE ELECTRIC EUROPE B.V.
Hogehillweg #8 1101 CC Amsterdam Z-0
Phone : +31-20-6557460
Fax : +31-20-6557469
<http://www.hirose.com/eu/>

GERMANY:

HIROSE ELECTRIC EUROPE B.V. HANOVER OFFICE
Bayernstr. 3, Haus C 30855 Langenhagen, Germany
Phone : +49-511 97 82 61 30
Fax : +49-511 97 82 61 35
<http://www.hirose.com/eu/>

CHINA:

HIROSE ELECTRIC (SHANGHAI) CO., LTD.
18, Enterprise Center Tower 2, 209# Gong He
Road, Jing'an District, Shanghai, CHINA 200070
Phone : +86-21-6391-3355
Fax : +86-21-6391-3335
<http://www.hirose.com/cn/>

HONG KONG:

HIROSE ELECTRIC HONGKONG TRADING CO., LTD.
Room 1001, West Wing, Tsim Sha Tsui Centre, 66
Mody Road, Tsim Sha Tsui East, Kowloon, Hong Kong
Phone : +852-2803-5338
Fax : +852-2591-6560
<http://www.hirose.com/hk/>

SINGAPORE:

HIROSE ELECTRIC SINGAPORE PTE. LTD.
03, Anson Road, #20-01, Springleaf Tower,
Singapore 079909
Phone : +65-6324-6113
Fax : +65-6324-6123
<http://www.hirose.com/sg/>

MALAYSIA:

PENANG REPRESENTATIVE OFFICE
73-3-1, Ideal@The One, Jalan Mahsuri, Bayan
Lepas Penang, 11950, Malaysia
Phone : +604-648-5536
<http://www.hirose.com/sg/>

USA:

HIROSE ELECTRIC (U.S.A.), INC. DETROIT OFFICE (AUTOMOTIVE)
17197 N. Laurel Park Drive, Suite 253,
Livonia, MI 48152
Phone : +1-734-542-9963
Fax : +1-734-542-9964
<http://www.hirose.com/us/>

GERMANY:

HIROSE ELECTRIC EUROPE B.V. GERMAN BRANCH
Schoenbergstr. 20, 73760 ostfildern
Phone : +49-711-456002-1
Fax : +49-711-456002-299
<http://www.hirose.com/eu/>

FRANCE:

HIROSE ELECTRIC EUROPE B.V. PARIS OFFICE
130 Avenue Joseph Kessel, Bat E, 78960
Voisins le Bretonneux, France
Phone : +33-1-85764886
Fax : +33-1-85764823
<http://www.hirose.com/eu/>

CHINA:

HIROSE ELECTRIC (SHANGHAI) CO.,LTD. BEIJING BRANCH
A1001, Ocean International Center, Building 56# East 4th
Ring Middle Road, ChaoYang District, Beijing, 100025
Phone : +86-10-5165-9332
Fax : +86-10-5908-1381
<http://www.hirose.com/cn/>

TAIWAN:

HIROSE ELECTRIC TAIWAN CO., LTD.
103 8F, No.87, Zhengzhou Rd., Taipei
Phone : +886-2-2555-7377
Fax : +886-2-2555-7355
<http://www.hirose.com/tw/>

INDIA:

HIROSE ELECTRIC SINGAPORE PTE. LTD. DELHI LIAISON OFFICE
Office NO.552, Regus-Green Boulevard, Level5, Tower C,
Sec62, Plot B-9A, Block B, Noida, 201301, Uttar Pradesh, India
Phone : +91-12-660-8018
Fax : +91-120-4804949
<http://www.hirose.com/sg/>

THAILAND:

BANGKOK OFFICE (REPRESENTATIVE OFFICE)
Unit 4703, 47th FL., 1 Empire Tower, South Sathorn
Road, Yannawa, Sathorn, Bangkok 10120 Thailand
Phone : +66-2-686-1255
Fax : +66-2-686-3433
<http://www.hirose.com/sg/>

**HIROSE ELECTRIC CO.,LTD.**

2-6-3,Nakagawa Chuoh,Tsuzuki-Ku,Yokohama-Shi 224-8540,JAPAN
TEL: +81-45-620-3526 Fax: +81-45-591-3726
<http://www.hirose.com>
<http://www.hirose-connectors.com>

X-ON Electronics

Largest Supplier of Electrical and Electronic Components

Click to view similar products for [Board to Board & Mezzanine Connectors](#) category:

Click to view products by [Hirose](#) manufacturer:

Other Similar products are found below :

[589158040000018](#) [MDF7C-18P-2.54DSA\(55\)](#) [FCN-230C068-11](#) [FCN-268F012-G/BD](#) [FCN-268F036-G/BD](#) [FCN-268M012-G/0D](#) [FCN-268M024-G/1D](#) [FCN-723J004/1](#) [MIS-048-01-F-D-DP-K](#) [832-10-034-10-001000](#) [FX4C-80S-1.27DSA](#) [FCN-214Q030-G/0](#) [FCN-234P048-G/0](#) [FCN-235D050-G/C](#) [210-93-314-41-105000](#) [2-22603-0](#) [MDF7-40DP-2.54DSA\(55\)](#) [AXG720047](#) [MIT-114-03-F-D-K](#) [55323-1519](#) [DF33-2P-3.3DSA\(24\)](#) [YFT-20-05-H-03-SB-K](#) [503308-3040](#) [026-6203-PDB](#) [027-6203-PDB](#) [069159702701000](#) [10123981-102LF](#) [101A10019X](#) [55650-0588-C](#) [68682-310LF](#) [68684-306](#) [75140-7012](#) [87471-650](#) [YTW-30-07-H-Q-410-140](#) [FCN-268F024-G0D](#) [10124054-515LF](#) [68685-603](#) [8-1616154-3](#) [MIS-019-01-F-D](#) [FCN-268M024-G/3D](#) [FCN-268M036-G/BD](#) [20021832-06016C1LF](#) [KX15-20KLDL-E1000E](#) [AXE810124](#) [FCN-214J100-G/0](#) [FCN-230C068-E/S](#) [AXE812124](#) [AXE816124](#) [AXE720127](#) [354184](#)