

Jul.1.2019 Copyright 2019 HIROSE ELECTRIC CO., LTD. All Rights Reserved.
 In case of consideration for using Automotive equipment / device which demand high reliability, kindly contact our sales window correspondents.

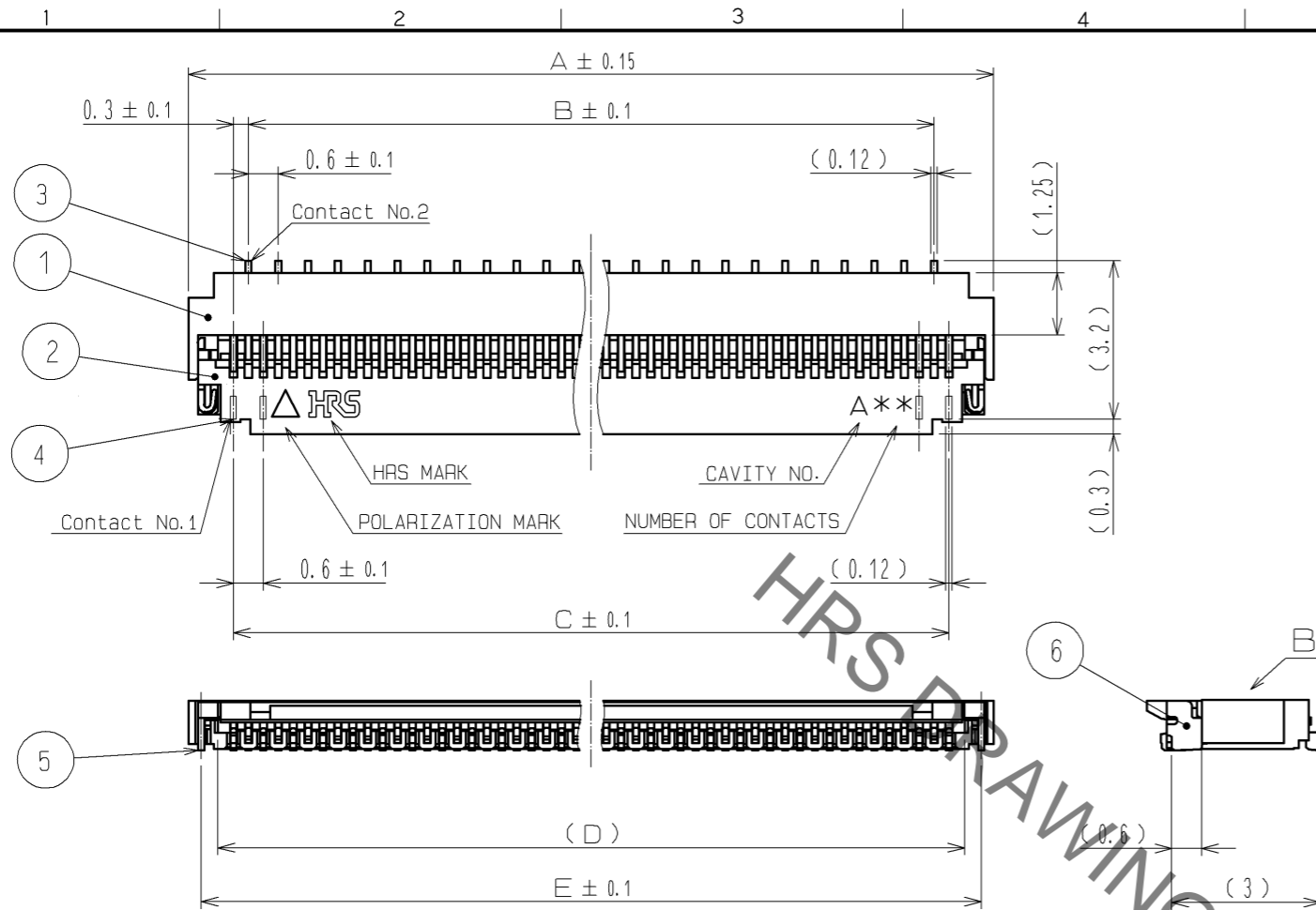

B (30 : 1)

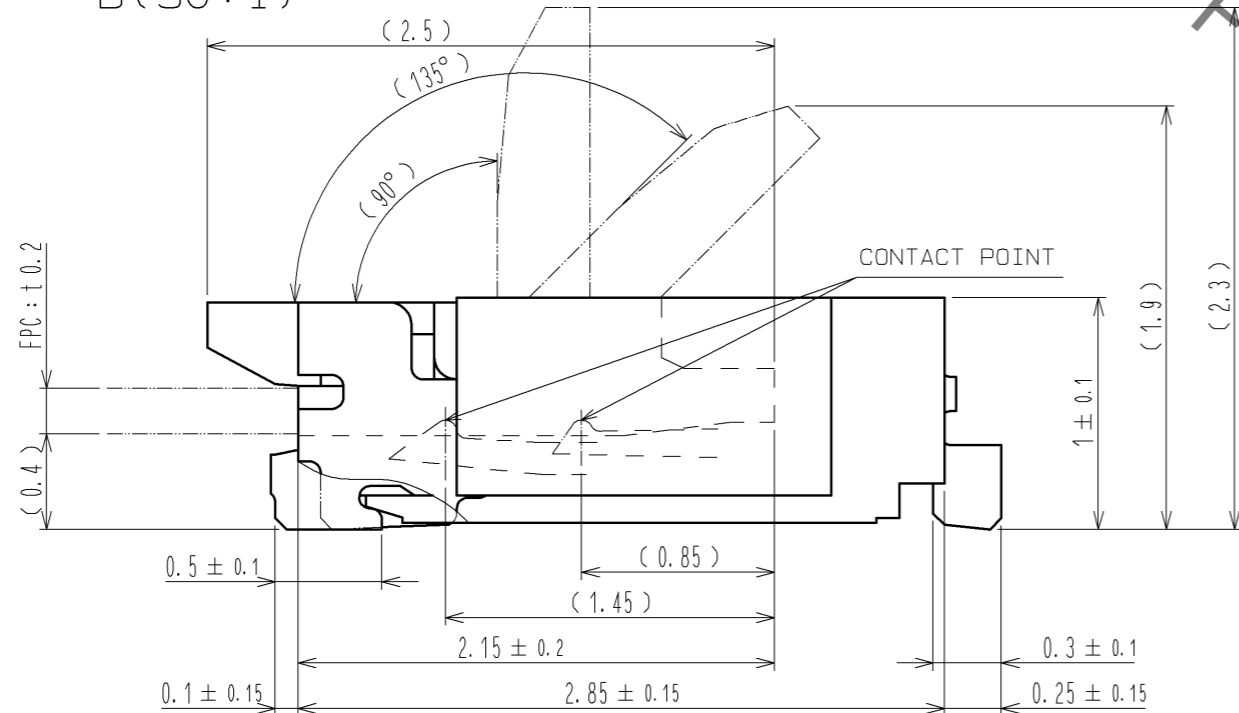

- NOTE
1. THE DIMENSIONS IN PARENTHESES ARE FOR REFERENCE.
 2. LEAD CO-PLANARITY INCLUDING REINFORCED METAL FITTINGS SHALL BE 0.1 MAX.
 3. TO BE DELIVERED WITH TAPE AND REEL PACKAGES.
SEE ATTACHED PACKAGING SPECIFICATIONS FOR DETAILS.
 4. NOTE THAT PREVENTIVE HOLE FOR SINK MARK COULD BE ADDED FOR IMPROVEMENT.
THE QUALITY REMAINS GOOD, EVEN WITH THE DARK SPOTS, WHICH COULD OCCASIONALLY OCCUR ON MOLDED PLASTIC.
 5. THIS PRODUCT SATISFIES HALOGEN FREE REQUIREMENTS DEFINED AS 900ppm MAXIMUM CHLORINE, 900ppm MAXIMUM BROMINE, AND 1500ppm MAXIMUM TOTAL OF CHLORINE AND BROMINE.
 6. 'n' REPRESENTS THE NUMBER OF CONTACTS.

RECOMMENDED PCB MOUNTING PATTERN (10 : 1)

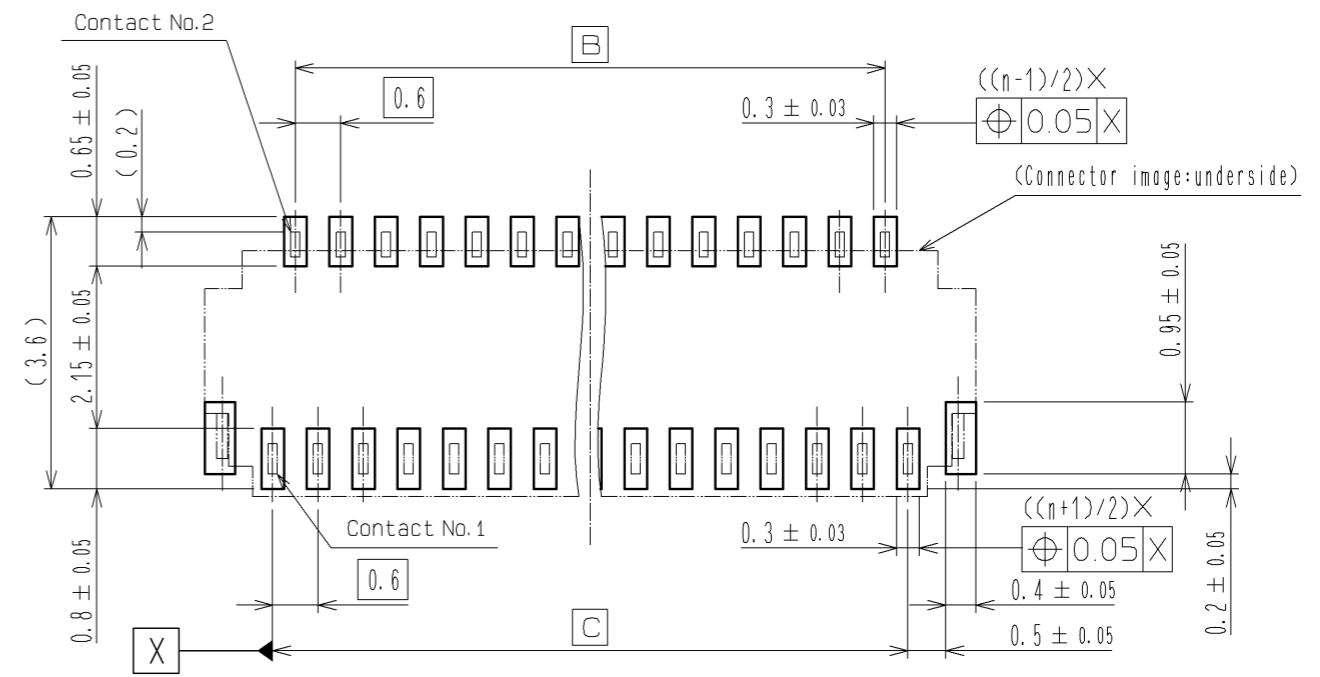

RECOMMENDED STENCIL PATTERN (10 : 1)

(RECOMMENDED STENCIL THICKNESS: t=0.1)

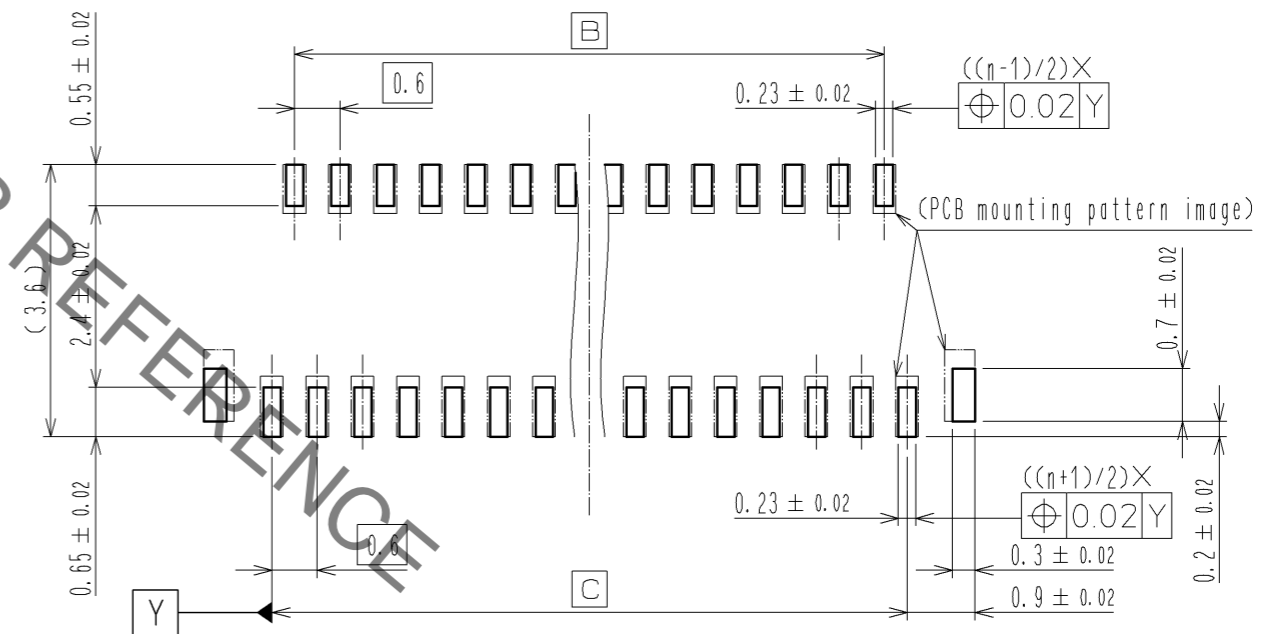

4	PHOSPHOR BRONZE	(CONTACT AREA-LEAD)GOLD PLATING 0.03#MMIN OVER NICKEL 1#MMIN (OTHER)NICKEL PLATING 1#MMIN	10 (CONNECTOR)
3	PHOSPHOR BRONZE	(CONTACT AREA-LEAD)GOLD PLATING 0.03#MMIN OVER NICKEL 1#MMIN (OTHER)NICKEL PLATING 1#MMIN	9 POLYSTYRENE
2	PA	LIGHT BROWN UL94HB	8 POLYESTER
1	LCP	BLACK UL94V-0	7 POLYSTYRENE
			6 PHOSPHOR BRONZE (PLATED MATERIAL)
			5 PHOSPHOR BRONZE (PLATED MATERIAL)
NO.	MATERIAL	FINISH . REMARKS	NO. MATERIAL FINISH . REMARKS

UNITS mm	SCALE 7 : 1	COUNT	DESCRIPTION OF REVISIONS	DESIGNED	CHECKED	DATE
			APPROVED : MO. ISHIDA 14. 04. 15			
			CHECED : HS. SAKAMOTO 14. 04. 15			
			DESIGNED : SG. MASAKI 14. 04. 15			
			DRAWN : NM. SANPEI 14. 04. 14			
HIROSE ELECTRIC CO., LTD.			DRAWING NO. EDC3-323714-05 PART NO. FH26W-**S-0.3SHW(60) CODE NO. CL580			

Jul.1.2019 Copyright 2019 HIROSE ELECTRIC CO., LTD. All Rights Reserved.
 In case of consideration for using Automotive equipment / device which demand high reliability, kindly contact our sales window correspondents.

RECOMMENDED FPC(FREE) (SCALE:FREE)

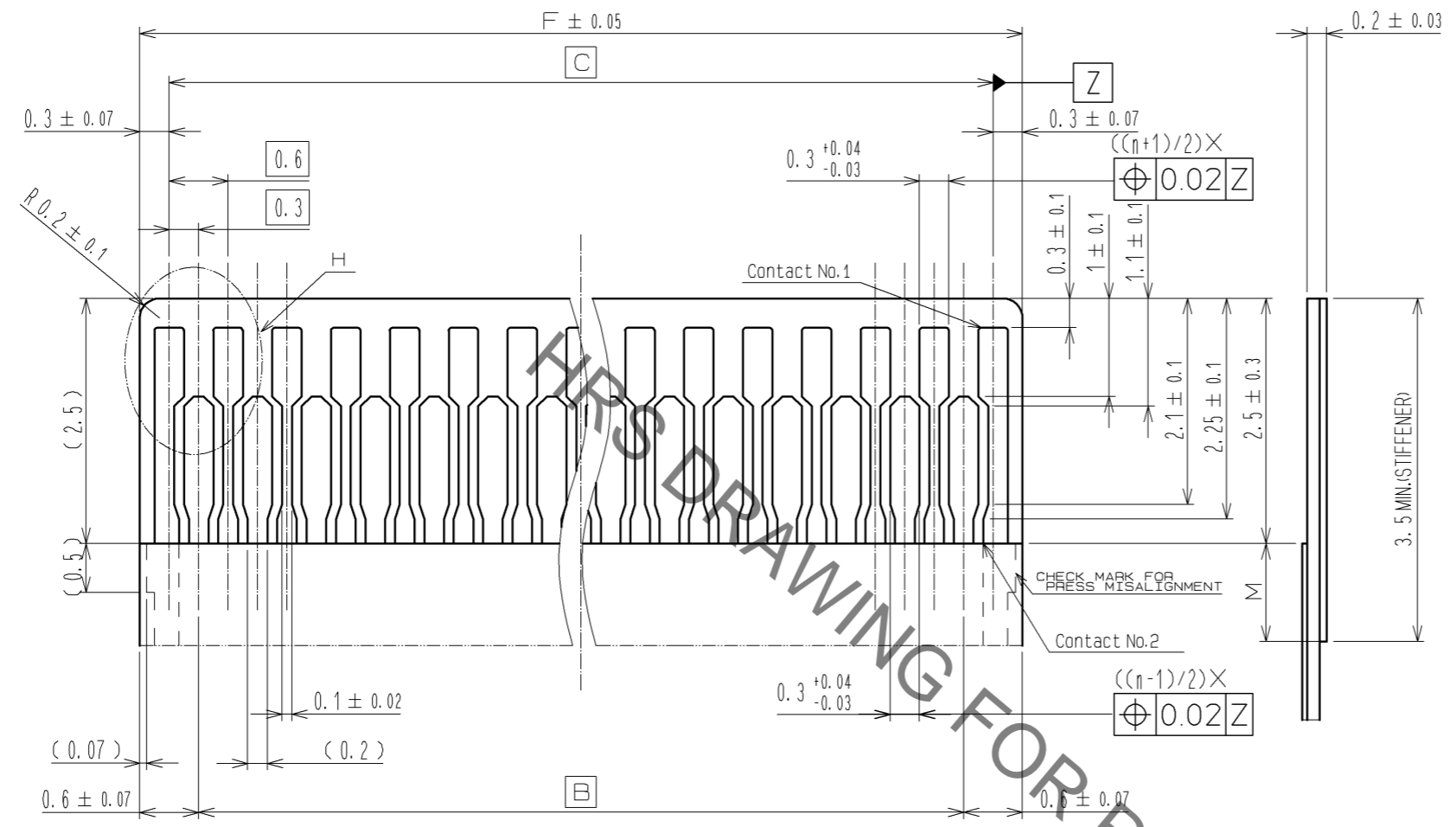

DIMENSION M MUST BE 0.5mm MINIMUM WHEN THE STIFFENER IS SHORTER THAN 3.5mm.

FPC CONFIGURATION (REFERENCE EXAMPLE)
 (SCALE:FREE)

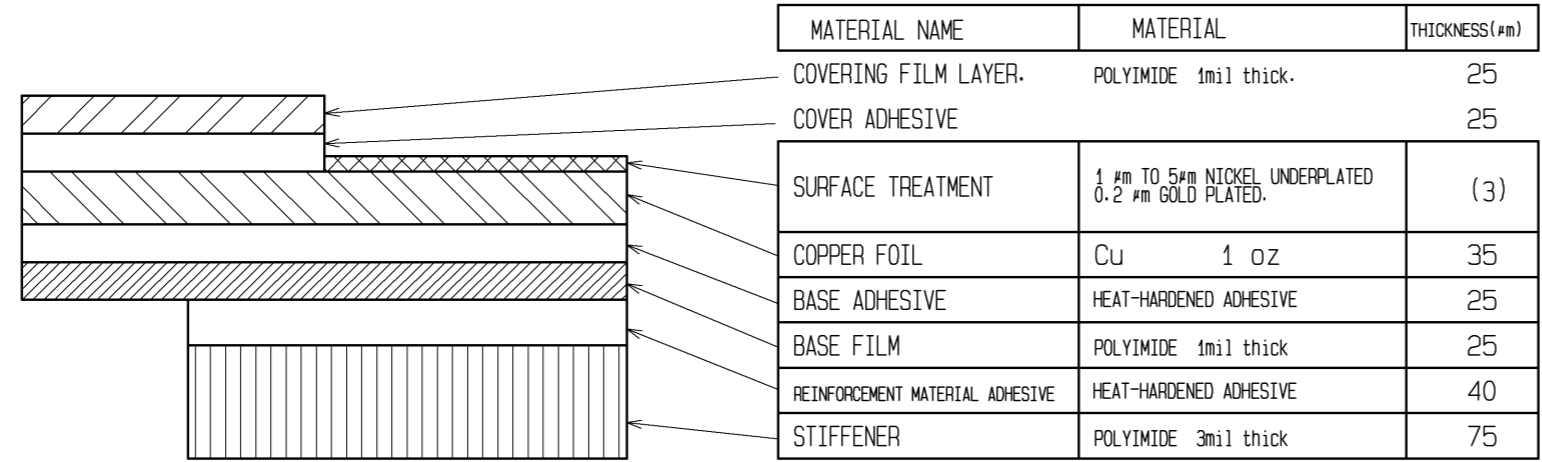

HRS	DRAWING NO.	EDC3-323714-05
	PART NO.	FH26W-**S-0.3SHW(60)
	CODE NO.	CL580
		2/6

Jul.1.2019 Copyright 2019 HIROSE ELECTRIC CO., LTD. All Rights Reserved.
 In case of consideration for using Automotive equipment / device which demand high reliability, kindly contact our sales window correspondents.

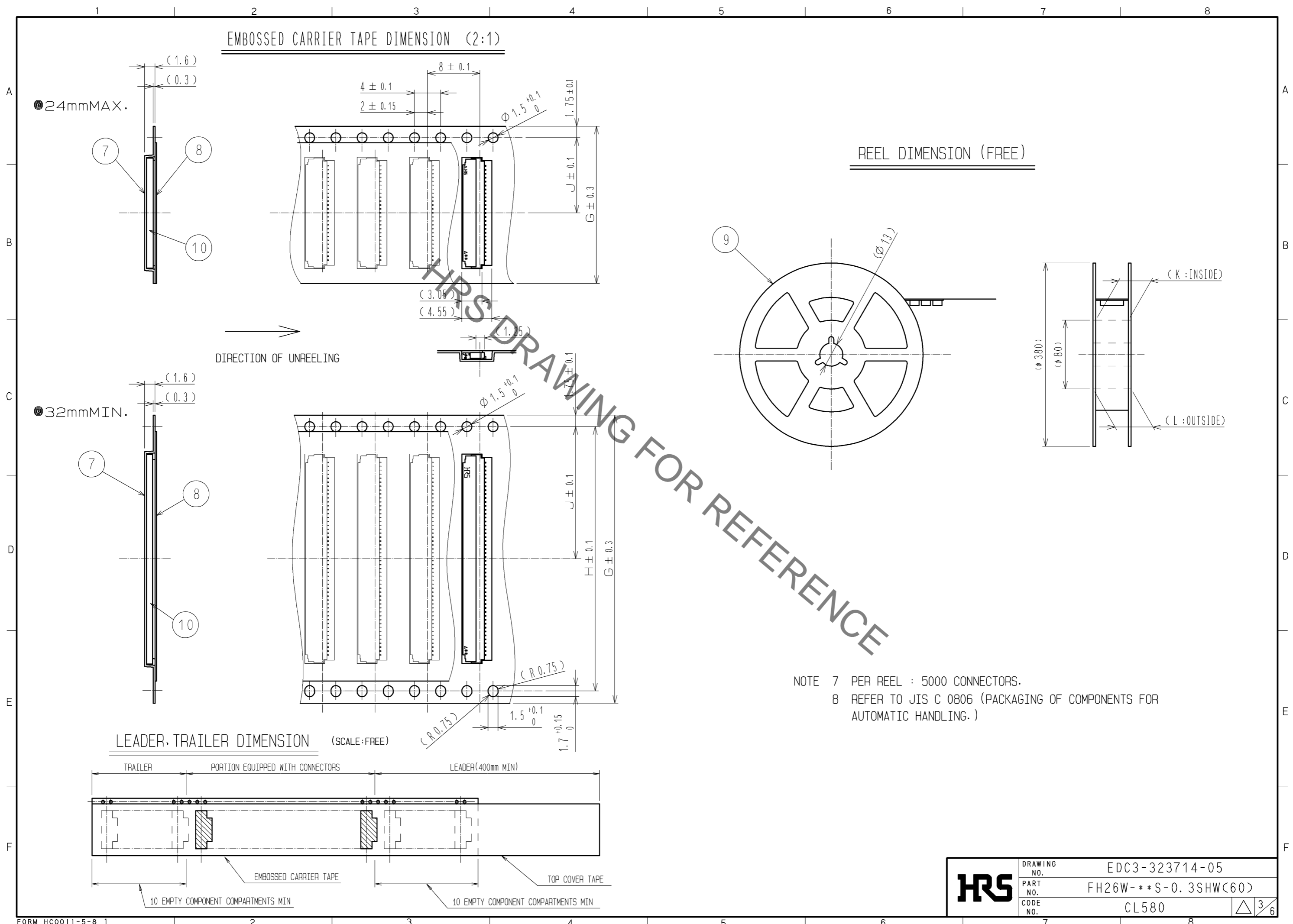

HRS	DRAWING NO.	EDC3-323714-05
	PART NO.	FH26W-**S-0.3SHW(60)
	CODE NO.	CL580
		△ 3/6

Jul.1.2019 Copyright 2019 HIROSE ELECTRIC CO., LTD. All Rights Reserved.
 In case of consideration for using Automotive equipment / device which demand high reliability, kindly contact our sales window correspondents.

PART NUMBER	CL	NUMBER OF CONTACT	DIMENSION OF CONNECTOR, FPC PATTERN AND METAL MASK						DIMENSION OF DRAWING FOR PACKING				
			A	B	C	D	E	F	G	H	J	K	L
FH26W-13S-0.3SHW(60)	CL580-2401-1-60	13	5.4	3.0	3.6	4.23	4.9	4.2	16	-	7.5	17.4	21.4
FH26W-15S-0.3SHW(60)	CL580-2402-4-60	15	6.0	3.6	4.2	4.83	5.5	4.8	16	-	7.5	17.4	21.4
FH26W-17S-0.3SHW(60)	CL580-2403-7-60	17	6.6	4.2	4.8	5.43	6.1	5.4	16	-	7.5	17.4	21.4
FH26W-19S-0.3SHW(60)	CL580-2404-9-60	19	7.2	4.8	5.4	6.03	6.7	6.0	16	-	7.5	17.4	21.4
FH26W-21S-0.3SHW(60)	CL580-2405-12-60	21	7.8	5.4	6.0	6.63	7.3	6.6	16	-	7.5	17.4	21.4
FH26W-23S-0.3SHW(60)	CL580-2406-15-60	23	8.4	6.0	6.6	7.23	7.9	7.2	16	-	7.5	17.4	21.4
FH26W-25S-0.3SHW(60)	CL580-2407-18-60	25	9.0	6.6	7.2	7.83	8.5	7.8	16	-	7.5	17.4	21.4
FH26W-27S-0.3SHW(60)	CL580-2408-21-60	27	9.6	7.2	7.8	8.43	9.1	8.4	16	-	7.5	17.4	21.4
FH26W-29S-0.3SHW(60)	CL580-2409-24-60	29	10.2	7.8	8.4	9.03	9.7	9.0	24	-	11.5	25.4	29.4
FH26W-31S-0.3SHW(60)	CL580-2410-27-60	31	10.8	8.4	9.0	9.63	10.3	9.6	24	-	11.5	25.4	29.4
FH26W-33S-0.3SHW(60)	CL580-2411-30-60	33	11.4	9.0	9.6	10.23	10.9	10.2	24	-	11.5	25.4	29.4
FH26W-35S-0.3SHW(60)	CL580-2412-33-60	35	12.0	9.6	10.2	10.83	11.5	10.8	24	-	11.5	25.4	29.4
FH26W-37S-0.3SHW(60)	CL580-2413-36-60	37	12.6	10.2	10.8	11.43	12.1	11.4	24	-	11.5	25.4	29.4
FH26W-39S-0.3SHW(60)	CL580-2414-39-60	39	13.2	10.8	11.4	12.03	12.7	12.0	24	-	11.5	25.4	29.4
FH26W-41S-0.3SHW(60)	CL580-2415-42-60	41	13.8	11.4	12.0	12.63	13.3	12.6	24	-	11.5	25.4	29.4
FH26W-45S-0.3SHW(60)	CL580-2416-45-60	45	15.0	12.6	13.2	13.83	14.5	13.8	24	-	11.5	25.4	29.4
FH26W-51S-0.3SHW(60)	CL580-2417-51-60	51	16.8	14.4	15.0	15.63	16.3	15.6	24	-	11.5	25.4	29.4
FH26W-55S-0.3SHW(60)	CL580-2418-55-60	55	18.0	15.6	16.2	16.83	17.5	16.8	32	28.4	14.2	33.4	37.4
FH26W-57S-0.3SHW(60)	CL580-2419-57-60	57	18.6	16.2	16.8	17.43	18.1	17.4	32	28.4	14.2	33.4	37.4
FH26W-61S-0.3SHW(60)	CL580-2420-61-60	61	19.8	17.4	18.0	18.63	19.3	18.6	32	28.4	14.2	33.4	37.4
FH26W-71S-0.3SHW(60)	CL580-2421-71-60	71	22.8	20.4	21.0	21.63	22.3	21.6	44	40.4	20.2	45.4	49.4

HRS	DRAWING NO.	EDC3-323714-05
	PART NO.	FH26W-**S-0.3SHW(60)
	CODE NO.	CL580

△ 4/6

Jul.1.2019 Copyright 2019 HIROSE ELECTRIC CO., LTD. All Rights Reserved.
In case of consideration for using Automotive equipment / device which demand high reliability, kindly contact our sales window correspondents.

This connector is small and thin and requires delicate and careful handling.
Read through the instructions shown below and handle the connector properly.
Each values indicating here are for reference and may differ from standard value.

[INSTRUCTIONS FOR MOUNTING ON THE BOARD]

◆Warp of Board

Minimize warp of the board as much as possible.
Lead co-planarity including reinforced metal fittings is 0.1 mm or less.
Too much warp of the board may result in a soldering failure.

◆Flexible board design

Please make sure to put a stiffener on the backside of the flexible board.
We recommend a glass epoxy material with the thickness of 0.3mm MIN.

◆Load to Connector

Do not add 0.5N or greater external force when unreel or pick and place the connector etc.
or it may get broken.
In addition, do not insert the FPC or operate the connector before mounting it.

[INSTRUCTIONS FOR PCB HANDLING AFTER MOUNTING THE CONNECTOR]

◆Load to Board

·Splitting a large board into several pieces
·Screwing the board
Avoid the handling described above so that no force is exerted on the board during the assembly process.
Otherwise, the connector may become defective.

◆Amount of Warp

The warp of a 100-mm wide board should be 0.5 mm or less.
The warp of board suffers stress on connector and the connector may become defective.

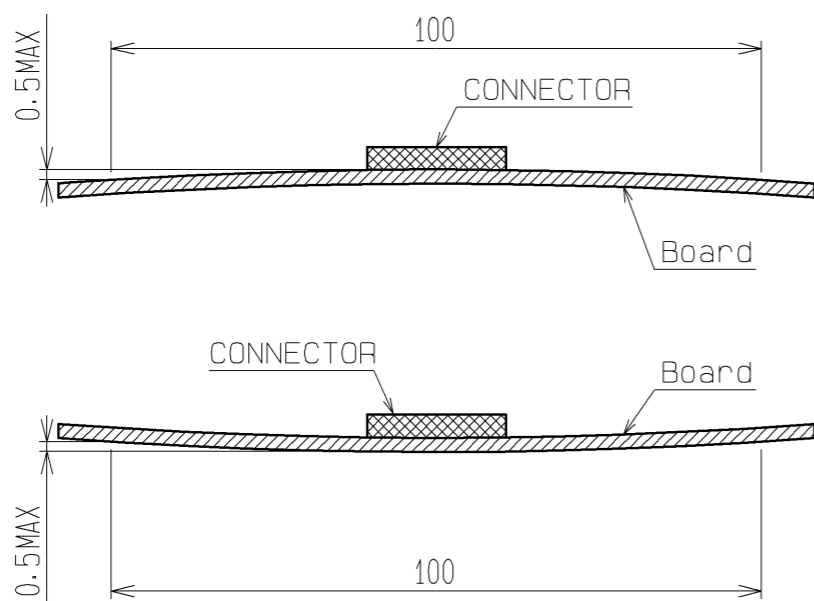

[INSTRUCTIONS ON INSERTING FPC AND CONNECTION]

◆ Use of the actuator

1. Be very careful not to apply excessive force when releasing the actuator in the initial position (with no FPC inserted).
If you use your nail or finger as shown below, the terminals may be deformed.

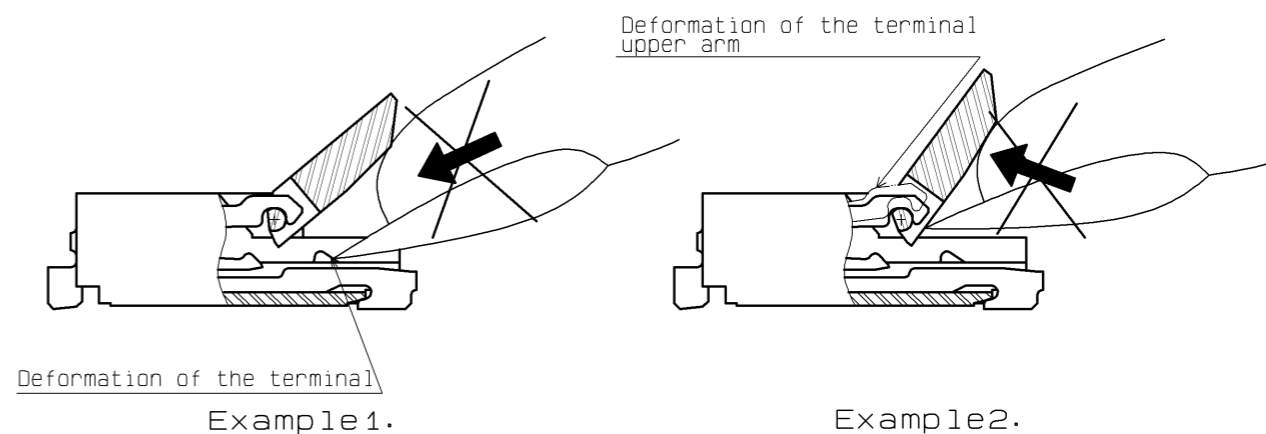

2. The actuator rotates around the rotational axis as shown below.
Rotate the actuator.

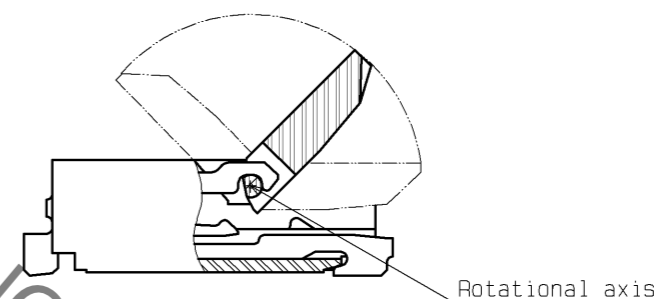

3. The actuator will not open more than 135°.
Do not apply any force backward beyond this point.
Otherwise, the actuator may come off or break.

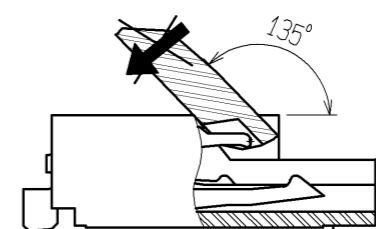

HRS	DRAWING NO.	EDC3-323714-05
	PART NO.	FH26W-**S-0.3SHW(60)
	CODE NO.	CL580
		△ 5/6

Jul.1.2019 Copyright 2019 HIROSE ELECTRIC CO., LTD. All Rights Reserved.
In case of consideration for using Automotive equipment / device which demand high reliability, kindly contact our sales window correspondents.

- 4. Move the actuator at approximately the center.
- 5. Do not pinch or pick the actuator to lift it as shown below. Otherwise, it may break.
(Do not carry out any operation other than rotating the actuator as shown in 2 above.)

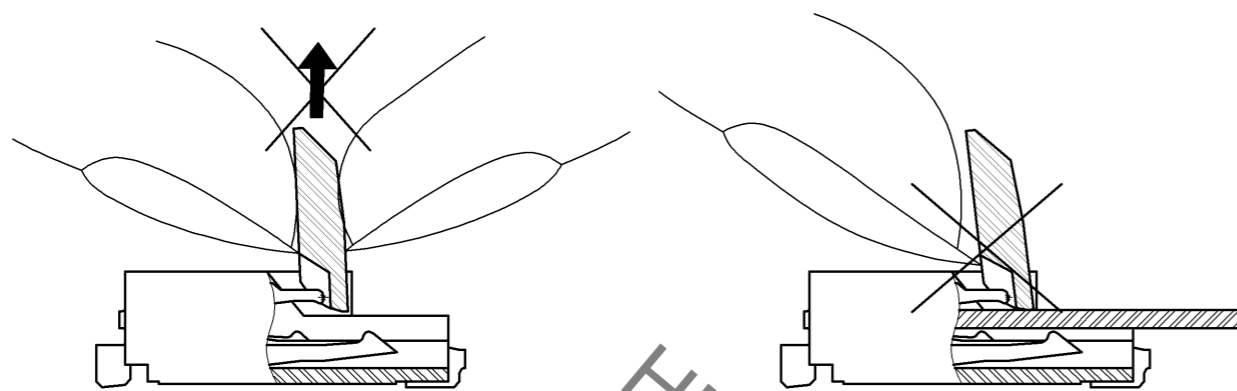

[INSTRUCTIONS ON FPC LAYOUT AFTER CONNECTION]

◆Load to FPC

Be very careful not to apply any force to the FPC after inserting it. Otherwise, the connector may become unlocked or the FPC may break. Fix the FPC, in particular, when loads are applied to it continuously. Design the FPC layout with care not to bend it sharply near the insertion opening.

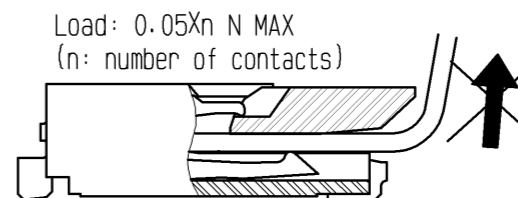

◆Direction of Contacts

This connector has contacts on the bottom. Thus, insert the FPC with the exposed conductors face down.

◆Inserting the FPC

- 1. Insert the FPC horizontally along the surface and at a right angle to the connector. Insert it properly to the very end. If the FPC is inserted at a slant (incorrectly), the conductors may short-circuit due to pitch shift or the edge of the FPC may catch in the terminals, resulting in deformation of the terminals. This connector has a ZIF structure, and its effective engagement length is 0.35 mm (when the recommended FPC nominal is used). Use the actuator carefully to prevent the FPC from dislocating after inserting it.

- 2. Do not insert the FPC diagonally from above. If the FPC is inserted at a slant (incorrectly) as shown below in the FPC insertion process, the FPC may bend and patterns may break or the FPC may not insert completely, resulting in improper conduction.

※Keep a sufficient FPC insertion space in the stage of the layout in order to avoid incorrect FPC insertion. Besides, it is not difficult to insert FPC correctly all the way to the end. Design the proper layout of parts.

※Make adjustments with the FPC manufacturer for FPC bending performance and wire breakage.

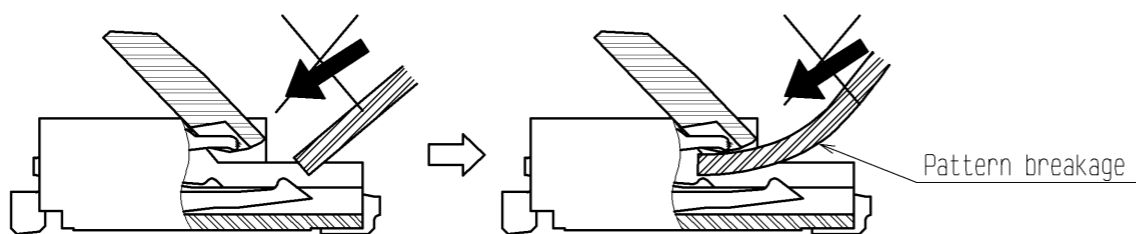

[INSTRUCTIONS ON REMOVING FPC]

- ◆Release the actuator to remove the FPC.

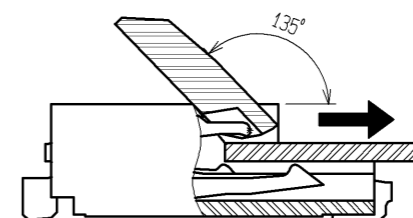

◆Instructions on Manual Soldering

- Follow the instructions shown below when soldering the connector manually during repair work, etc.
- 1. Do not perform reflow soldering or manual soldering with the FPC inserted into the connector.
 - 2. Do not heat the connector excessively. Be very careful not to let the soldering iron contact any parts other than connector leads. Otherwise, the connector may be deformed or melt.
 - 3. Do not use excessive solder (or flux).
- If excessive solder (or flux) is used on the terminals, solder or flux may adhere to the contacts or rotating parts of the actuator, resulting in poor contact or a rotation failure of the actuator. Supplying excessive solder to the reinforcing bracket may hinder actuator rotation, resulting in breakage of the connector.

◆Checking the Locking Condition

In the locked condition, make sure that the actuator is horizontal on the board surface. Do not apply excessive force to it near the 0° position of the actuator. Otherwise, the terminals may be deformed. (Allowable force: 1 N or less)

HRS	DRAWING NO.	EDC3-323714-05
	PART NO.	FH26W-**S-0.3SHW(60)
	CODE NO.	CL580
		△ 6/6

HRS DRAWING FOR REFERENCE

X-ON Electronics

Largest Supplier of Electrical and Electronic Components

Click to view similar products for [FFC & FPC Connectors](#) category:

Click to view products by [Hirose](#) manufacturer:

Other Similar products are found below :

[HFW11R-1STE1H1LF](#) [FH29B-100S-0.2SHW\(99\)](#) [FA5S008HP1](#) [FH29B-120S-0.2SHW\(99\)](#) [FH29B-80S-0.2SHW\(99\)](#) [FHS-16](#) [FPH-2022G](#)
[52610-1075](#) [52610-1275](#) [52610-1934](#) [XF3M\(1\)-1415-1B-R100](#) [501864-3091-TR225](#) [0525594033](#) [086210010340800](#) [086222026001800](#)
[52271-2869-CUT-TAPE](#) [62674-201121DLF](#) [62684-36210E9ALF](#) [52610-1675](#) [52746-1671-TR250](#) [10051922-2810EHLF](#) [6-520415-9](#)
[BD021-09A-A1-0350-0200-0550-LD](#) [SFV6R-1STE9HLF](#) [XF3M-2915-1B-R100](#) [1658549-1](#) [62674-221121ALF](#) [46214008010800](#)
[046298003000883](#) [151660622](#) [842-816-2630-035](#) [AYF530665TA](#) [AYF351525](#) [046296011930846+](#) [AYF352325A](#) [046254020000800+](#)
[FH19C-13S-0.5SH\(99\)](#) [FH39J-51S-0.3SHW\(99\)](#) [AYF355125A](#) [AYF530365TA](#) [FH29B-44S-0.2SHW\(99\)](#) [SFW5R-2STAE9LF](#) [AYF351125A](#)
[AYF350725A](#) [62684-502100AHLF](#) [FH39-61S-0.3SHW\(99\)](#) [AYF414035A](#) [10064555-172520HLF](#) [AYF212335A](#) [504754-2500](#)