

0.3mm Pitch 1.1mm Height Top and Bottom Contact Back-Flip actuator Flexible Printed Circuit Connectors

FH39 Series

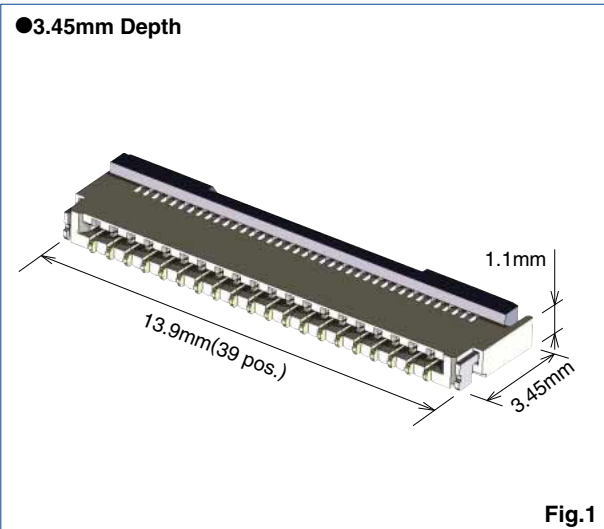

■Features

1. Low-profile 0.3mm pitch connector with top and bottom contact

Usable via either its top or bottom contact point, this connector achieves enhanced freedom in terms of the product design.

2. High contact reliability thanks to the spring terminal structure

Because both top and bottom contact points are spring-loaded, the contact point adapts to the FPC motion, and high contact reliability is ensured.

3. Delivered with the actuator open

FPC can be immediately inserted without the need for the opening of the actuator. (Fig.2)

4. Easy FPC insertion

Entry chamfers at all sides of the FPC insertion slot assure correct insertion and positioning of the FPC.

5. Accepts standard FPC thickness

0.2mm thick standard Flexible Printed Circuit (FPC) can be used. This is the only ultra-low profile ZIF connector using standard FPC.

6. Conductive traces on the PCB can run under the connector

No exposed contacts on the bottom of the connector.

7. Board placement with automatic equipment

Flat upper surface and tape and reel packaging facilitate vacuum pick-up and placement. Standard reel packaging contains 5000 connectors.

8. Halogen-free* (FH39J Series)

*As defined by IEC61249-2-21

Br-900ppm maximum, Cl-900ppm maximum,
Cl + Br combined-1,500ppm maximum

●Easy FPC insertion

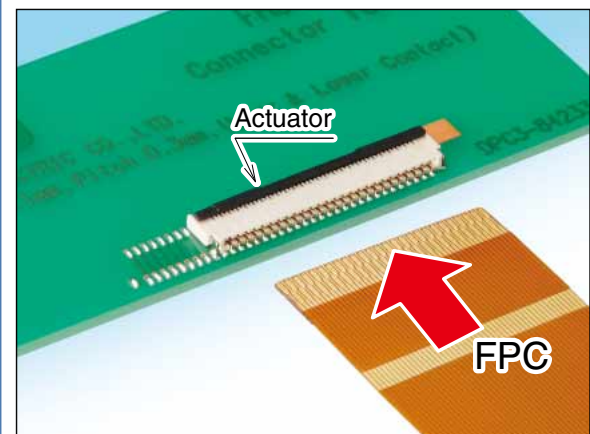

●Completely locked

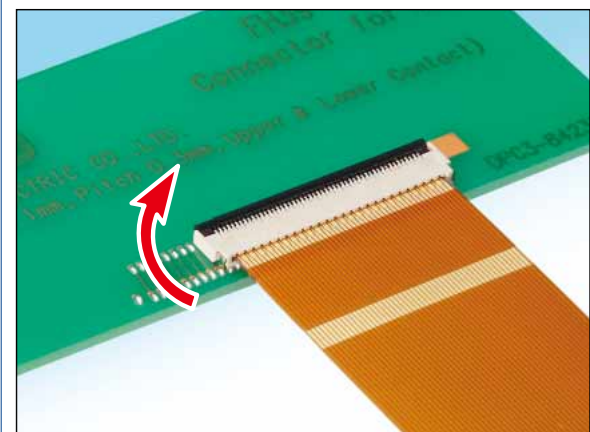

Product Specifications

Ratings	Current rating	0.2A	Operating temperature range	-55 to +85°C (Note 1)	Storage temperature range	-10 to +50°C (Note 2)
	Voltage rating	30Vrms AC	Operating humidity range	Relative humidity 90% max. (No condensation)	Storage humidity range	Relative humidity 90% max. (No condensation)

Recommended FPC	Thickness: 0.2 ± 0.03mm, Gold plated contact pads
-----------------	---

Item	Specification	Conditions
1. Insulation resistance	50MΩ min.	100V DC
2. Withstanding voltage	No flashover or insulation breakdown	90Vrms AC / 1 minute
3. Contact resistance	100mΩ max. * Including FPC and FFC conductor resistance	1mA, AC max (AC: 1kHz)
4. Durability	Contact resistance : 100mΩ max. No damage, cracks, or parts dislocation	10 cycles
5. Vibration	No electrical discontinuity of 1μs or longer Contact resistance : 100mΩ max. No damage, cracks, or parts dislocation	Frequency : 10 to 55Hz, single amplitude of 0.75mm, 10 cycles in each of the 3 axis
6. Shock	No electrical discontinuity of 1μs or longer Contact resistance : 100mΩ max. No damage, cracks, or parts dislocation	Acceleration of 981m/s ² , 6ms duration, sine half-wave, 3 cycles in each of the 3 axis
7. Humidity (Steady state)	Contact resistance : 100mΩ max. Insulation resistance : 50MΩ min. No damage, cracks, or parts dislocation	96 hours at 40°C and humidity of 90 to 95%
8. Temperature cycle	Contact resistance : 100mΩ max. Insulation resistance : 50MΩ min. No damage, cracks, or parts dislocation	Temperature : -55°C → +15°C → +35°C → +85°C → +15°C → +35°C Time : 30 → 2 to 3 → 30 → 2 to 3 minutes 5 cycles
9. Resistance to soldering heat	No deformation of components affecting performance	Reflow : At the recommended temperature profile Manual soldering : 350°C ± 5°C for 5 seconds

Note 1 : Includes temperature rise caused by current flow.

Note 2 : The term "storage" refers to products stored for a long period prior to mounting and use.

The operating temperature and humidity range covers the non-conducting condition of installed connectors in storage, shipment or during transportation after board mounting.

Materials / Finish

Part	Material	Finish	Remarks
Insulator	LCP	Color : Beige	UL94V-0
	PA	Color : Black	
Contacts	Phosphor bronze	Gold plated	_____
Metal fittings		Pure tin reflow plated	_____

Product Number Structure

FH 39 J - 51S - 0.3 SHW (10)

①
②
③
④
⑤
⑥
⑦

① Series name : FH	④ No. of Contacts FH39 : 25 to 61 FH39A : 67 FH39J : 25 to 51
② Series No. : 39	
③ Blank : Standard A : Long actuator type J : Halogen-free (Flame retardance UL94V-0).	
	⑤ Contact pitch : 0.3mm
	⑥ Termination type SHW...SMT horizontal staggered row mount type
	⑦ Plating specifications (10)...Standard 5,000 pcs/reel (99)...500 pcs/reel

Connector Dimensions

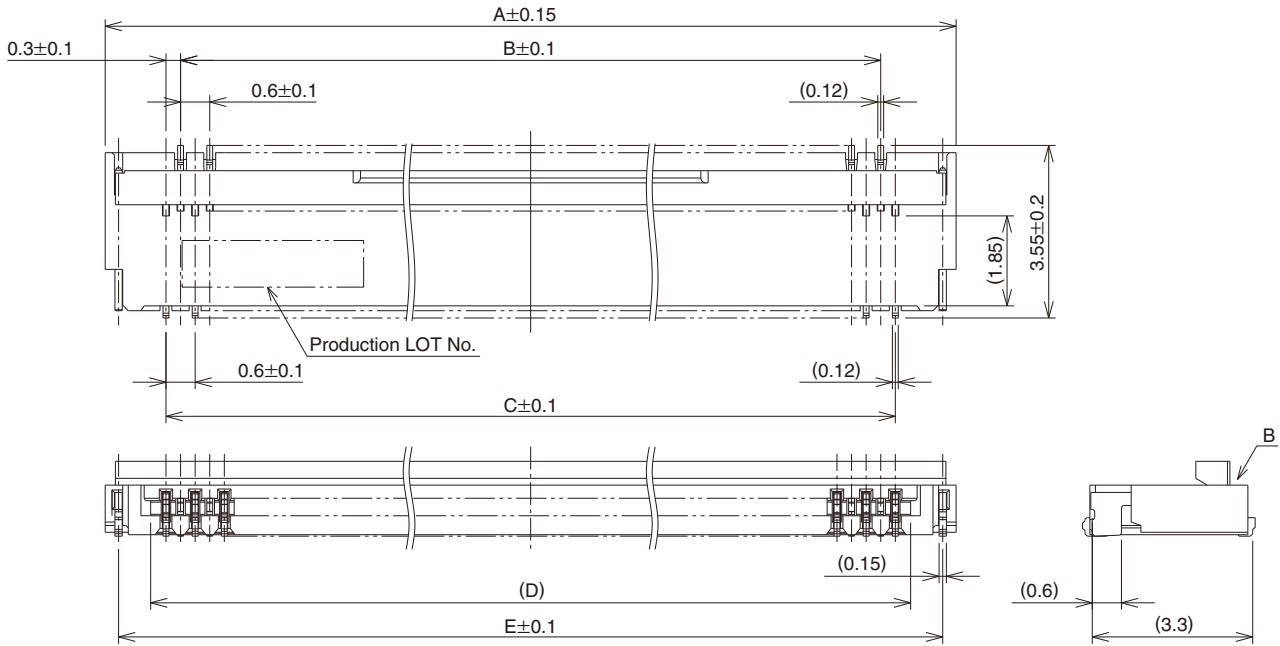

B Detailed drawing [FH39 Series]

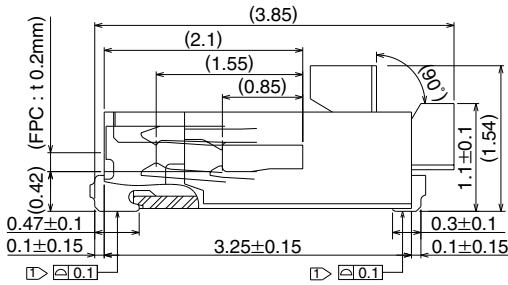

B Detailed drawing [FH39A Series]

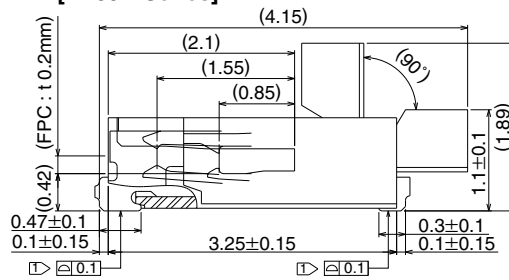

Note 1: The coplanarity of each terminal lead within specified dimension is 0.1 mm Max.

- 2 : Packaged on tape and reel only. Check packaging specification.
- 3 : Slight variations in color of the plastic compounds do not affect form, fit or function of the connector.
- 4 : After reflow, the terminal plating may change color, however this does not represent a quality issue.

All dimensions : mm

Part No.	HRS No.	No. of Contacts	A	B	C	D	E
FH39-25S-0.3SHW(10)	580-1806-8 10	25	9.7	6.6	7.2	7.83	9.15
FH39-27S-0.3SHW(10)	580-1805-5 10	27	10.3	7.2	7.8	8.43	9.75
FH39-29S-0.3SHW(10)	580-1807-0 10	29	10.9	7.8	8.4	9.03	10.35
FH39-33S-0.3SHW(10)	580-1803-0 10	33	12.1	9	9.6	10.23	11.55
FH39-39S-0.3SHW(10)	580-1800-1 10	39	13.9	10.8	11.4	12.03	13.35
FH39-45S-0.3SHW(10)	580-1802-7 10	45	15.7	12.6	13.2	13.83	15.15
FH39-51S-0.3SHW(10)	580-1801-4 10	51	17.5	14.4	15	15.63	16.95
FH39-61S-0.3SHW(10)	580-1808-3 10	61	20.5	17.4	18	18.63	19.95
FH39A-67S-0.3SHW(10)	580-1809-6 10	67	22.3	19.2	19.8	20.43	21.75
FH39J-25S-0.3SHW(10)	580-1815-9 10	25	9.7	6.6	7.2	7.83	9.15
FH39J-33S-0.3SHW(10)	580-1814-6 10	33	12.1	9	9.6	10.23	11.55
FH39J-39S-0.3SHW(10)	580-1813-3 10	39	13.9	10.8	11.4	12.03	13.35
FH39J-45S-0.3SHW(10)	580-1811-8 10	45	15.7	12.6	13.2	13.83	15.15
FH39J-51S-0.3SHW(10)	580-1812-0 10	51	17.5	14.4	15	15.63	16.95

Note 1 : Tape and reel packaging (5,000 pcs/reel, 500 pcs/reel).

Note 2 : Order by number of reels.

Recommended PCB mounting pattern and metal mask dimensions

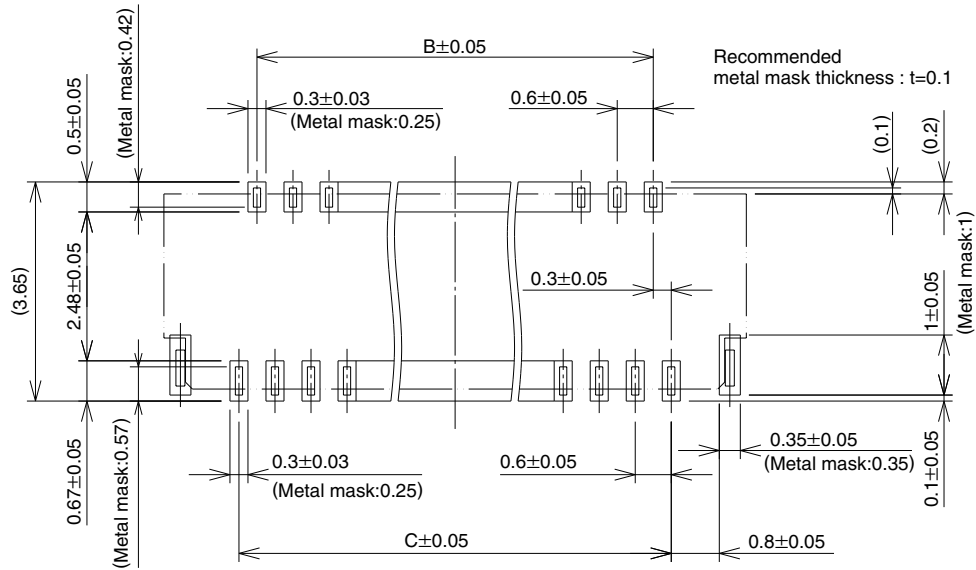

Recommended FPC Dimensions

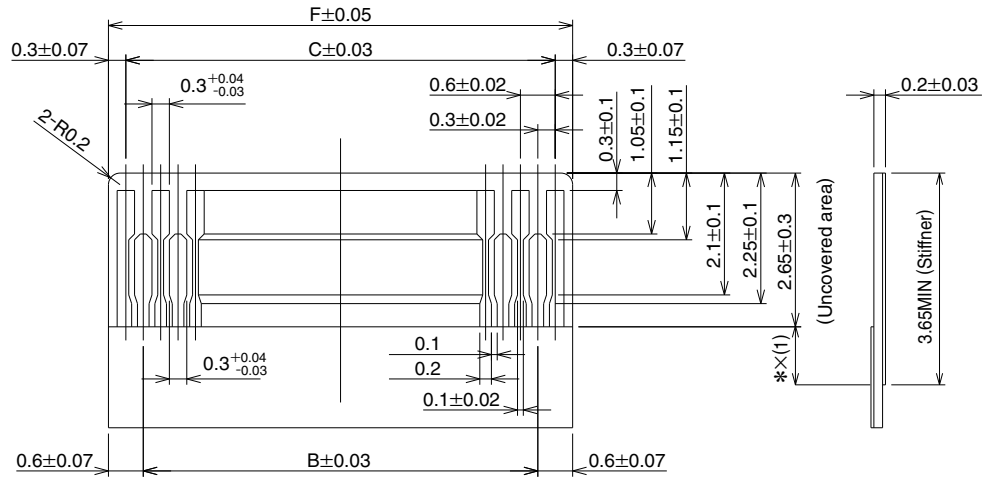

Note : Stiffener dimension should be 3.65mm min., however if it is not satisfied, X dimension should be 0.5mm or more.

All dimensions : mm

Part No.	HRS No.	No. of Contacts	B	C	F
FH39-25S-0.3SHW(10)	580-1806-8 10	25	6.6	7.2	7.8
FH39-27S-0.3SHW(10)	580-1805-5 10	27	7.2	7.8	8.4
FH39-29S-0.3SHW(10)	580-1807-0 10	29	7.8	8.4	9
FH39-33S-0.3SHW(10)	580-1803-0 10	33	9	9.6	10.2
FH39-39S-0.3SHW(10)	580-1800-1 10	39	10.8	11.4	12
FH39-45S-0.3SHW(10)	580-1802-7 10	45	12.6	13.2	13.8
FH39-51S-0.3SHW(10)	580-1801-4 10	51	14.4	15	15.6
FH39-61S-0.3SHW(10)	580-1808-3 10	61	17.4	18	18.6
FH39A-67S-0.3SHW(10)	580-1809-6 10	67	19.2	19.8	20.4
FH39J-25S-0.3SHW(10)	580-1815-9 10	25	6.6	7.2	7.8
FH39J-33S-0.3SHW(10)	580-1814-6 10	33	9	9.6	10.2
FH39J-39S-0.3SHW(10)	580-1813-3 10	39	10.8	11.4	12
FH39J-45S-0.3SHW(10)	580-1811-8 10	45	12.6	13.2	13.8
FH39J-51S-0.3SHW(10)	580-1812-0 10	51	14.4	15	15.6

◆ Recommended FPC construction

1. Using Single-sided FPC

FPC : Flexible Printed Circuit

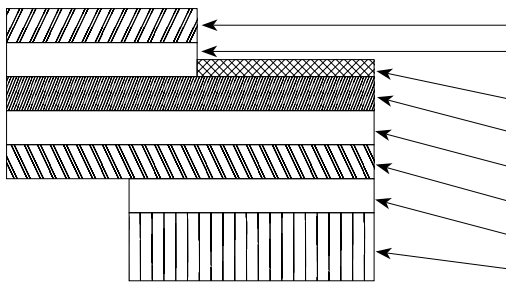

Material Name	Material	Material Thickness(μm)
Covering film layer	Polyimide 1 mil thick.	(25)
Cover adhesive		(25)
Surface treatment	0.2μm thick gold plated over 1 to 5μm nickel underplating	3
Copper foil	Cu 1oz	35
Base adhesive	Thermosetting adhesive	25
Base film	Polyimide 1 mil thick	25
Reinforcement material adhesive	Thermosetting adhesive	40
Stiffener	Polyimide 3 mil thick	75
Total		203

2. Using Double-sided FPC

FPC : Flexible Printed Circuit

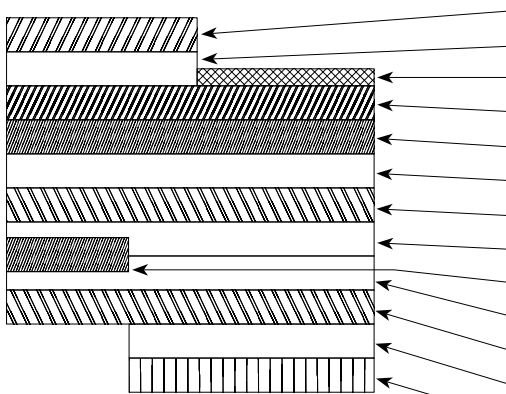

Material Name	Material	Material Thickness (μm)
Covering film layer	Polyimide 1 mil thick.	(25)
Cover adhesive		(25)
Surface treatment	0.2μm thick gold plated over 1 to 5μm nickel underplating	3
Through-hole copper	Cu	15
Copper foil	Cu 1/2oz	18
Base adhesive	Thermosetting adhesive	18
Base film	Polyimide 1 mil thick	25
Base adhesive	Thermosetting adhesive	18
Copper foil	Cu 1/2oz	(18)
Cover adhesive	Thermosetting adhesive	25
Covering film layer	Polyimide 1 mil thick.	25
Reinforcement material adhesive	Thermosetting adhesive	25
Stiffener	Polyimide 3 mil thick	25
Total		197

* To prevent release of the FPC due to its bending, use of the double sided FPC with copper foil on the back side is not recommended.

3. Precautions

- 1 : This specification is a recommendation for the construction of the FH39 Series FPC (t=0.2±0.03).
- 2 : For details about the construction, please contact the FPC manufacturers.

◆ Packaging Specification

● Embossed Carrier Tape Dimensions (Tape width to 24mm max.)

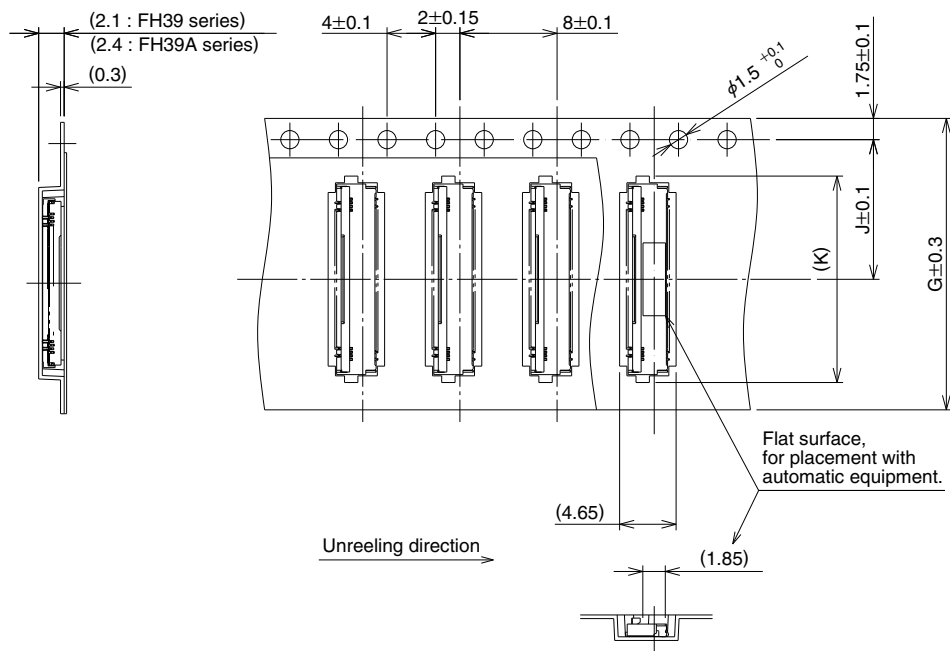

● Embossed Carrier Tape Dimensions (Tape width 32mm min.)

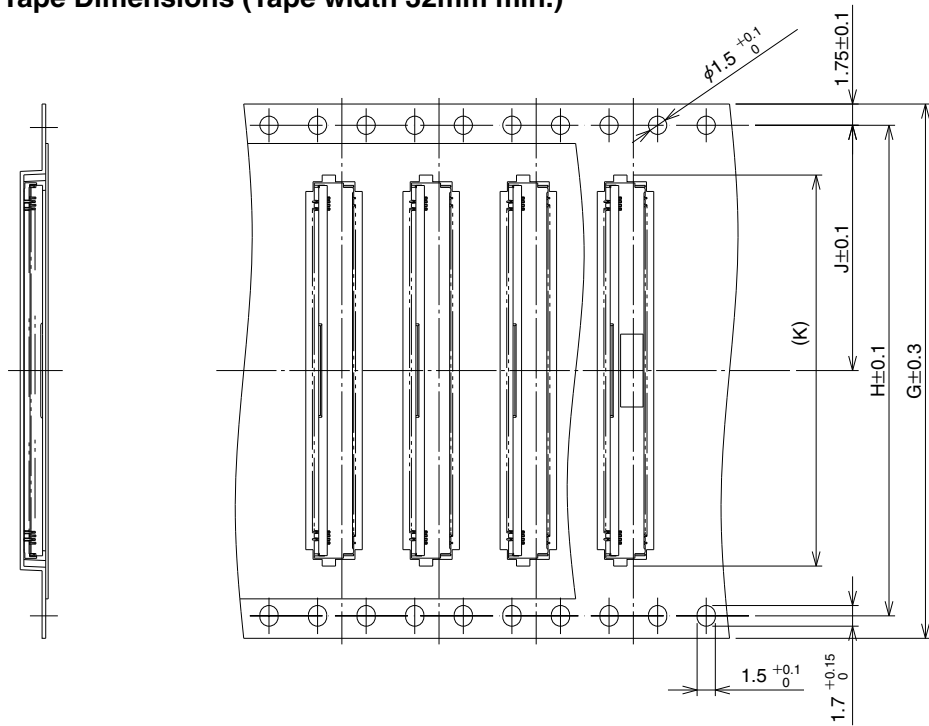

● Reel Dimensions

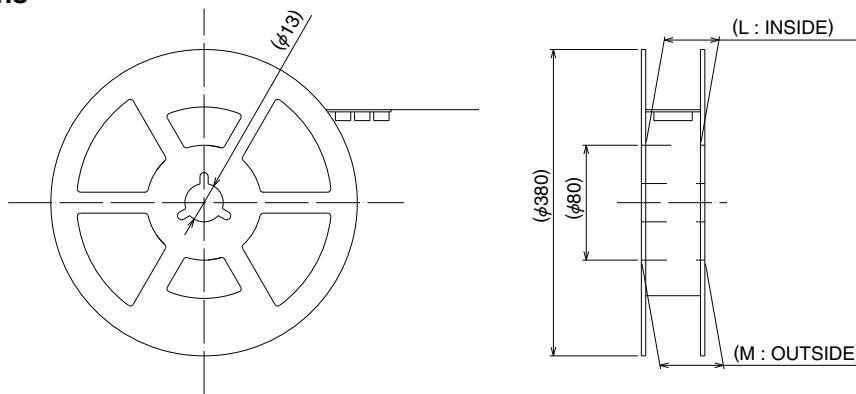

All dimensions : mm

Part No.	HRS No.	No. of Contacts	G	H	J	K	L	M
FH39-25S-0.3SHW(10)	580-1806-8 10	25	24	—	11.5	11	25.4	29.4
FH39-27S-0.3SHW(10)	580-1805-5 10	27		—		11.6		
FH39-29S-0.3SHW(10)	580-1807-0 10	29		—		12.2		
FH39-33S-0.3SHW(10)	580-1803-0 10	33		—		13.4		
FH39-39S-0.3SHW(10)	580-1800-1 10	39		—		15.2		
FH39-45S-0.3SHW(10)	580-1802-7 10	45	32	28.4	14.2	17	33.4	37.4
FH39-51S-0.3SHW(10)	580-1801-4 10	51	44	40.4	20.2	18.8	45.4	49.4
FH39-61S-0.3SHW(10)	580-1808-3 10	61				21.8		
FH39A-67S-0.3SHW(10)	580-1809-6 10	67				23.6		
FH39J-25S-0.3SHW(10)	580-1815-9 10	25	24	—	11.5	11	25.4	29.4
FH39J-33S-0.3SHW(10)	580-1814-6 10	33		—		13.4		
FH39J-39S-0.3SHW(10)	580-1813-3 10	39		—		15.2		
FH39J-45S-0.3SHW(10)	580-1811-8 10	45	32	28.4	14.2	17	33.4	37.4
FH39J-51S-0.3SHW(10)	580-1812-0 10	51				18.8		

◆ Connector Operation and Precautions

Operation

Exercise care when handling connectors. Follow recommendations given below.

1. As delivered

Delivered with the actuator open. There is no need to operate the actuator prior to the insertion of the FPC.

[Note]

- Do not close the actuator if the FPC has not been inserted yet.
- If the actuator is closed without the FPC, it can narrow the contact gap and increases the insertion force.

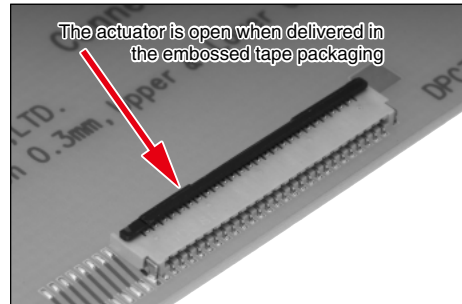

2. FPC insertion

Align the FPC perpendicular with the connector and insert it firmly all the way.

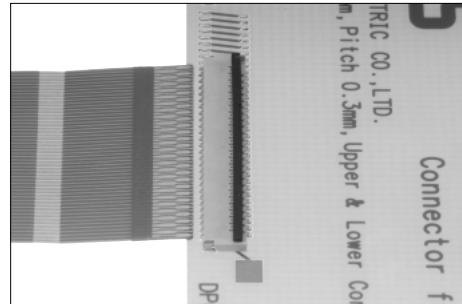

3. Locking method

- 1 Operate the actuator in a rotational manner and press it down.

Rotate and push down on the middle portion or the entire width of the actuator using the finger tip.

Be sure to distribute the pressure evenly across the actuator, pressing down on only one side of the actuator may damage the actuator. Excessive force on the housing can also lead to damage or malfunction.

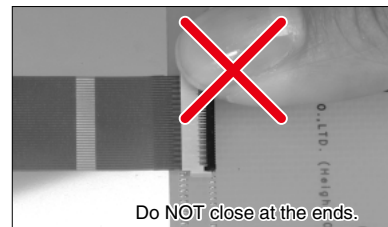
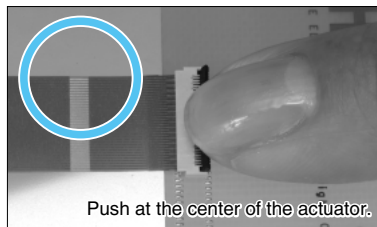
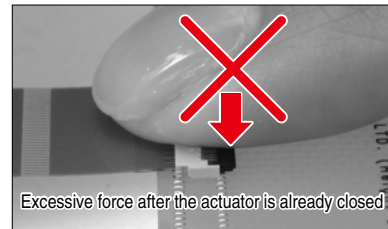
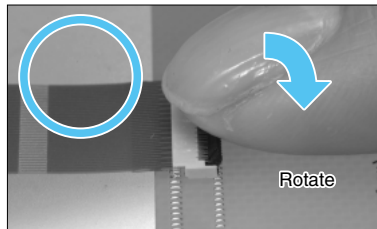

4. FPC removal (Lock release)

- 1 Slowly rotate the actuator in an upward motion. After it is unlocked, the FPC can be removed.

- 2 When unlocking the actuator, always touch the middle portion of the actuator.

Again, be sure to distribute the pressure evenly across the actuator, pressing down on only one side may damage the actuator. The actuator has a maximum opening of 90°. Trying to open it more than that or applying any unnecessary force to the actuator will cause damage and possibly failure of the connector.

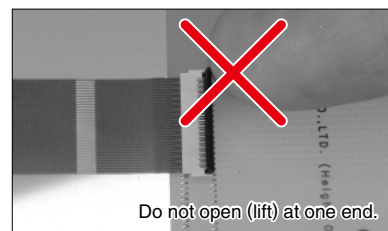
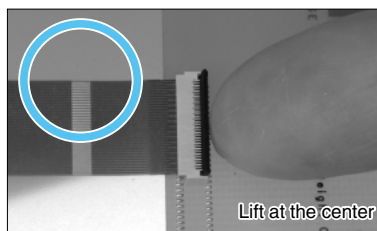
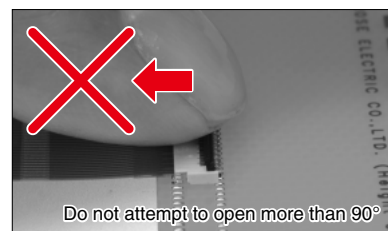
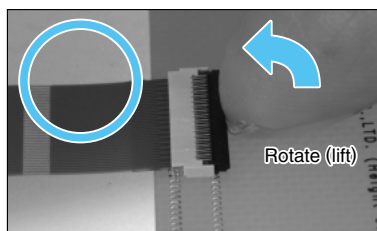

* The actuator opens by rotating it in the direction opposite to the direction of the insertion of the FPC. do not attempt to open it from the same side as the insertion of the FPC.

Precautions when mounting connectors on the PCB

◆PC board warpage

Minimize the warpage as much as possible. The connector is straight within 0.1 mm max. Make sure that the mounting area flatness can accept the connector terminals without causing any failure of the solder joints.

◆Handling before mounting on PCB

Do not apply 0.5N or more external force to the connector before mounting.
Insertion of the FPC or operation of the actuator prior to mounting on the PCB is not recommended.

◆Forces on the board

When braking the large PC board into individual boards exercise care not to damage the installed connectors.

When attaching the boards or other components with the screws make sure that any stresses will not cause board deflections affecting the mounting areas of the connector.

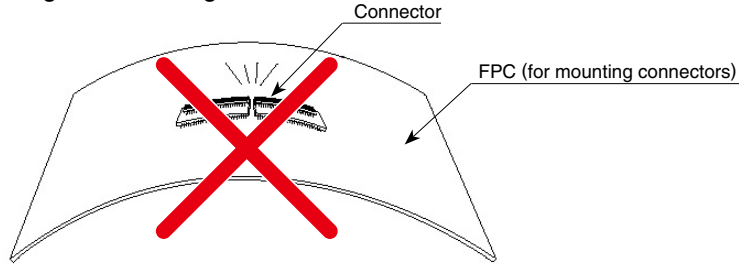

Other precautions

◆When hand soldering:

- Do not perform hand soldering with the FPC inserted in the connector.
 - Do not apply excessive heat or touch the soldering iron anywhere other than the connector leads.
 - Do not use excessive amount of solder or flux compounds.
- Operation of the actuator or contacts may be affected by excessive amounts of solder or flux compounds.

◆Temperature Profile

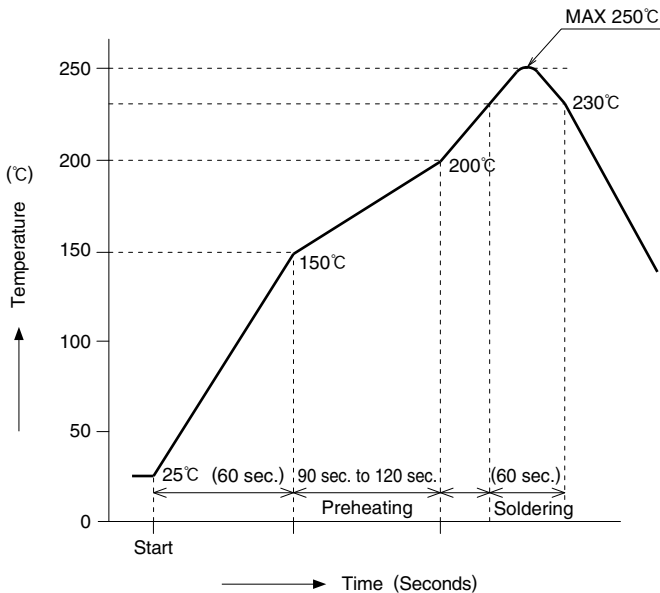

HRS test condition

- Solder method : Reflow, IR/hot air
- Environment : Room air
- Solder composition : Paste, 96.5%Sn/3.0%Ag/0.5%Cu (Senju Metal Industry, Co., Ltd.'s Part No.:M705-221CM5-32-10.5)
- Test board : Glass epoxy 25mm×50mm×0.8mm thick
- Land dimensions : 0.3mm×0.5mm, 0.3mm×0.67mm
- Metal mask : 0.25×0.42, 0.25×0.57×0.1mm thick

The temperature profiles shown are based on the above conditions.
In individual applications the actual temperature may vary, depending on solder paste type, volume / thickness and board size / thickness. Consult your solder paste and equipment manufacturer for specific recommendations.



HIROSE ELECTRIC CO.,LTD.

2-6-3,Nakagawa Chuoh,Tsuzuki-Ku,Yokohama-Shi 224-8540,JAPAN
TEL: +81-45-620-3526 Fax: +81-45-591-3726
<http://www.hirose.com>
<http://www.hirose-connectors.com>

X-ON Electronics

Largest Supplier of Electrical and Electronic Components

Click to view similar products for [FFC & FPC Connectors](#) category:

Click to view products by [Hirose](#) manufacturer:

Other Similar products are found below :

[K-FC20](#) [FH29B-80S-0.2SHW\(99\)](#) [FPH-2022G](#) [AYF332735](#) [52610-1075](#) [52610-1275](#) [52610-1934](#) [501864-3091-TR225](#) [086222026001800](#)
[52610-0675](#) [62684-36210E9ALF](#) [52746-1671-TR250](#) [10051922-2810EHLF](#) [6-520415-9](#) [SFV6R-1STE9HLF](#) [XF3M-2915-1B-R100](#)
[1658549-1](#) [46214008010800](#) [AYF534065TA](#) [AYF351525](#) [086212040340800+](#) [AYF530365TA](#) [67000-014LF](#) [67000-004LF](#)
[006207341915000+](#) [DS1020-19RT1D](#) [67000-003LF](#) [67000-011LF](#) [67000-016LF](#) [HFW14R-2STE9LF](#) [SFV32R-2STBE9HLF](#) [SFW12R-](#)
[5STE9LF](#) [SFW18R-1STAE9LF](#) [SFW4R-5STE9LF](#) [52807-0430](#) [046283021002868+](#) [THD1015-8CL-SN](#) [67000-006LF](#) [502250-8027](#)
[104267-9617](#) [66987-011LF](#) [AYF362535](#) [F0501-T-50-20T-R](#) [HFW8S-2STAE1HLF](#) [67000-008LF](#) [67000-012LF](#) [ECC576069EU](#) [F1002-B-](#)
[20-20T-R](#) [HFW15S-2STAE1HLF](#) [0781271110](#)