

GT13 Series

— Compact Coaxial Cable Connectors —

〈In-line type, Board type〉

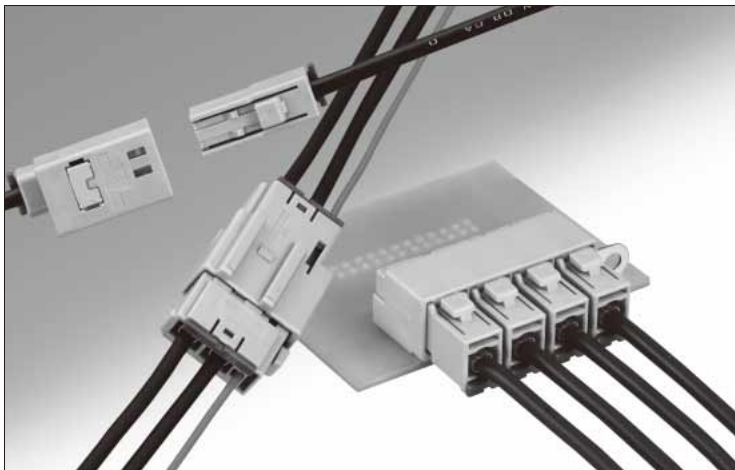

■ Features

- **Cost performance:**
Signal wires and shield wires can be crimped in one step.
- **Space-saving design**
Smaller than GT5 Series.

■ Applications

For car TV, radio antenna, etc.

Dec. 1, 2021. Copyright 2021 HIROSE ELECTRIC CO., LTD. All Rights Reserved.

F Terminal

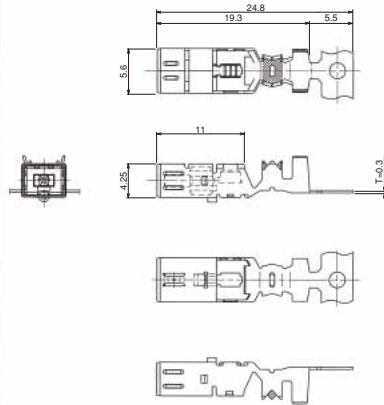

Part No.	HRS No.	Material / Finish or color	Conductor size	Insulator outer diameter	Jacket outer diameter	Sales unit	RoHS
GT13-2428/1.6-2.9SCF(55)	763-0001-3 55	Insulator : PBT/Dark gray Center terminal : Copper alloy /Tin plating Outer terminal : Copper alloy /Tin plating	AWG#24~28	φ1.5~2.0	φ2.7~3.4	3,000 pcs/reel	○
GT13-30/1.6-2.9SCF(55)	763-0012-0 55		AWG#30				
GT13-2428/F4-5SCF(55)	763-0051-1 55		AWG#24~28	φ3.0~3.6	φ4.6~5.0	2,200 pcs/reel	
GT13-30/F4-5SCF(55)	763-0067-1 55		AWG#30				

M Terminal

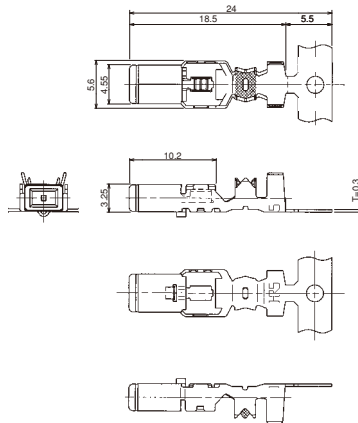

Part No.	HRS No.	Material / Finish or color	Conductor size	Insulator outer diameter	Jacket outer diameter	Sales unit	RoHS
GT13-2428/1.6-2.9PCF(70)	763-0002-6 70	Insulator : PBT/Dark gray Center terminal : Copper alloy /Tin plating Outer terminal : Copper alloy /Tin plating	AWG#24~28	φ1.5~2.0	φ2.7~3.4	4,000 pcs/reel	○
GT13-30/1.6-2.9PCF(70)	763-0041-8 70		AWG#30				
GT13-2428/F4-5PCF(70)	763-0054-0 70		AWG#24~28	φ3.0~3.6	φ4.6~5.0	2,200 pcs /reel	
GT13-30/F4-5PCF(70)	763-0066-9 70		AWG#30				

GT5
GT13
GT16
GT19
GT21
GT36
GT43
GT17
GT32
GT25
KM32
ZE05
ZG052
HM-200
ZG04W
T2072L
FX26
DF40
DF40GL
RH28K
FH2K
FH65
FH40
FH63
FH67

Dec.1.2021 Copyright 2021 HIROSE ELECTRIC CO., LTD. All Rights Reserved.

Low-insertion Force F Terminal

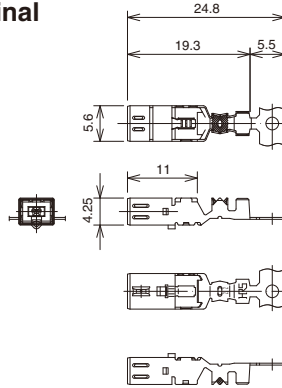

Part No.	HRS No.	Material / Finish or color	Conductor size	Insulator outer diameter	Jacket outer diameter	Sales unit	RoHS
GT13L-2428/1.1-2.2SCF(55)	763-0115-2 55	Insulator : PBT/Dark gray	AWG#24~28	φ1.0~1.4	φ2.0~2.4	3,000 pcs/reel	○
GT13L-2428/1.6-2.9SCF(55)	763-0132-0 55	Center terminal : Copper alloy /Tin plating		φ1.5~2.0	φ2.7~3.4		
GT13L-30/1.6-2.9SCF(55)	763-0098-0 55	Outer terminal : Copper alloy /Tin plating	AWG#30	φ1.5~2.0	φ2.7~3.4		

13S Series

F Housing (1 Coaxial)

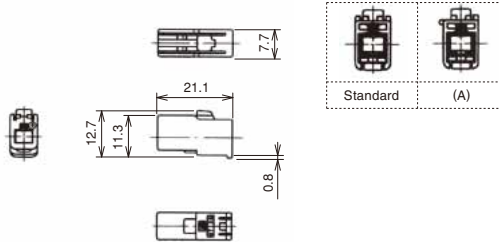

Retainer installed

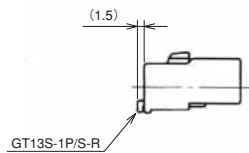

Part No.	HRS No.	Material	Color	Key position	Sales unit	RoHS
GT13S-1S-HU	763-0024-9	PBT	Light gray	Standard	1	○
GT13S-1S-HU(A)	763-0025-1		Brown	(A)		
GT13SN-1S-HU	763-0044-0		Black	Standard		

M Housing (1 Coaxial)

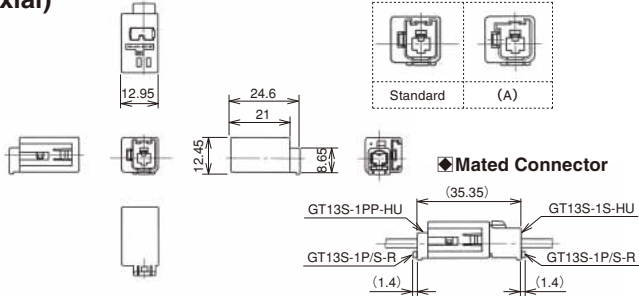

Part No.	HRS No.	Material / Finish	Color	Key position	Sales unit	RoHS
GT13S-1PP-HU	763-0030-1	Housing : PBT	Light gray	Standard	1	○
GT13S-1PP-HU(A)	763-0031-4	Ground terminal : Copper alloy/Tin plating	Brown	(A)		
GT13SN-1PP-HU	763-0006-0 00	Housing : PBT, bracket N type Ground terminal : None	Black	Standard		

Retainer

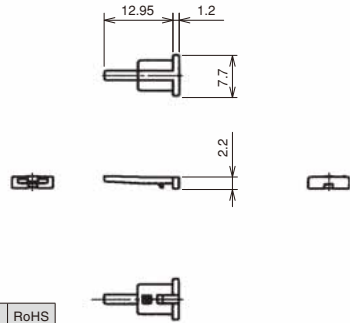

Part No.	HRS No.	Material	Color	Sales unit	RoHS
GT13S-1P/S-R	763-0033-0	PBT	Dark gray	1	○

F Housing (1 Coaxial) Retainer not required

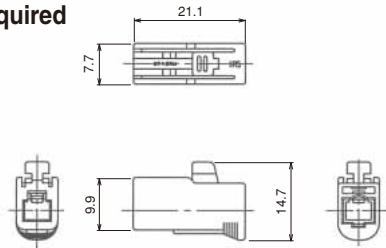

Part No.	HRS No.	Material	Color	Sales unit	RoHS
GT13RM-1S-HU	763-0099-8	PBT	Light gray	1	○



GT5
 GT13
 GT16
 GT19
 GT21
 GT36
 GT43
 GT17
 GT32
 GT25
 KM37
 ZE05
 ZG05/2
 HM-200
 ZG04W
 T20/23
 FX26
 DF40
 DF40GL
 RH28K
 FHS2K
 FHS5
 FH40
 FHS3
 FHS7

Board Mount type (1 Coaxial)

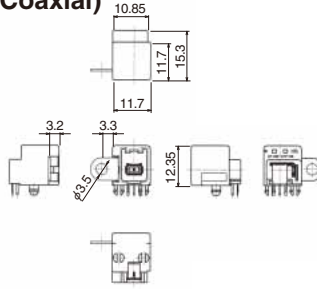

Recommended Board Dimensions

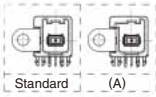
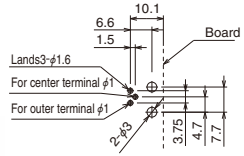

Mated Connector

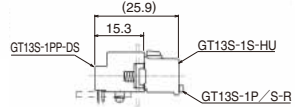

Recommended Panel Dimensions

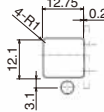

Part No.	HRS No.	Material / Finish	Color	Key position	Sales unit	RoHS
GT13S-1PP-DS	763-0027-7	Housing : PBT Center terminal : Copper alloy /Tin plating Outer terminal : Copper alloy /Tin plating Bracket hardware : Copper alloy / Tin plating	Light gray	Standard	1	○
GT13S-1PP-DS(A)	763-0028-0		Brown	(A)		

GT13SC Series

F Connector Power Supply Terminal

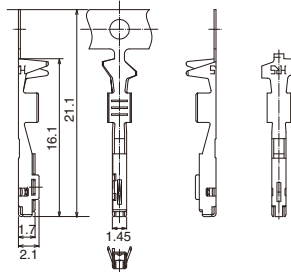
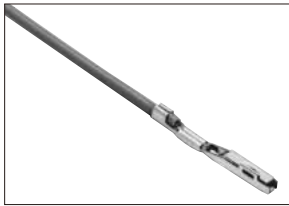

Part No.	HRS No.	Material	Finish	Conductor size	Insulator outer diameter	Sales unit	RoHS
GT10A-2022SCF	760-0014-6	Copper alloy	Tin plating	AWG#20~22	φ2.0 or less	8,000 pcs/reel	○

M Connector Power Supply Terminal

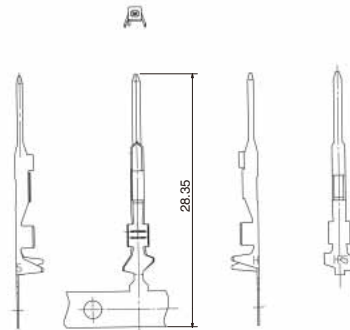
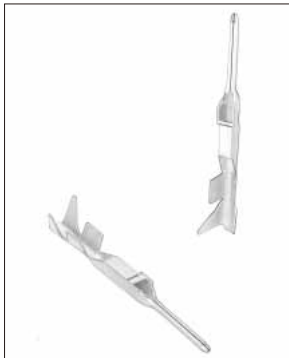

Part No.	HRS No.	Material	Finish	Conductor size	Insulator outer diameter	Sales unit	RoHS
GT10SC-2022PCF	760-0016-1	Copper alloy	Tin plating	AWG#20~22	φ1.5-2.0	7,000 pcs/reel	○
GT10A-2022PCF	760-0015-9				φ2.0 or less	10,000 pcs/reel	

Dec. 1, 2021. Copyright 2021 HIROSE ELECTRIC CO., LTD., All Rights Reserved.

■ F Housing (1 Coaxial + 1 Power)

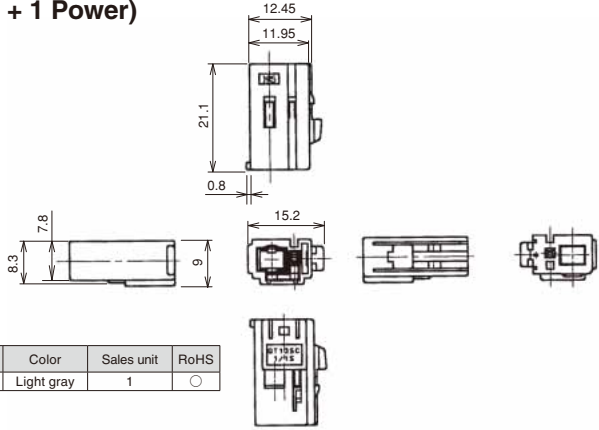
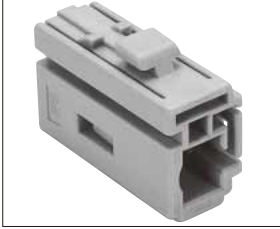

Part No.	HRS No.	Material	Color	Sales unit	RoHS
GT13SC-1/1S-HU	763-0010-4	PBT	Light gray	1	○

*GT10A-2022SCF is the power supply terminal.

● Retainer (Used with : GT13SC-1/1S-HU, GT13SS-1/1S-HU)

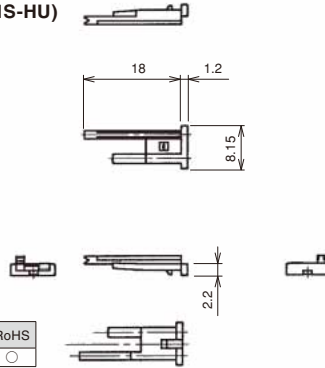

Part No.	HRS No.	Material	Color	Sales unit	RoHS
GT13SC-1/1S-R	763-0011-7	PBT	Dark gray	1	○

■ F Housing (1 Coaxial + 1 Power)

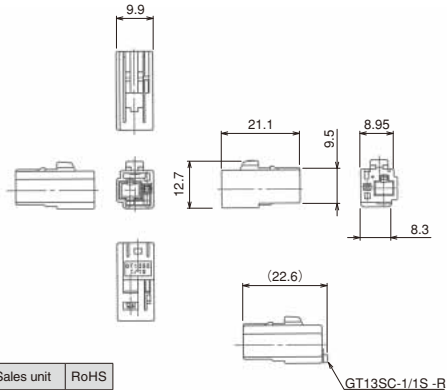

Part No.	HRS No.	Material	Color	Sales unit	RoHS
GT13SS-1/1S-HU	763-0093-1	PBT	Light gray	1	○

*GT10A-2022SCF is the power supply terminal.

◆ Retainer installed

GT5
GT13
GT16
GT19
GT21
GT36
GT43
GT17
GT32
GT25
KM37
ZE05
ZG052
HM-200
ZG04W
FD3731
FX26
DF40
DF40GL
RH28K
FH2K
FH5
FH40
FH63
FH67

Dec.1.2021 Copyright 2021 HIROSE ELECTRIC CO., LTD. All Rights Reserved.

■ F Housing (2 Coaxial)

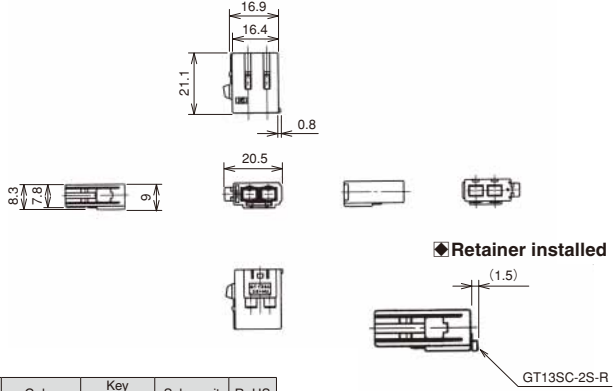

Part No.	HRS No.	Material	Color	Key position	Sales unit	RoHS
GT13SC-2S-HU	763-0014-5	PBT	Light gray	Standard	1	○

● Retainer (Used with : GT13SC-2S-HU, GT13SCN-2PP-HU, GT13SCH-2PP-HU)

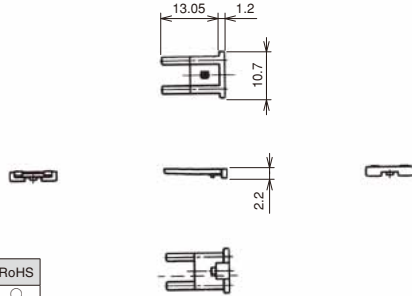

Part No.	HRS No.	Material	Color	Sales unit	RoHS
GT13SC-2S-R	763-0015-8	PBT	Dark gray	1	○

■ F Housing (2 Coaxial + 1 Power)

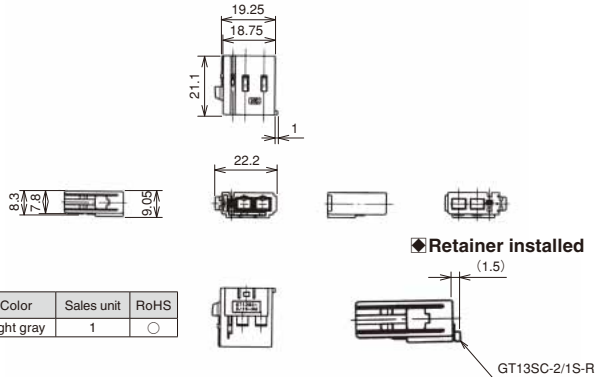

Part No.	HRS No.	Material	Color	Sales unit	RoHS
GT13SC-2/1S-HU	763-0016-0	PBT	Light gray	1	○

*GT10A-2022SCF is the power supply terminal.

Dec. 1, 2021. Copyright 2021 HIROSE ELECTRIC CO., LTD., All Rights Reserved. GT13 GT16 GT19 FH65 FH40 FH35 FH67

● Retainer (for GT13SC-2/1-HU only)

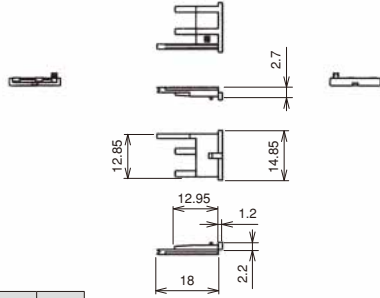

Part No.	HRS No.	Material	Color	Sales unit	RoHS
GT13SC-2/1S-R	763-0017-3	PBT	Dark gray	1	○

■ F Housing (4 Coaxial + 1 Power)

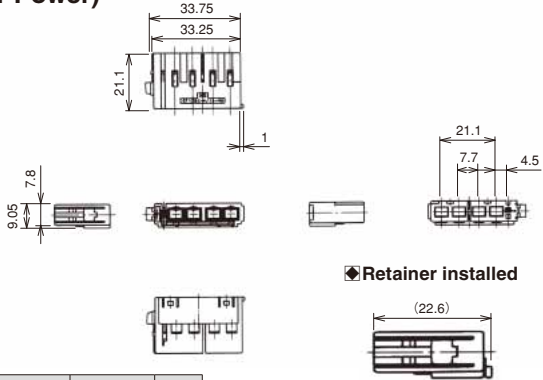

◆ Retainer installed

Part No.	HRS No.	Material	Color	Sales unit	RoHS
GT13SC-4/1S-HU	763-0021-0	PBT	Light gray	1	○
GT13SC-4/1S-HU(A)	763-0022-3		Brown		

*GT10A-2022SCF is the power supply terminal.

● Retainer (for GT13SC-4/1S-HU only)

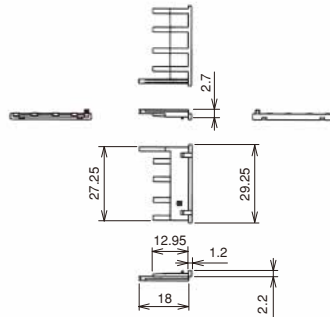
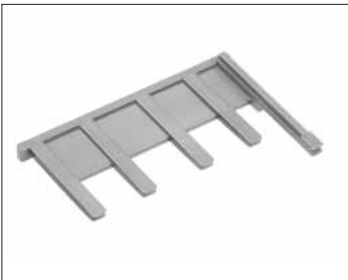

Part No.	HRS No.	Material	Color	Sales unit	RoHS
GT13SC-4/1S-R	763-0023-6	PBT	Dark gray	1	○

GT5
GT13
GT16
GT19
GT21
GT36
GT43
GT17
GT32
GT25
KM32
ZE05
ZG05/2
HM-200
ZG04W
T20/23
FX26
DF40
DF40GL
RH28K
FH2K
FH65
FH40
FH63
FH67

Dec.1.2021 Copyright 2021 HIROSE ELECTRIC CO., LTD. All Rights Reserved.

■ M Housing (1 Coaxial + 1 Power)

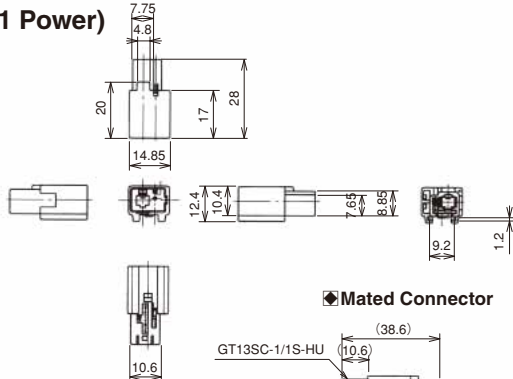

Part No.	HRS No.	Material	Color	Sales unit	RoHS
GT13SCN-1/1P-HU	763-0036-8	PBT	Light gray	1	○

*GT10SC-2022PCF or GT10A-2022PCF is the power supply terminal.

● Retainer

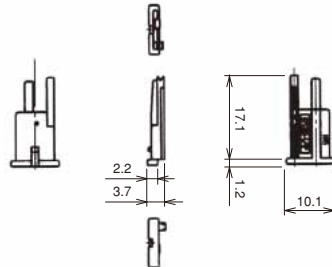

Part No.	HRS No.	Material	Color	Sales unit	RoHS
GT13SC-1/1P-R	763-0039-6	PBT	Dark gray	1	○

■ M Housing (1 Coaxial + 1 Power)

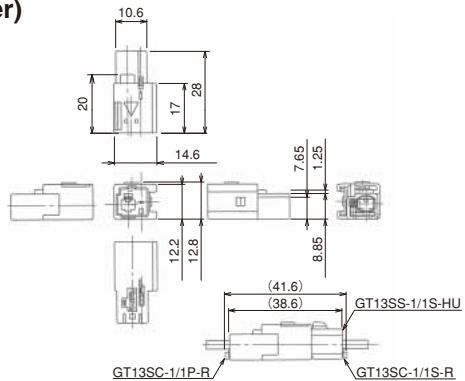

Part No.	HRS No.	Material	Color	Sales unit	RoHS
GT13SSN-1/1P-HU	763-0092-9	PBT	Light gray	1	○

*GT10SC-2022PCF or GT10A-2022PCF is the power supply terminal.

◆ Mated Connector

Dec. 1, 2021. Copyright 2021 HIROSE ELECTRIC CO., LTD., All Rights Reserved.

■ M Housing (2 Coaxial)

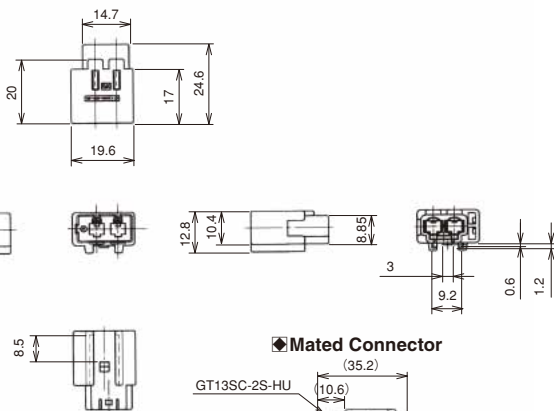
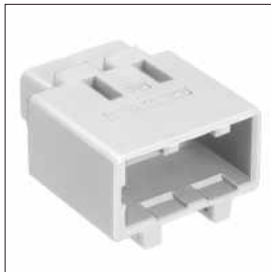

Part No.	HRS No.	Material	Color	Sales unit	RoHS
GT13SCN-2PP-HU	763-0046-1	PBT	Light gray	1	○

■ M Housing (2 Coaxial)

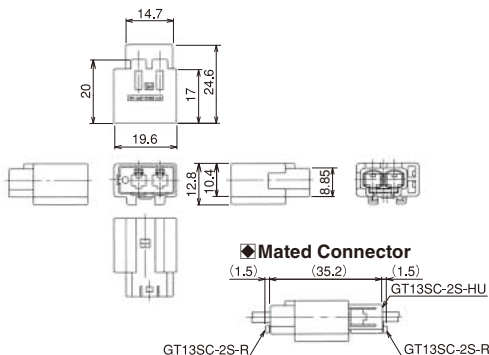

Part No.	HRS No.	Material	Color	Sales unit	RoHS
GT13SCH-2PP-HU	763-0072-1	PBT	Light gray	1	○

■ M Housing (2 Coaxial + 1 Power)

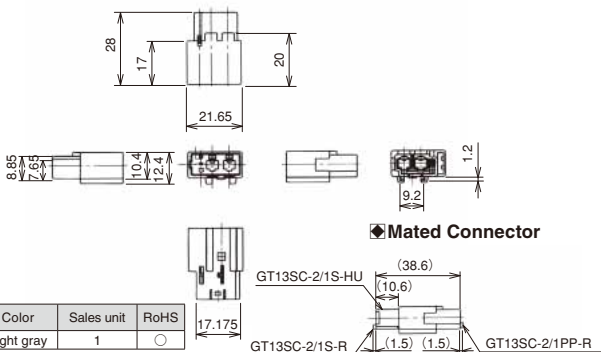

Part No.	HRS No.	Material	Color	Sales unit	RoHS
GT13SCN-2/1PP-HU	763-0038-3	PBT	Light gray	1	○

*GT10SC-2022PCF or GT10A-2022PCF is the power supply terminal.

GT5
GT13
GT16
GT19
GT21
GT36
GT43
GT17
GT32
GT25
KM32
ZE05
ZG052
HM-200
ZE64W
T2023
FX26
DF40
DF40GL
RH28K
FH32K
FH65
FH40
FH33
FH67

Dec.1.2021 Copyright 2021 HIROSE ELECTRIC CO., LTD. All Rights Reserved.

● Retainer (for GT13SCN-2/1PP-HU only)

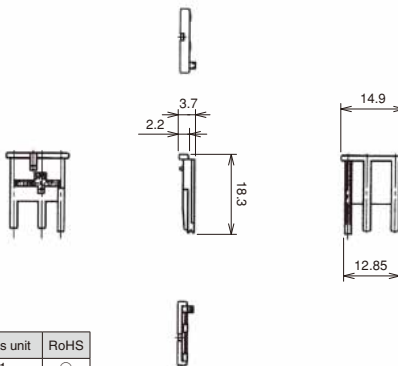
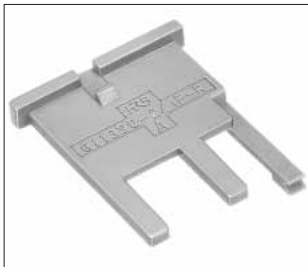

Part No.	HRS No.	Material	Color	Sales unit	RoHS
GT13SC-2/1PP-R	763-0040-5	PBT	Dark gray	1	○

■ M Housing (4 Coaxial + 1 Power)

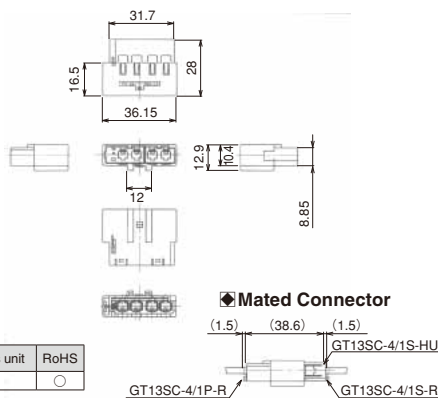

Part No.	HRS No.	Material	Color	Sales unit	RoHS
GT13SCH-4/1PP-HU	763-0060-2	PBT	Light gray	1	○

*GT10SC-2022PCF or GT10A-2022PCF is the power supply terminal.

● Retainer

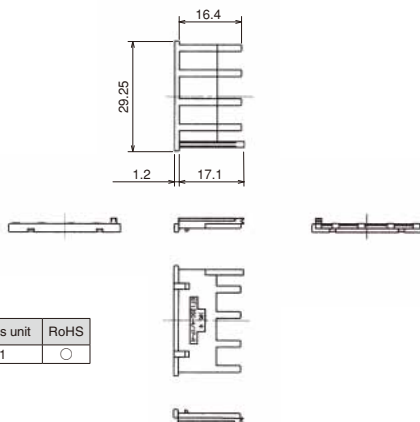

Part No.	HRS No.	Material	Color	Sales unit	RoHS
GT13SC-4/1P-R	763-0061-5	PBT	Dark gray	1	○

Dec. 1, 2021. Copyright 2021 HIROSE ELECTRIC CO., LTD., All Rights Reserved. GT13 GT16 GT19 FH65 FH40 FH35 FH67

■ Board Mount type (1 Coaxial + 1 Power)

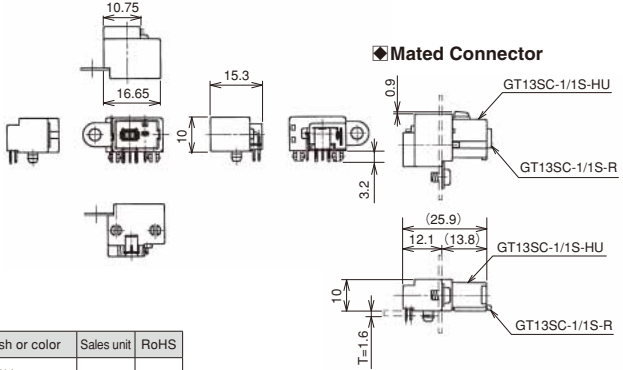

Part No.	HRS No.	Material / Finish or color	Sales unit	RoHS
GT13SC-1/1PP-DS(70)	763-0009-5 70	Housing : PBT / Light gray Center terminal : Copper alloy / Tin plating Outer terminal : Copper alloy / Tin plating Power terminal : Copper alloy / Tin plating Bracket hardware : Copper alloy / Tin plating	1	○

◆ Recommended Board Dimensions

◆ Recommended Panel Dimensions

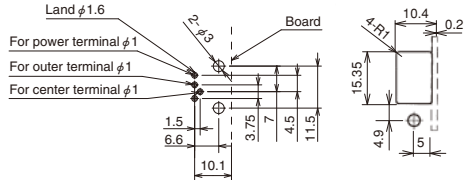

■ Board Mount type (2 Coaxial)

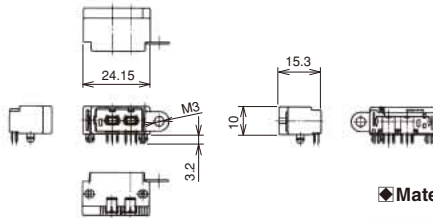

◆ Mated Connector

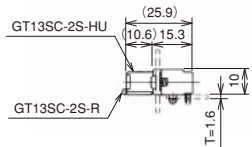

Part No.	HRS No.	Material	Color	Key position	Sales unit	RoHS
GT13SC-2/2S-DS(71)	763-0013-2 71	Housing : PBT Center terminal : Copper alloy / Tin plating Outer terminal : Copper alloy / Tin plating Bracket hardware : Copper alloy / Tin plating	Light gray	Standard	1	○

◆ Recommended Board Dimensions

◆ Recommended Panel Dimensions

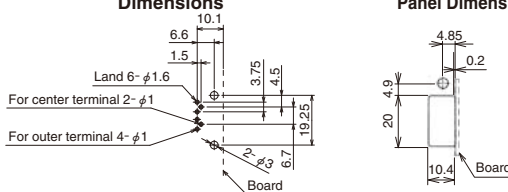

GT5
 GT13
 GT16
 GT19
 GT21
 GT36
 GT43
 GT17
 GT32
 GT25
 KM37
 ZS05
 ZS05J2
 WH-200
 ZS04W
 IT202K
 FK26
 DF40
 DF40GL
 FH28K
 FH2K
 FH5
 FH40
 FH63
 FH67

■ Board Mount type (2 Coaxial + 1 Power)



◆ Recommended Board Dimensions

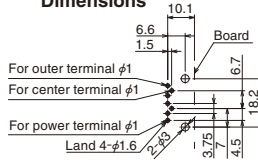

◆ Recommended Panel Dimensions

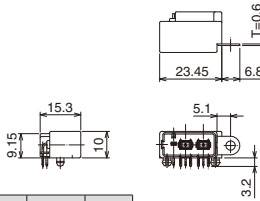
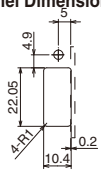

◆ Mated Connector

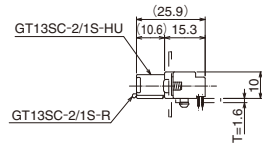

Part No.	HRS No.	Material / Finish or color	Sales unit	RoHS
GT13SC-2/1PP-DS(70)	763-0018-6 70	Housing : PBT Light gray Center terminal : Copper alloy / Tin plating Outer terminal : Copper alloy / Tin plating Power terminal : Copper alloy / Tin plating Bracket hardware : Copper alloy / Tin plating	1	○

■ Board Mount type (4 Coaxial + 1 Power)

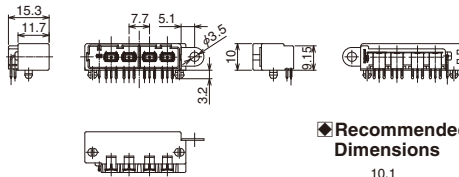
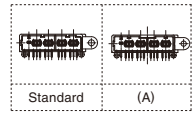
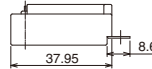
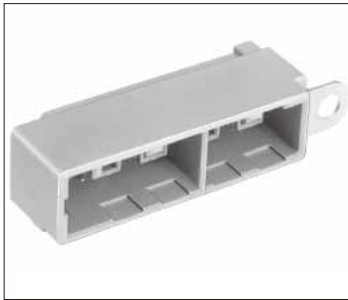

◆ Recommended Board Dimensions

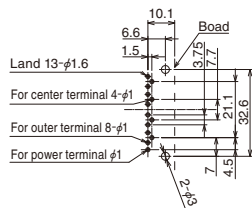

Part No.	HRS No.	Material	Color	Key position	Sales unit	RoHS
GT13SC-4/1PP-DS(70)	763-0019-9 70	Housing : PBT Center terminal : Copper alloy / Tin plating Outer terminal : Copper alloy / Tin plating Power terminal : Copper alloy / Tin plating Bracket hardware : Copper alloy / Tin plating	Light gray	Standard	1	○
GT13SC-4/1PP-DS(A)(70)	763-0020-8 70		Brown	(A)		

◆ Mated Connector

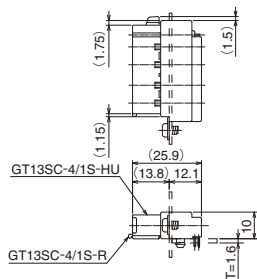

◆ Recommended Panel Dimensions

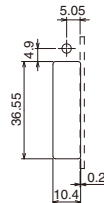

GT13SH Series

Power Supply Terminals

F Connector Terminals

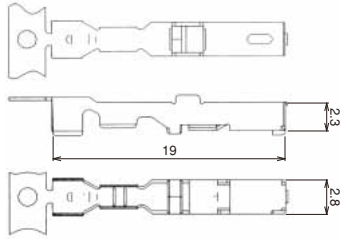

Part No.	HRS No.	Material	Finish	Conductor size	Jacket outer diameter	Sales unit	RoHS
GT7-2022SCF(70)	757-0001-1 70	Copper alloy	Tin plating	AWG#20~22	φ1.4~2.4	5,000 pcs/reel	○
GT7A-2022SCF(70)	757-0003-7 70				φ2.6~3.1		

Note 1 : This product is sold in units of reels. (See the table above for number of pcs per reel.)
 Note 2 : This product cannot be used with housings from other manufacturers.

M Connector Terminals

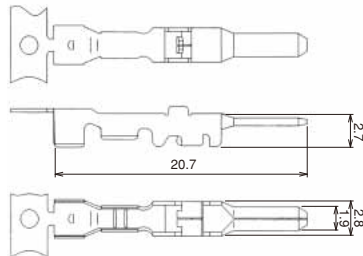

Part No.	HRS No.	Material	Finish	Conductor size	Jacket outer diameter	Sales unit	RoHS
GT7-2022PCF(70)	757-0002-4 70	Brass	Tin plating	AWG#20~22	φ1.4~2.4	5,000 pcs/reel	○
GT7A-2022PCF(70)	757-0004-0 70				φ2.6~3.1		

Note 1 : This product is sold in units of reels. (See the table above for number of pcs per reel.)
 Note 2 : This product cannot be used with housings from other manufacturers.

F Housing (1 Coaxial + 1 Power)

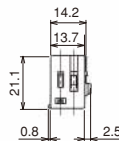

Part No.	HRS No.	Material	Color	Sales unit	RoHS
GT13SH-1/1S-HU	763-0048-7	PBT	Light gray	1	○
GT13SH-1/1S-HU(A)	763-0059-3		Brown		



*GT7-2022SCF (70) or GT7A-2022SCF (70) is the power supply terminal.

Dec. 1, 2021. Copyright 2021 HIROSE ELECTRIC CO., LTD. All Rights Reserved. GT5 GT13 GT16 GT19 FH65 FH40 FH35 FH67

● Retainer

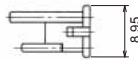
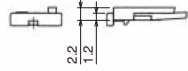
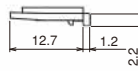

Part No.	HRS No.	Material	Color	Sales unit	RoHS
GT13SH-1/1S-R	763-0049-0	PBT	Dark gray	1	○

■ F Housing (2 Coaxial + 1 Power)

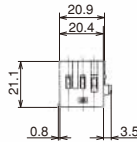

Part No.	HRS No.	Material	Color	Sales unit	RoHS
GT13SH-2/1S-HU	763-0065-6	PBT	Light gray	1	○
GT13SHB-2/1S-HU	763-0131-0				

*GT7-2022SCF (70) or GT7A-2022SCF (70) is the power supply terminal.

● Retainer

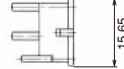
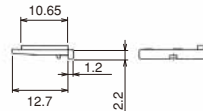
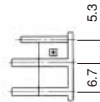

Part No.	HRS No.	Material	Color	Sales unit	RoHS
GT13SH-2/1S-R	763-0064-3	PBT	Dark gray	1	○

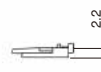

Dec. 1, 2021. Copyright 2021 HIROSE ELECTRIC CO., LTD., All Rights Reserved.

■ M Housing (1 Coaxial + 1 Power)

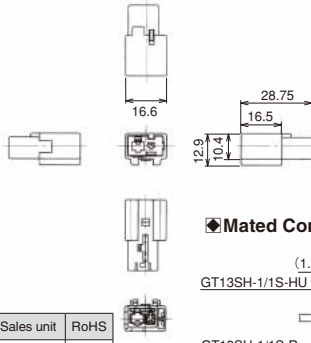

Part No.	HRS No.	Material	Color	Sales unit	RoHS
GT13SH-1/1P-HU	763-0055-2	PBT	Light gray	1	○

*GT7-2022SPCF (70) or GT7A-2022PCF (70) is the power supply terminal.

◆ Mated Connector

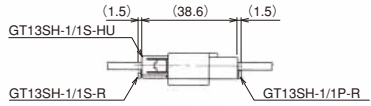

■ M Housing (1 Coaxial + 1 power)

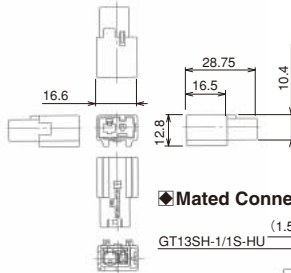

Part No.	HRS No.	Material	Color	Sales unit	RoHS
GT13SHN-1/1PP-HU	763-0078-8	PBT	Light gray	1	○

*GT7-2022SPCF (70) or GT7A-2022PCF (70) is the power supply terminal.

◆ Mated Connector

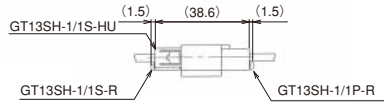

● Retainer

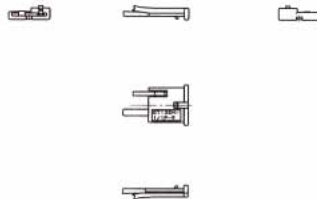
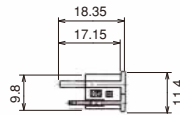

Part No.	HRS No.	Material	Color	Sales unit	RoHS
GT13SH-1/1P-R	763-0056-5	PBT	Dark gray	1	○

■ M Housing (2 Coaxial + 1 Power)

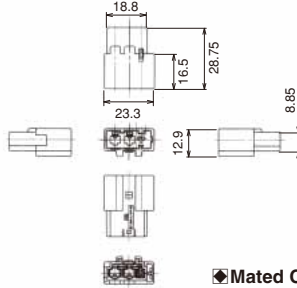

Part No.	HRS No.	Material	Color	Sales unit	RoHS
GT13SH-2/1PP-HU	763-0076-2	PBT	Light gray	1	○

*GT7-2022PCF (70) or GT7A-2022PCF (70) is the power supply terminal.

◆ Mated Connector

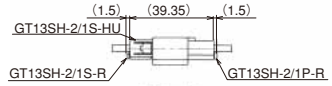

● Retainer

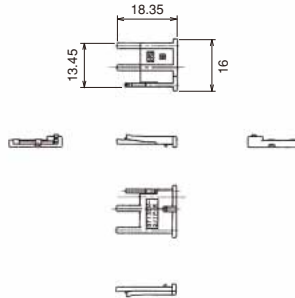

Part No.	HRS No.	Material	Color	Sales unit	RoHS
GT13SH-2/1P-R	763-0077-5	PBT	Dark gray	1	○

■ Board Mount type (1 Coaxial)

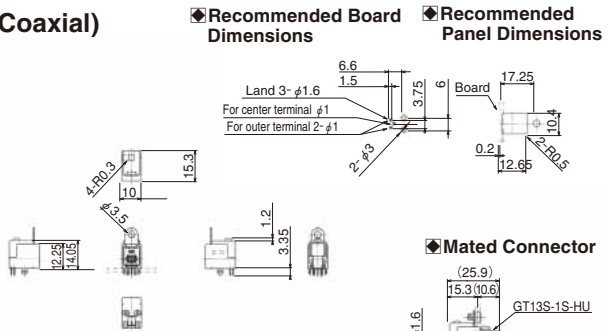

Part No.	HRS No.	Material / Finish or color	Sales unit	RoHS
GT13SHA-1PP-DS	763-0062-8	Housing : PBT/ Light gray Center terminal : Copper alloy / Tin plating Outer terminal : Copper alloy / Tin plating Bracket hardware : Copper alloy / Tin plating	1	○

GT13 GT16 GT19 HIROSE ELECTRIC CO., LTD., All Rights Reserved. FH65 FH40 FH35 FH67

Board Mount type (1 Coaxial + 1 Power)



Recommended Board Dimensions

Recommended Panel Dimensions

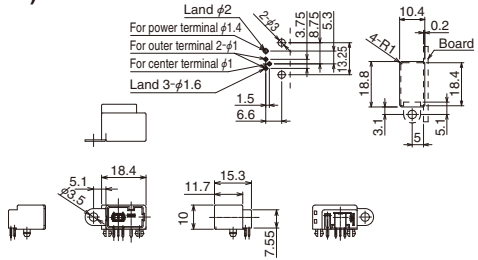

Part No.	HRS No.	Material / Finish or color	Sales unit	RoHS
GT13SH-1/1PP-DS	763-0050-9	Housing : PBT / Light gray Center terminal : Copper alloy / Tin plating Outer terminal : Copper alloy / Tin plating Power terminal : Copper alloy / Tin plating Bracket hardware : Copper alloy / Tin plating	1	○

Mated Connector

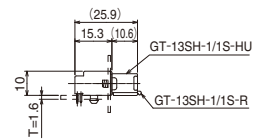

Board Mount type (1 Coaxial + 1 Power)



Recommended Board Dimensions

Recommended Panel Dimensions

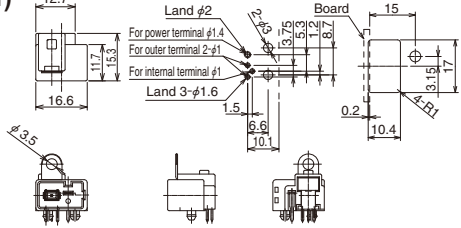

Part No.	HRS No.	Material / Finish	Color	Sales unit	RoHS
GT13SHA-1/1PP-DS	763-0057-8	Housing : PBT Center terminal : Copper alloy / Tin plating Outer terminal : Copper alloy / Tin plating Power terminal : Copper alloy / Tin plating Bracket hardware : Copper alloy / Tin plating	Light gray	1	○

Mated Connector

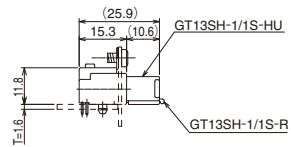

Board Mount type (1 Coaxial + 1 Power)



Recommended Board Dimensions

Recommended Panel Dimensions

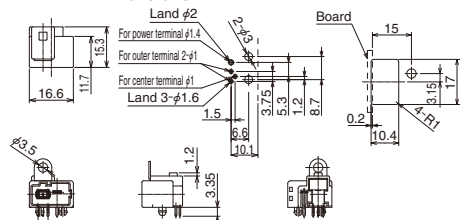

Part No.	HRS No.	Material / Finish	Color	Sales unit	RoHS
GT13SHA-1/1PP-DS(A)	763-0058-0	Housing : PBT Center terminal : Copper alloy / Tin plating Outer terminal : Copper alloy / Tin plating Power terminal : Copper alloy / Tin plating Bracket hardware : Copper alloy / Tin plating	Brown	1	○

Mated Connector

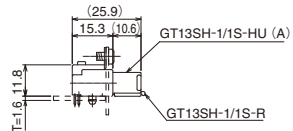

Board Mount type (2 Coaxial + 1 Power)



Recommended Board Dimensions

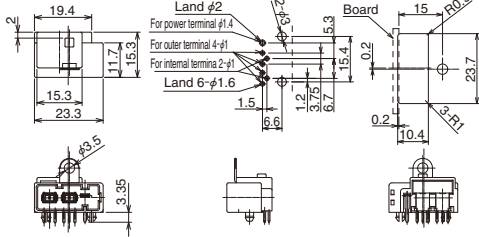

Mated Connector

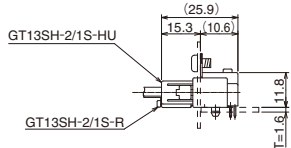

Part No.	HRS No.	Material / Finish or color	Sales unit	RoHS
GT13SHA-2/1PP-DS	763-0063-0	Housing : PB7 Light gray Center terminal : Copper alloy (Tin plating) Outer terminal : Copper alloy (Tin plating) Power terminal : Copper alloy (Tin plating) Bracket hardware : Copper alloy / Tin plating	1	○
GT13SHB-2/1P-DS	763-0125-0			

Crimping Tools

Please ask your Hirose Electric account representative for a user manual.

Automatic Crimping Machine



Photo for reference only.
Subject to change.

Part No. CM-105C

Specifications

Item	Specifications	Remarks
Press capacity	1.5tons	
Stroke length	30mm	
Number of strokes	200spm (50Hz)	200spm (60Hz)
Weight	75kg	
Motor	0.2kW	AC100V
Crimping speed	2,000-4,000/H	

*Terminal crimp height setting tables are available for each cable type. Please contact your Hirose Electric account representative.

Please note that we will need to define new crimp heights for novel cables and this may take a few days.

*Requires special reel stand.

Harness Tools

HRS No.	Applicable Terminal	Part No.	HRS No.
763-0001-3-55	GT13-2428/1.6-2.9SCF(55)	AP105-GT13-2428/1.6-2.9S	901-5073-1
763-0002-6-70	GT13-2428/1.6-2.9PCF(70)	AP105-GT13-2428/1.6-2.9P	901-5074-7
763-0012-0-55	GT13-30/1.6-2.9SCF(55)	AP105-GT13-30/1.6-2.9S-ID	901-5099-5
763-0041-8-70	GT13-30/1.6-2.9PCF(70)	AP105-GT13-30/1.6-2.9P-ID	901-5118-8
763-0012-0-55	GT13-30/1.6-2.9SCF(55)	AP105-GT13-30/1.6-2.9S	901-5116-2
763-0041-8-70	GT13-30/1.6-2.9PCF(70)	AP105-GT13-30/1.6-2.9P	901-5119-0

Please refer to our cable termination procedure manual for performing terminations.

X-ON Electronics

Largest Supplier of Electrical and Electronic Components

Click to view similar products for [Automotive Connectors](#) category:

Click to view products by [Hirose](#) manufacturer:

Other Similar products are found below :

[003-018-000](#) [60403001](#) [60993906-B](#) [M902-2131](#) [M902-2161](#) [72.330.1035.1](#) [73.353.4028.0](#) [F119300-B](#) [F166900](#) [F258300-B](#) [F358300-B](#)
[F407400](#) [F444110](#) [F487000](#) [F509500B-B](#) [827153-1](#) [8N1515-32-24P](#) [9-1326729-8](#) [925474-1](#) [928905-1](#) [964562-4](#) [968782-1](#) [GT17SA-8DS-](#)
[HU](#) [98891-1012](#) [98947-1016](#) [12004147](#) [12004475-L](#) [12010290](#) [12010309-B](#) [12015454](#) [12020219-B](#) [12020308](#) [12041318-B](#) [12052225-L](#)
[12052466](#) [12059125](#) [12064869](#) [12004327-B](#) [12010503-B](#) [12015308](#) [12015384](#) [12015909](#) [1-21030-1](#) [12041254](#) [12041318](#) [12047946-B](#)
[12047957](#) [12047957-L](#) [12059473](#) [12066261](#)