

Jun.1.2019 Copyright 2019 HIROSE ELECTRIC CO., LTD. All Rights Reserved.
In case of consideration for using Automotive equipment / device which demand high reliability, kindly contact our sales window correspondents.

ELV, RoHS COMPLIANT

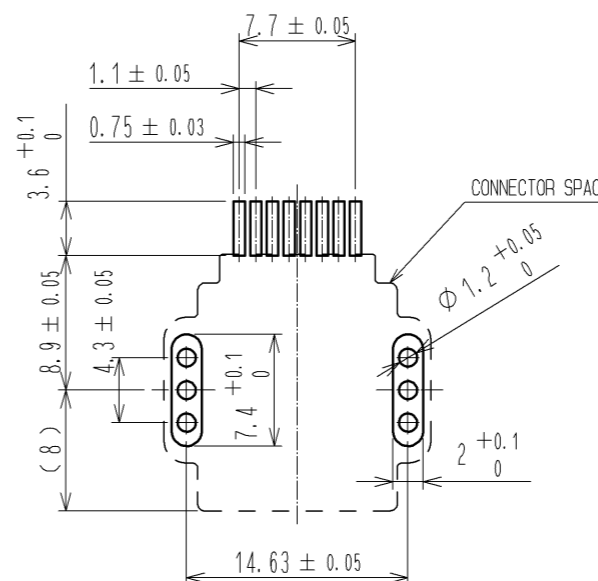

RECOMMENDED PC BOARD PATTERN

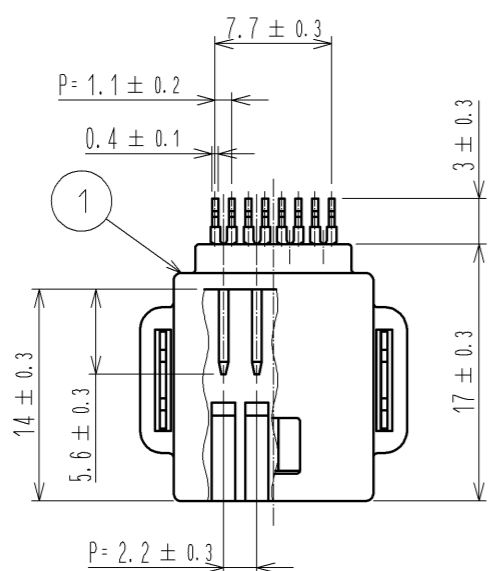
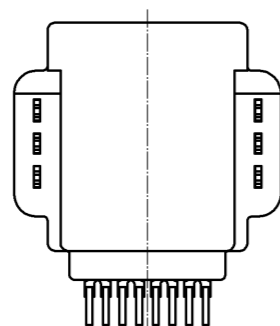
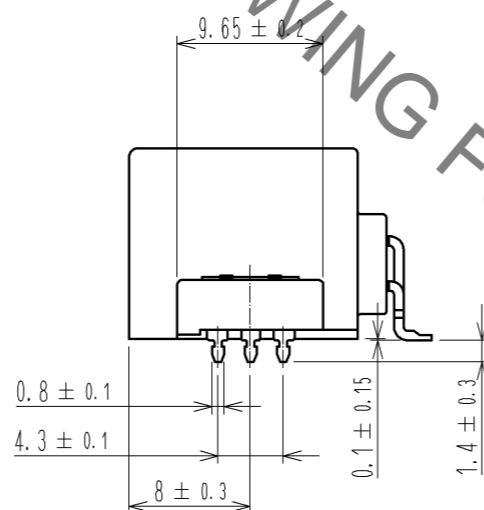
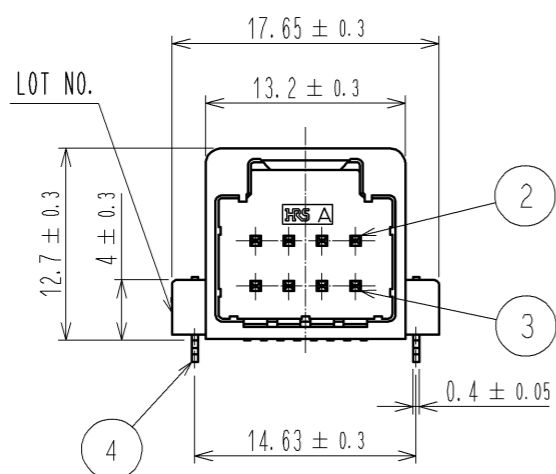

- NOTE 1. RECOMMENDED TEMPERATURE PROFILE FOR REFLOW (REFER TO RIGHT FIG.)
USED REFLOW SYSTEM : IR IN THE AIR OR NITROGEN
NO. OF CYCLES : 2 MAX
PEAK : 250°C
OVER 230°C : 20~40s
PREHEAT : 150~180°C
60~120s
2. TEMPERATURE FOR SOLDERING IRON : 280~300°C WITHIN 2s
3. CO-PLANARITY SHALL BE 0.1 MAX.
4. PC BOARD THICKNESS=1.6.
5. RECOMMENDED SOLDER THICKNESS=0.15

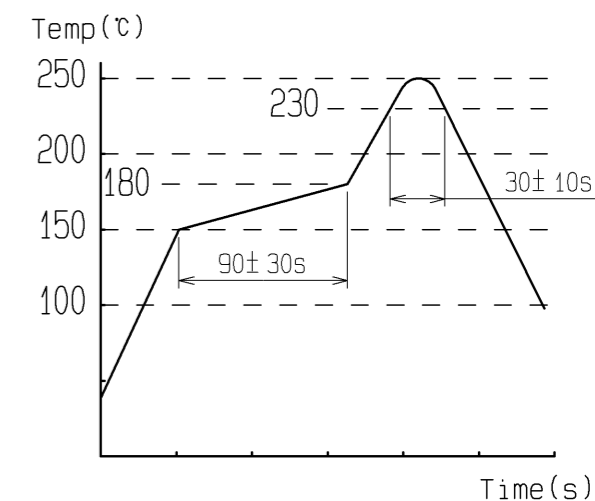

2	BRASS	TIN PLATED T=0.64	4	BRASS	TIN PLATED T=0.4		
1	PPS	LIGHT GRAY	3	BRASS	TIN PLATED T=0.64		
NO.	MATERIAL	FINISH . REMARKS	NO.	MATERIAL	FINISH . REMARKS		
UNITS mm		SCALE 2 : 1	COUNT △	DESCRIPTION OF REVISIONS	DESIGNED	CHECKED	DATE
HRS HIROSE ELECTRIC CO., LTD.		APPROVED : NH. NAKATA	14. 01. 09	DRAWING NO. EDC3-166406-05			
		CHECED : TY. TAKAHASHI	14. 01. 09	PART NO. GT25-8DP-2. 2H(32)			
		DESIGNED : TY. SAKASHITA	14. 01. 08	CODE NO. CL775-0004-1-32			
		DRAWN : TY. SAKASHITA	14. 01. 08			△ 1/1	

Jun.1.2019 Copyright 2019 HIROSE ELECTRIC CO., LTD. All Rights Reserved.
 In case of consideration for using Automotive equipment / device which demand high reliability, kindly contact our sales window correspondents.

PACKAGING SPECIFICATION

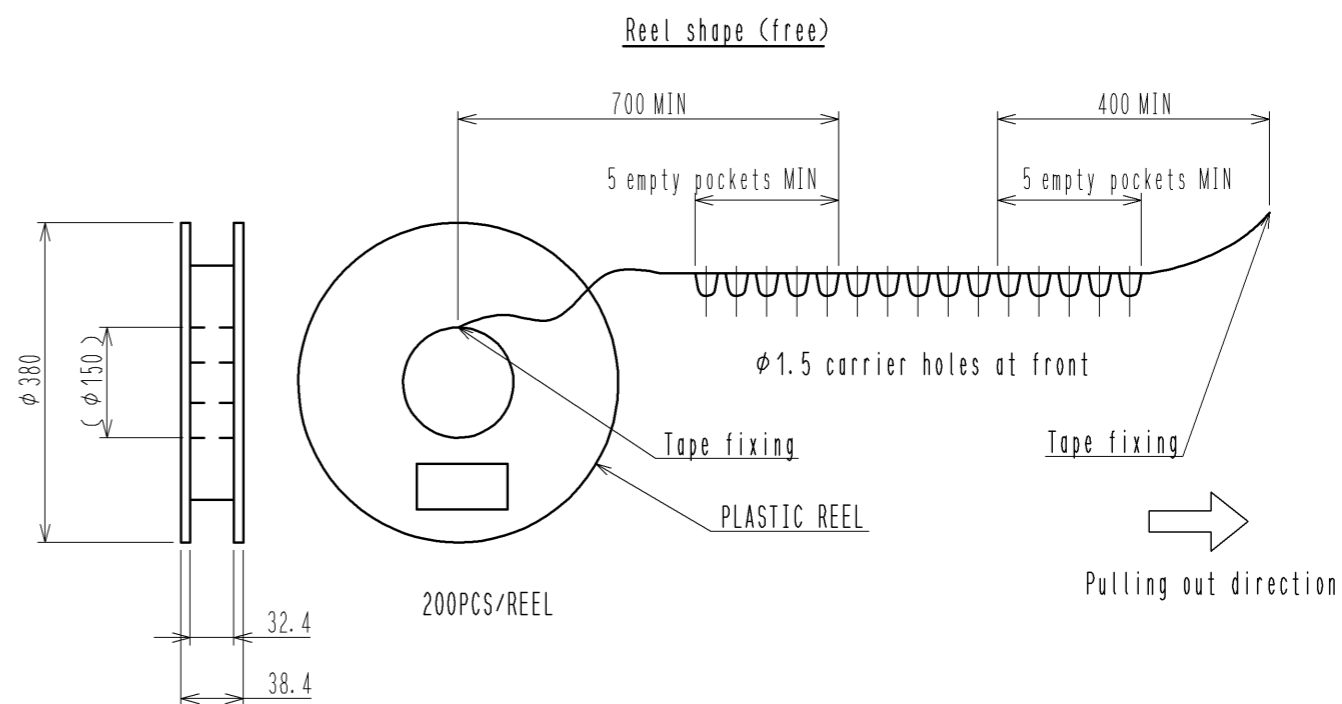
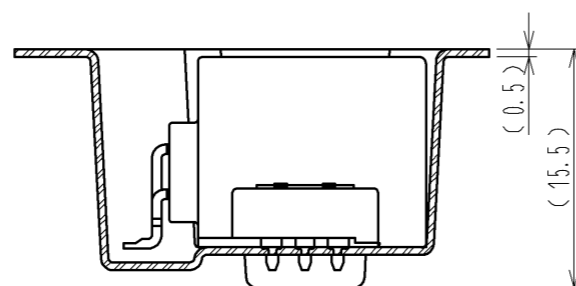
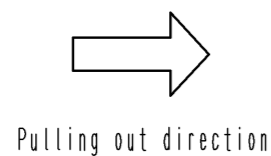
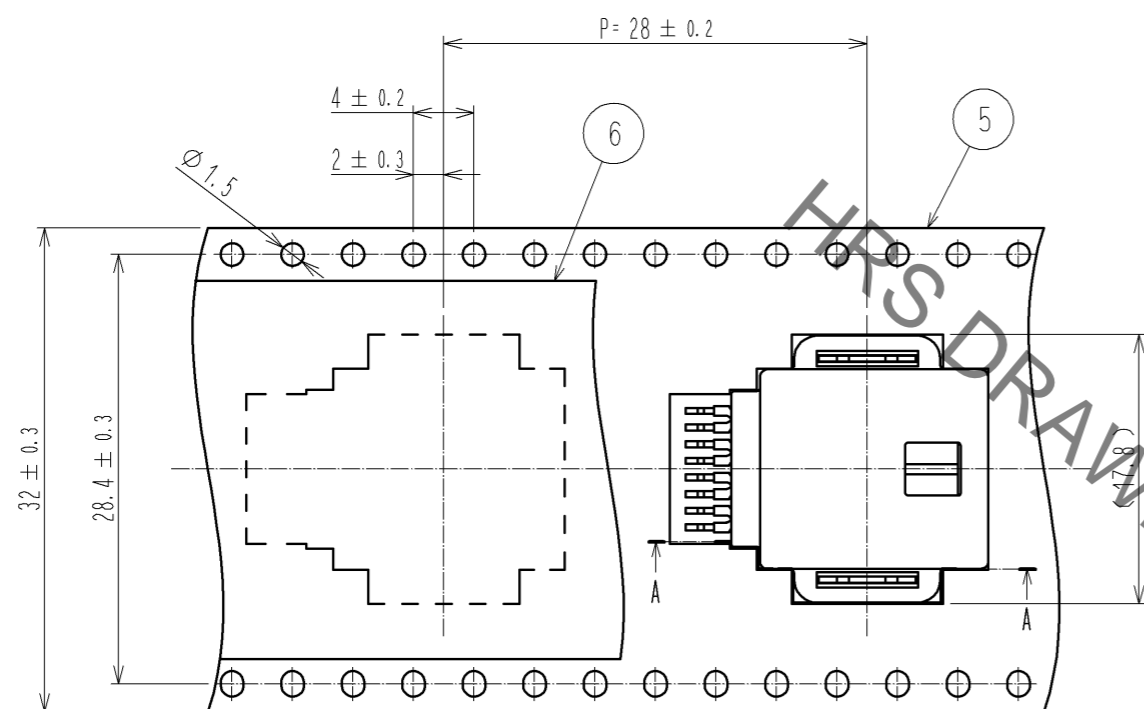

BOX SIZE

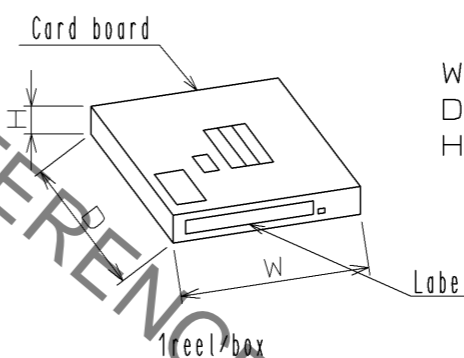

W = (405) (mm)
 D = (405) (mm)
 H = (39) (mm)

Label content (for example)

Product code	775-0004-1-32	Reel number	1RL	Check sign
品名	GT25-12DP-2.2H<32>	数量	200 個	合 DATE 格
PART NO.		QTY		
Product name		Product number		

HRS

図番: EDC3-166406-05
 製品名: GT25-8DP-2.2H<32>
 製品コード: CL775-0004-1-32

△ 2/1

X-ON Electronics

Largest Supplier of Electrical and Electronic Components

Click to view similar products for [Automotive Connectors](#) category:

Click to view products by [Hirose](#) manufacturer:

Other Similar products are found below :

[003-018-000](#) [60403001](#) [60993906-B](#) [M902-2131](#) [M902-2161](#) [72.330.1035.1](#) [73.353.4028.0](#) [F119300-B](#) [F166900](#) [F258300-B](#) [F358300-B](#)
[F407400](#) [F444110](#) [F487000](#) [F509500B-B](#) [827153-1](#) [8N1515-32-24P](#) [9-1326729-8](#) [925474-1](#) [928905-1](#) [964562-4](#) [968782-1](#) [GT17SA-8DS-](#)
[HU](#) [98891-1012](#) [98947-1016](#) [12004475-L](#) [12010290](#) [12010309-B](#) [12015454](#) [12020219-B](#) [12020308](#) [12041318-B](#) [12052225-L](#) [12052466](#)
[12059125](#) [12064869](#) [12004327-B](#) [12010503-B](#) [12015308](#) [12015384](#) [12015909](#) [1-21030-1](#) [12041254](#) [12041318](#) [12047946-B](#) [12047957](#)
[12047957-L](#) [12059473](#) [12066261](#) [12110546](#)