

# GT32 Series

— Shielded connector for high speed transmission / USB3.0, HDMI1.4 —

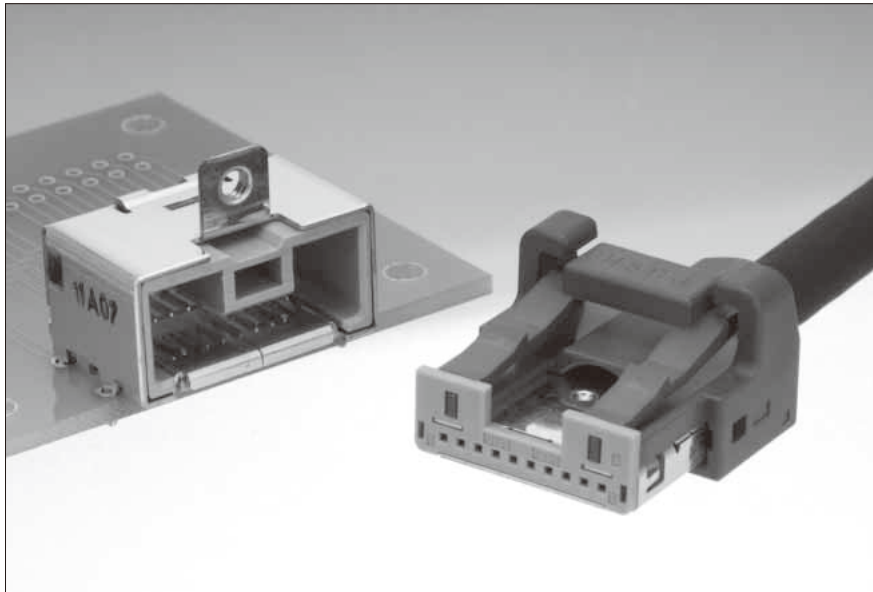

## ■ Features

- Full shielded structure
- Suitable for in-vehicle shielded connectors

## ■ Applications

In-vehicle data communication, etc.  
(10-pos : USB3.0 support)  
(19-pos : HDMI1.4 equivalent signal support)

## F connector

### ● Center terminal

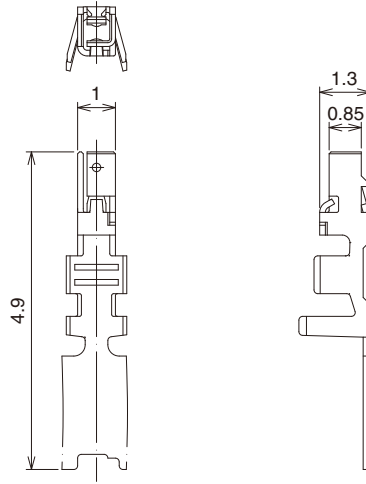
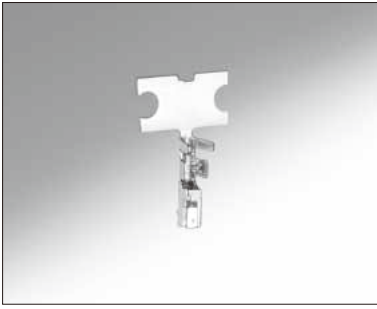

| Part No.     | HRS No.    | Material     | Plating     | Conductor Size (AWG) | Outer Diameter | Packaging       | RoHS |
|--------------|------------|--------------|-------------|----------------------|----------------|-----------------|------|
| GT32-2428SCF | 782-0007-8 | Copper alloy | Tin plating | 24 to 28 AWG         | φ 0.8 to 1.0   | 10,000 pcs/reel | YES  |

## 10-pos straight plug connector

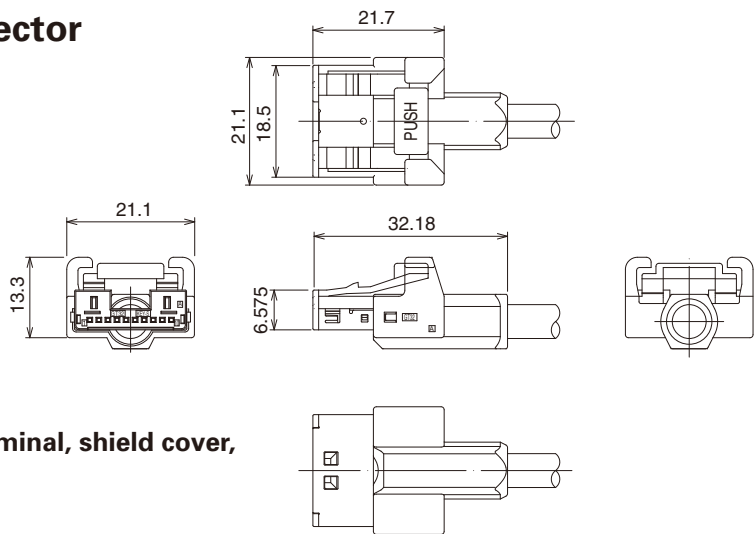
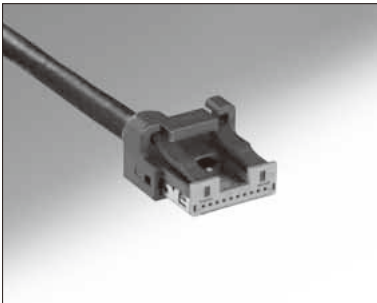

◆ This product consists of six parts.  
(Housing, S insulation case, outer terminal, shield cover, shield plate, center terminal)

### ● Housing

| Part No.    | HRS No.    | Material | Color     | Packaging | RoHS |
|-------------|------------|----------|-----------|-----------|------|
| GT32-10S-HU | 782-0003-7 | PBT      | Dark Gray | 1         | YES  |

### ● S insulation case

| Part No.      | HRS No.    | Material | Color      | Packaging | RoHS |
|---------------|------------|----------|------------|-----------|------|
| GT32-10S-1.5C | 782-0002-4 | PBT      | Light Gray | 1         | YES  |

### ● Outer terminal

| Part No.     | HRS No.    | Material     | Plating     | Outer Diameter | Packaging | RoHS |
|--------------|------------|--------------|-------------|----------------|-----------|------|
| GT32-10S-6CF | 782-0004-0 | Copper alloy | Tin plating | φ 5.4 to 5.8   | 1         | YES  |

### ● Shield cover

| Part No.    | HRS No.    | Material | Plating     | Packaging | RoHS |
|-------------|------------|----------|-------------|-----------|------|
| GT32-10S-SC | 782-0005-2 | Brass    | Tin plating | 1         | YES  |

### ● Shield plate

| Part No.    | HRS No.    | Material | Plating     | Packaging | RoHS |
|-------------|------------|----------|-------------|-----------|------|
| GT32-10S-SP | 782-0006-5 | Brass    | Tin plating | 1         | YES  |

### ● Center terminal

| Part No.     | HRS No.    | Material     | Plating     | Conductor Size (AWG) | Outer Diameter | Packaging       | RoHS |
|--------------|------------|--------------|-------------|----------------------|----------------|-----------------|------|
| GT32-2428SCF | 782-0007-8 | Copper alloy | Tin plating | 24 to 28 AWG         | φ 0.8 to 1.0   | 10,000 pcs/reel | YES  |

## ◆ Mating table

| Color      | Cable connector | Board connector                   |
|------------|-----------------|-----------------------------------|
| Light Gray | GT32-10S-ASSY   | Right-angle type<br>GT32-10P-1.5H |

## ■ 10-pos board connector (right-angle SMT type)

### ● M2.5 screw flange type

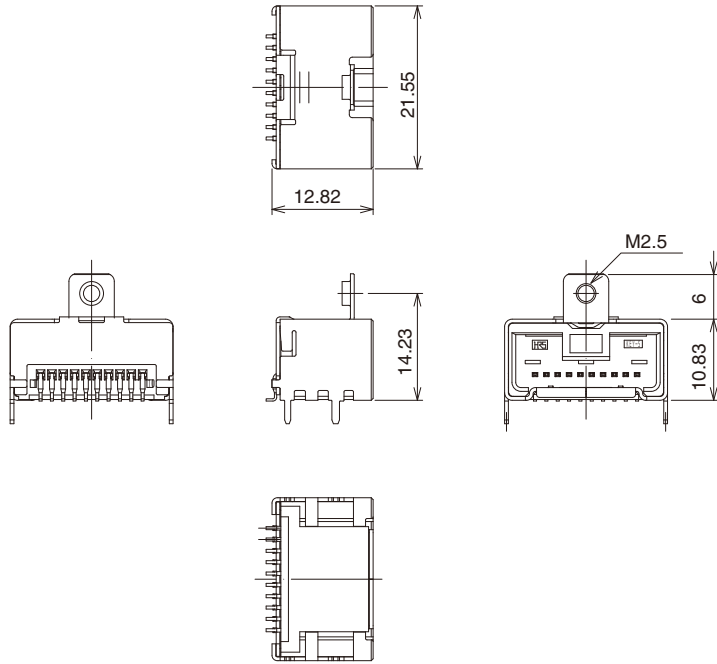
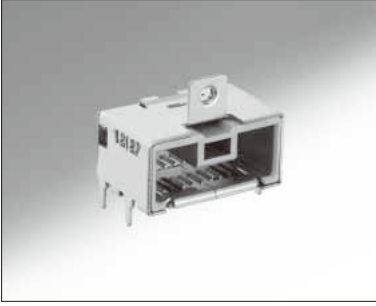

| Part No.      | HRS No.    | Color      | Material/Plating  | Packaging | RoHS |
|---------------|------------|------------|---|-----------|------|
| GT32-10P-1.5H | 782-0001-1 | Light Gray | Housing : PPS<br>Center terminal : Brass/Tin plating<br>Outer terminal : Copper alloy/Tin plating | 1         | YES  |

## ■ 19-pos straight connector

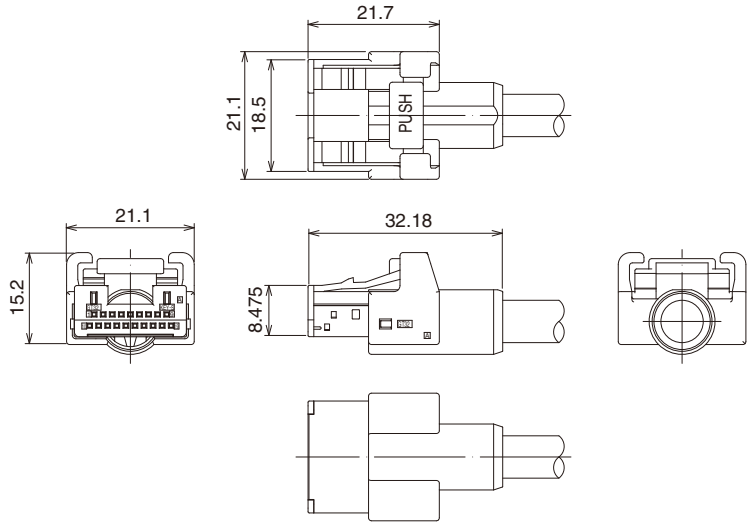
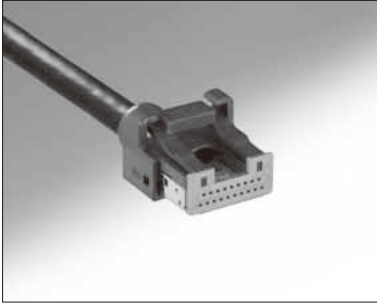

◆ This product consists of six parts.  
 (Housing, S insulation case A, S insulation case B,  
 outer terminal, shield cover, center terminal)

### ● Housing

| Part No.     | HRS No.    | Material | Color     | Packaging | RoHS |
|--------------|------------|----------|-----------|-----------|------|
| GT32-19DS-HU | 782-0013-0 | PBT      | Dark Gray | 1         | YES  |

### ● S insulation case A

| Part No.         | HRS No.    | Material | Color      | Packaging | RoHS |
|------------------|------------|----------|------------|-----------|------|
| GT32-19DS-0.75CA | 782-0010-2 | PBT      | Light Gray | 1         | YES  |

### ● S insulation case B

| Part No.         | HRS No.    | Material | Color      | Packaging | RoHS |
|------------------|------------|----------|------------|-----------|------|
| GT32-19DS-0.75CB | 782-0014-3 | PBT      | Light Gray | 1         | YES  |

### ● Outer terminal

| Part No.      | HRS No.    | Material     | Plating     | Outer Diameter | Packaging | RoHS |
|---------------|------------|--------------|-------------|----------------|-----------|------|
| GT32-19DS-7CF | 782-0011-5 | Copper alloy | Tin plating | φ 6.8 to 7.2   | 1         | YES  |

### ● Shield cover

| Part No.     | HRS No.    | Material | Plating     | Packaging | RoHS |
|--------------|------------|----------|-------------|-----------|------|
| GT32-19DS-SC | 782-0012-8 | Brass    | Tin plating | 1         | YES  |

### ● Center terminal

| Part No.     | HRS No.    | Material     | Plating     | Conductor Size (AWG) | Outer Diameter | Packaging       | RoHS |
|--------------|------------|--------------|-------------|----------------------|----------------|-----------------|------|
| GT32-2428SCF | 782-0007-8 | Copper alloy | Tin plating | 24 to 28 AWG         | φ 0.8 to 1.0   | 10,000 pcs/reel | YES  |

## ◆ Mating table

| Color      | Cable connector | Board connector  |                   |
|------------|-----------------|------------------|-------------------|
|            |                 | Right-angle type | DIP type          |
| Light Gray | GT32-19DS-ASSY  | GT32-19DP-0.75H  | GT32-19DP-0.75DSA |

Dec.1.2018 Copyright © 2018 HIROSE ELECTRIC CO., LTD. All Rights Reserved.

GT5  
GT13  
GT16  
PO5G  
GT19  
GT21  
GT26  
GT36  
GT11  
GT17  
GT32  
GT3  
GT7  
GT10  
GT18W  
GT25  
GT8E  
GT9  
GT15

## ■ 19-pos board connector (right-angle SMT type)

### ● M2.5 screw flange type

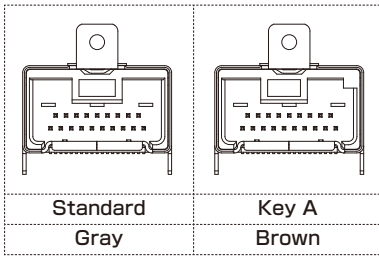
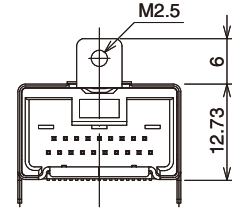
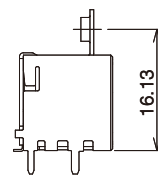
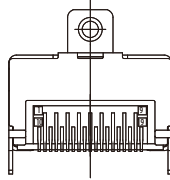
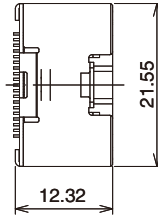
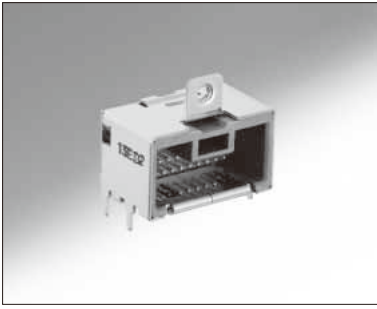

Standard  
Gray

Key A  
Brown

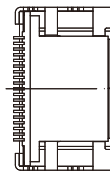

| Part No.           | HRS No.    | Color | Material/Plating   | Packaging | RoHS |
|--------------------|------------|-------|--|-----------|------|
| GT32-19DP-0.75H    | 782-0009-3 | Gray  | Housing : PA<br>Center terminal : Brass/Tin plating<br>Outer terminal : Copper alloy/Tin plating | 1         | YES  |
| GT32-19DP-0.75H(A) | 782-0015-6 | Brown |  |           |      |

## ■ 19-pos board connector (straight DIP type)

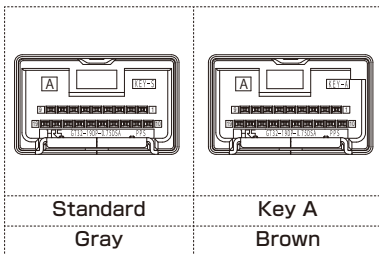
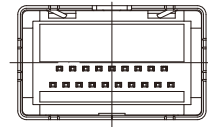
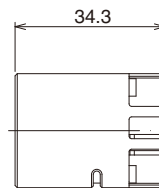
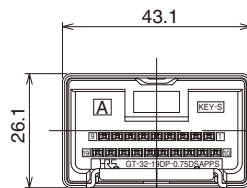
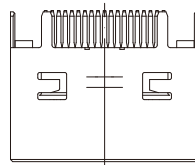

Standard  
Gray

Key A  
Brown

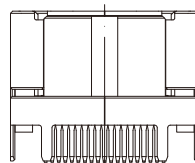

| Part No.              | HRS No.    | Color | Material/Plating  | Packaging | RoHS |
|-----------------------|------------|-------|---|-----------|------|
| GT32-19DP-0.75DSA     | 782-0037-9 | Gray  | Housing : PPS<br>Center terminal : Brass/Tin plating<br>Outer terminal : Copper alloy/Tin plating | 1         | YES  |
| GT32-19DP-0.75DSA (A) | 782-0045-7 | Brown |   |           |      |

## ◆ Crimping tools

Operation manuals are available for each crimp tool. Please contact sales personnel.

### ● Automatic Crimping Machine

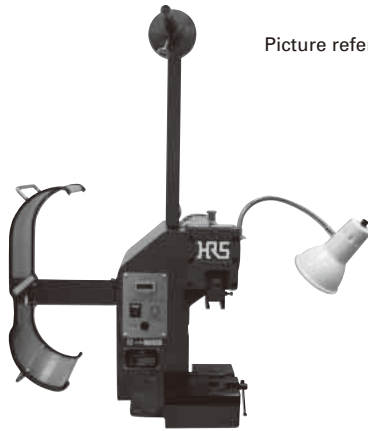

Picture reference only

#### Specifications

| Item              | Specification         | Remarks       |
|-------------------|-----------------------|---------------|
| Press capacity    | 1.5Ton                |               |
| Stroke length     | 30mm                  |               |
| Number of strokes | 200spm (50Hz)         | 240spm (60Hz) |
| Weight            | 75kg                  |               |
| Motor             | 0.2kW                 | AC100V        |
| Crimping speed    | 2000 to 4000 pcs/hour |               |

Part No. CM-105C

Note : Please refer to the table below for applicator product numbers.

#### Applicator (for use with the automatic crimping machine)

| Terminal Product No. | Terminal HRS No. | Tool Product No. | Tool HRS No.  |
|----------------------|------------------|------------------|---------------|
| GT32-2428SCF         | 782-0007-8       | AP105-GT32-2428S | 901-5223-2 00 |

Note 1 : The crimp height is to be set for each cable type. Please request your contact person for details.

Note 2 : The P/N for applicator/tool may differ from the above P/N depending on the cable specification.

#### Special terminal insertion tool for GT32-10S-1.5C

| Terminal Product No. | Terminal HRS No. | Tool No.       | Tool HRS No. |
|----------------------|------------------|----------------|--------------|
| GT32-2428SCF         | 782-0007-8       | GT32-CON/PR-MD | 902-5125-0   |

\* This product is used only to insert GT32-2428SCF terminal into S insulation case GT32-10S-1.5C.

Please note that this product cannot be used for other terminals and insulation cases.

### ● Hand press

Hand press

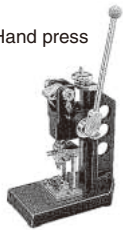

Product No. HOS-7

#### Outer terminal applicator (for hand press mounting)

| Product Part No. | Product HRS No. | Tool Part No.         | Tool HRS No.  |
|------------------|-----------------|-----------------------|---------------|
| GT32-10S-6CF     | 782-0004-0      | GT32-10S-6/CR-MP      | 902-5118-4 00 |
|                  |                 | GT32-10S-6/CR-MP(01)  | 902-5118-4 01 |
| GT32-19DS-7CF    | 782-0011-5      | GT32-19DS-7/CR-MP     | 902-5124-7 00 |
|                  |                 | GT32-19DS-7/CR-MP(01) | 902-5124-7 01 |

Note 1 : (01) version is to be supplied with the hand press "HOS-7".

Note 2 : The crimp height is to be set for each cable type. Please request your contact person for details.

Note 3 : The P/N for applicator/tool may differ from the above P/N depending on the cable specification.

## X-ON Electronics

Largest Supplier of Electrical and Electronic Components

*Click to view similar products for [Automotive Connectors](#) category:*

*Click to view products by [Hirose](#) manufacturer:*

Other Similar products are found below :

[003-018-000](#) [60403001](#) [60993906-B](#) [M902-2131](#) [M902-2161](#) [72.330.1035.1](#) [73.353.4028.0](#) [F119300-B](#) [F166900](#) [F258300-B](#) [F358300-B](#)  
[F407400](#) [F444110](#) [F487000](#) [F509500B-B](#) [827153-1](#) [8N1515-32-24P](#) [9-1326729-8](#) [925474-1](#) [928905-1](#) [964562-4](#) [968782-1](#) [GT17SA-8DS-](#)  
[HU](#) [98891-1012](#) [98947-1016](#) [12004475-L](#) [12010290](#) [12010309-B](#) [12015454](#) [12020219-B](#) [12020308](#) [12041318-B](#) [12052225-L](#) [12052466](#)  
[12059125](#) [12064869](#) [12004327-B](#) [12010503-B](#) [12015308](#) [12015384](#) [12015909](#) [1-21030-1](#) [12041254](#) [12041318](#) [12047946-B](#) [12047957](#)  
[12047957-L](#) [12059473](#) [12066261](#) [12110546](#)