

# GT5 Series

— Connectors for Coaxial Cables —

(In-line type, Board type, Hybrid type, Waterproof type)

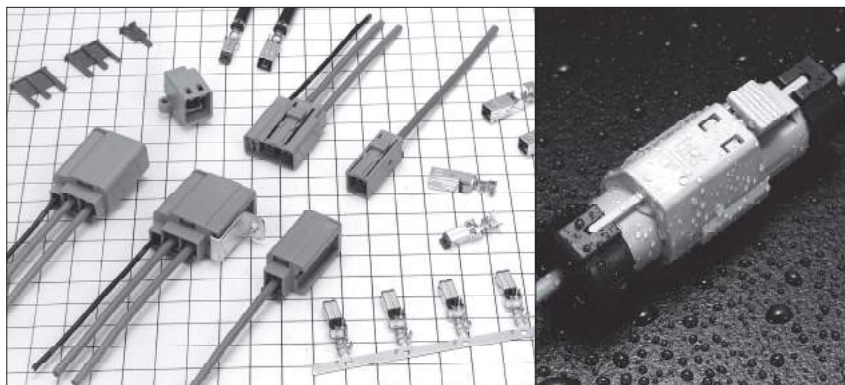

## ■ Features

### ● Cost performance:

Labor costs can be kept low because signal wires and shield wires can be crimped in one step. Additionally, the cable assembly process is semi-automatic.

### ● Excellent high frequency performance

Please refer to V.S.W.R data on the following pages.

## ■ Applications

For car TV, radio antenna, etc.

## ◆ TEST DATA (using 1.5D-2V Type cable)

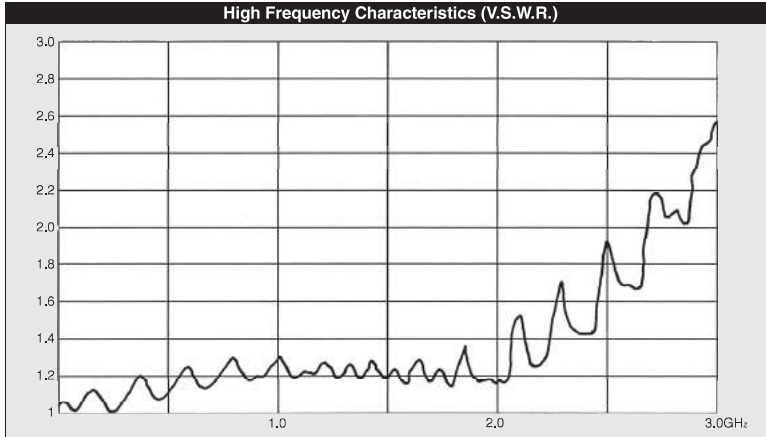

(Note) The above measurement data is for GT5-1S-HU and GT5-1PP-HU.

## ◆ Cable Assembly Instructions

1. Strip the cable.

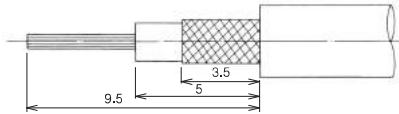

3. Insert the terminal into the housing. (Push it in until the housing lance latches.)

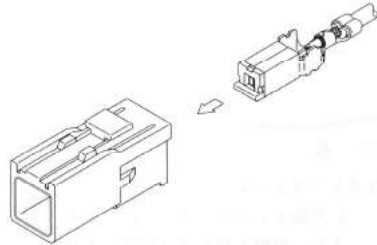

2. Crimp the cable to the terminal.

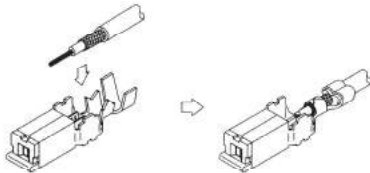

4. Attach the retainer (Push in the retainer until it locks.)

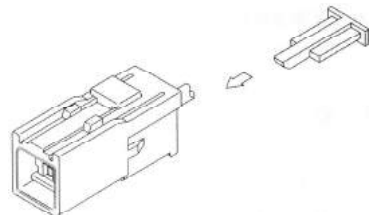

## Terminal for Coaxial Cable

### F Connector Terminals

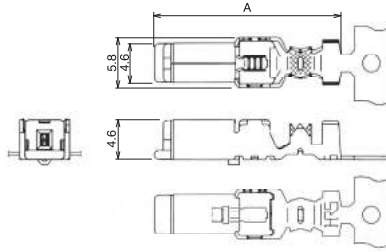

Part No.	HRS No.	Material / Finish or color	Conductor size	Insulator outer diameter	Jacket outer diameter	A	Sales unit	RoHS
GT5-30/0.7-1.5SCF(70)	755-0065-1 70	Insulator : PBT/Dark gray Center terminal : Phosphor bronze/Tin plating Outer terminal : Brass/Tin plating	AWG#30	φ0.6~0.9	φ1.4~1.8	22.7	1,300pcs/reel	○
GT5-2428/1.1-2.2SCF(70)	755-0123-6		AWG#24~28	φ1.0~1.4	φ2.0~2.4	21.7		
GT5-2428/1.6-2.5SCF(70)	755-0078-3 70		AWG#30	φ1.5~2.0	φ2.3~2.7			
GT5-30/1.6-2.9SCF(70)	755-0022-9 70				φ2.6~3.4			
GT5-2428/1.6-2.9SCF(70)	755-0002-1 70		AWG#20~22	φ2.0~2.5	φ3.3~3.7	22.7		
GT5-2022/1.6-2.9SCF(70)	755-0071-4 70				φ3.6~4.0			
GT5-2022/F2.7-3.5SCF(70)	755-0077-0 70		AWG#30	φ2.5~2.9	φ4.6~5.0	1,100pcs/reel		
* GT5-2022/F3.3-3.8SCF(70)	755-0054-5 70							
* GT5-30/F3.3-5SCF(70)	755-0016-6 70							
* GT5-2428/F3.3-5SCF(70)	755-0012-5 70							
* GT5-2022/F3.3-5SCF(70)	755-0034-8 70							
* GT5-30/F4-5SCF(70)	755-0020-3 70							
* GT5-2428/F4-5SCF(70)	755-0024-4 70	AWG#24~28	φ3.0~3.6	AWG#20~22				
* GT5-2022/F4-5SCF(70)	755-0036-3 70							

Note : Products marked with an asterisk (\*) support insulators made of polyethylene foam.

### M Connector Terminals

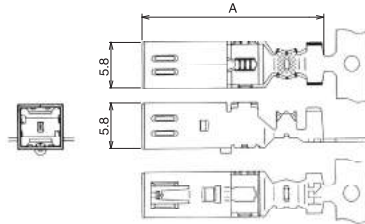

Part No.	HRS No.	Material / Finish or color	Conductor size	Insulator outer diameter	Jacket outer diameter	A	Sales unit	RoHS
GT5-30/0.7-1.5PCF(70)	755-0017-9 70	Insulator : PBT/Dark gray Center terminal : Brass/Tin plating Outer terminal : Brass/Tin plating	AWG#30	φ0.6~0.9	φ1.4~1.8	24.05	900pcs/reel	○
GT5-30/1.6-2.9PCF(70)	755-0021-6 70		AWG#24~28	φ1.5~2.0	φ2.6~3.4	23.05		
GT5-2428/1.6-2.9PCF(70)	755-0001-9 70		AWG#20~22					
GT5-2022/1.6-2.9PCF(70)	755-0094-0 70			φ2.5~2.9	φ3.6~4.0			
GT5-2022/F2.7-3.5PCF(70)	755-0076-8 70		AWG#30			φ2.5~2.9		
* GT5-2022/F3.3-3.8PCF(70)	755-0053-2 70							
* GT5-30/F3.3-5PCF(70)	755-0015-3 70		AWG#24~28	φ3.0~3.6	AWG#20~22			
* GT5-2428/F3.3-5PCF(70)	755-0011-2 70							
* GT5-2022/F3.3-5PCF(70)	755-0033-5 70							
* GT5-30/F4-5PCF(70)	755-0019-4 70							
* GT5-2428/F4-5PCF(70)	755-0023-1 70							
* GT5-2022/F4-5PCF(70)	755-0035-0 70							

Note : Products marked with an asterisk (\*) support insulators made of polyethylene foam.

### Terminal for Low-insertion M Connector

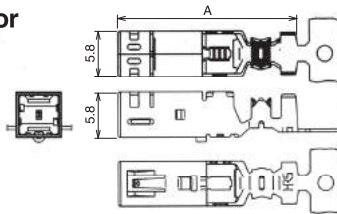

Part No.	HRS No.	Material / Finish or color	Conductor size	Insulator outer diameter	Jacket outer diameter	A	Sales unit	RoHS
GT5L-30/0.7-1.5PCF(70)	755-0068-0 70	Insulator : PBT/Dark gray Center terminal : Brass/Tin plating Outer terminal : Brass/Tin plating	AWG#30	φ0.6~0.9	φ1.4~1.8	24.05	900pcs/reel	○
GT5L-2428/1.6-2.5PCF(70)	755-0079-6 70		AWG#24~28					
GT5L-30/1.6-2.9PCF(70)	755-0067-7 70		AWG#30	φ2.6~3.4				
GT5L-2428/1.6-2.9PCF(70)	755-0066-4 70		AWG#24~28					

## 1 Pos. for Coaxial Cable

### ■ F Connector

#### ● Housing



GT5-1S-HU

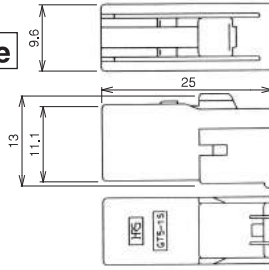

#### ◆ Shown with retainer inserted.

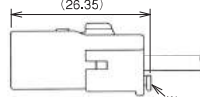

\*Use together with separate retainer (GT5-1P/S-R) sold separately.

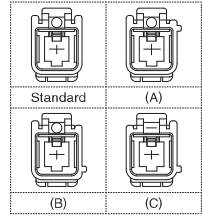

Part No.	HRS No.	Material	Color	Key position	Corresponding M Connector Housing	Corresponding M Connector Board-Mounting	Sales unit	RoHS
GT5-1S-HU	755-0004-7	PBT	Light gray	Standard	GT5-1PP-HU(70)	GT5-1P-DS(70)	1	○
GT5-1S-HU(A)	755-0037-6		Brown	(A)	GT5-1PP-HU(A)(70)	GT5-1P-DS(A)(70)		
GT5-1S-HU(B)	755-0038-9		Green	(B)	GT5-1PP-HU(B)(70)	GT5-1P-DS(B)(70)		
GT5-1S-HU(C)	755-0080-5		Blue	(C)	GT5-1PP-HU(C)(70)	GT5-1P-DS(C)(70)		

\*M connector mating table (Use types with matching key positions as described above.)

#### ● Retainer (Used with: GT5-1S-HU, GT5-1PP-HU, GT5N-1PP-HU, GT5H-1PP-HU)



Part No.	HRS No.	Material	Color	Sales unit	RoHS
GT5-1P/S-R	755-0006-2	PBT	Dark gray	1	○

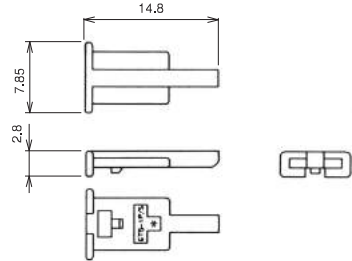

#### ● Housing (Retainer Not Required)



GT5R-1S-HU

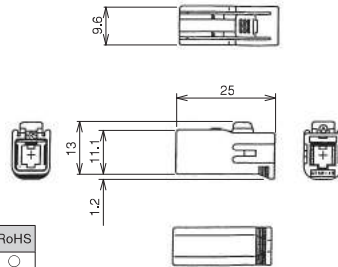

Part No.	HRS No.	Material	Color	Sales unit	RoHS
GT5R-1S-HU	755-0047-0	PBT	Light gray	1	○

GT5  
GT13  
GT16  
GT19  
All Rights Reserved.  
HIROSE ELECTRIC CO., LTD.  
FH65  
FH40  
FH35  
FH67

## M Connector

### ● Housing

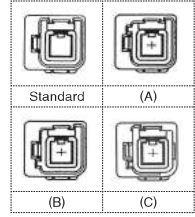
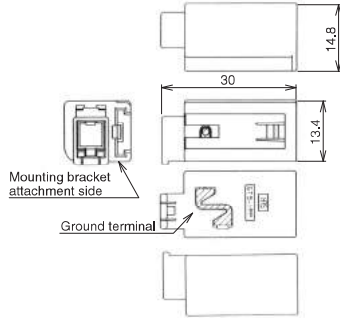

### ◆ Shown with retainer inserted.

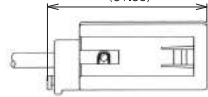

\*Use together with separate retainer (GT5-1P/S-R) sold separately.

Part No.	HRS No.	Corresponding F Connector Housing	Material / Finish	Color	Key position	Sales unit	RoHS
GT5-1PP-HU(70)	755-0005-0 70	GT5-1S-HU	Housing: PBT	Light gray	Standard	1	○
GT5-1PP-HU(A)(70)	755-0039-1 70	GT5-1S-HU (A)	Ground terminal: Phosphor bronze/Tin plating	Brown	(A)		
GT5-1PP-HU(B)(70)	755-0040-0 70	GT5-1S-HU (B)		Green	(B)		
GT5-1PP-HU(C)(70)	755-0103-9 70	GT5-1S-HU (C)		Blue	(C)		

\*See page 17 for panel mounting in-line bracket.

\*Please use a corresponding F connector housing with a matching key type.

### ● Housing (H type bracket)

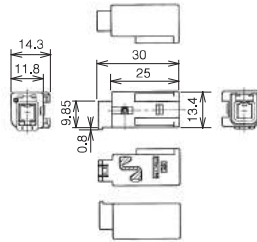

### ◆ Mated Connector

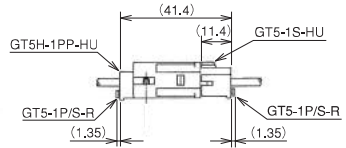

\*Use together with separate retainer (GT5-1P/S-R) sold separately.

Part No.	HRS No.	Material	Color	Corresponding F Connector	Sales unit	RoHS
GT5H-1PP-HU(10)	755-0093-7 10	PBT	Light gray	GT5-1S-HU GT5R-1S-HU	1	○

### ● Housing (N type bracket)

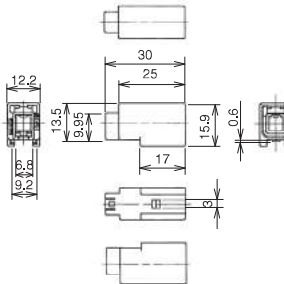
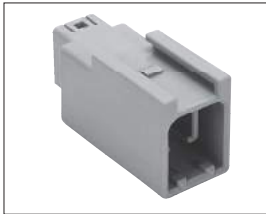

### ◆ Mated Connector

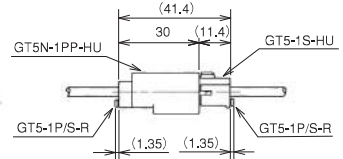

\*Use together with separate retainer (GT5-1P/S-R) sold separately.

Part No.	HRS No.	Material	Color	Corresponding F Connector	Sales unit	RoHS
GT5N-1PP-HU	755-0090-9	PBT	Light gray	GT5-1S-HU GT5R-1S-HU	1	○

GT5  
 GT13  
 GT16  
 GT19  
 GT21  
 GT36  
 GT43  
 GT17  
 GT32  
 GT25  
 KM37  
 ZE05  
 ZG01/2  
 HM-H-200  
 ZEK64W  
 H2071L  
 FX26  
 DE40  
 DE40GL  
 FH28K  
 FH52K  
 FH65  
 FH40  
 FH63S  
 FH67

● Housing

〔 Panel Mount type  
Enforced Shield type 〕

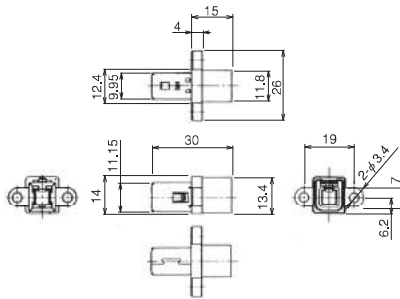

◆ Recommended Panel Dimensions

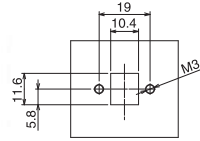

◆ Mated Connector

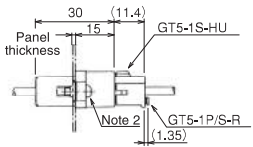

Part No.	HRS No.	Material / Finish or color	Corresponding F Connector	Sales unit	RoHS
GT5A-1PP-HU(70)	755-0025-7 70	Housing : PBT/ Light gray Ground terminal : Brass/Tin plating	GT5-1S-HU GT5R-1S-HU	1	○

Note 1 : This product does not require a retainer.

Note 2 : Use M3 screws listed in JIS B 1111 and 1101 M3 screws for mounting screws.

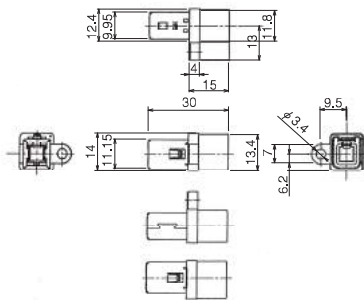

◆ Recommended Panel Dimensions

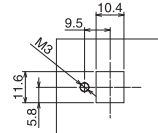

Part No.	HRS No.	Material / Finish or color	Corresponding F Connector	Sales unit	RoHS
GT5P-1PP-HU(70)	755-0030-7 70	Housing : PBT/ Light gray Ground terminal : Brass/Tin plating	GT5-1S-HU GT5R-1S-HU	1	○

Note 1 : This product does not require a retainer.

Note 2 : Use M3 screws listed in JIS B 1111 and 1101 M3 screws for mounting screws.

Sep. 1, 2021 Copyright 2021 HIROSE ELECTRIC CO., LTD., All Rights Reserved. GT5 GT13 GT16 GT19 FH65 FH40 FH35 FH67

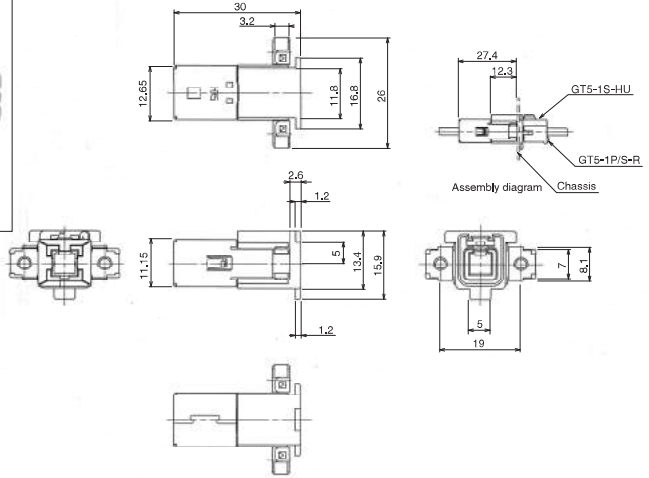

Part No.	HRS No.	Material / Finish or color	Corresponding F Connector	Sales unit	RoHS
GT5B-1PP-HU(70)	755-0051-7 70	Housing : PBT/ Light gray Ground terminal : Phosphor bronze/Tin plating	GT5-1S-HU GT5R-1S-HU	1	○

Note 1 : This product does not require a retainer.

Note 2 : Use JIS B 1115 and 1122 class 4, nominal diameter 3, length 6 screws for the mounting screws.

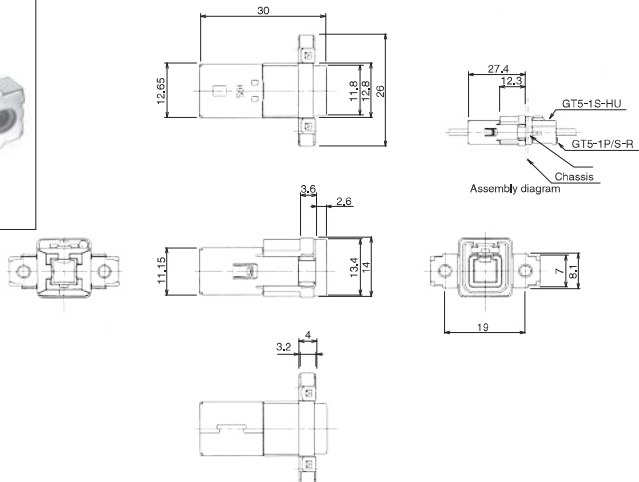

Part No.	HRS No.	Material / Finish or color	Corresponding F Connector	Sales unit	RoHS
GT5S-1PP-HU(70)	755-0050-4 70	Housing : PBT/ Light gray Ground terminal : Phosphor bronze/Tin plating	GT5-1S-HU GT5R-1S-HU	1	○

Note 1 : This product does not require a retainer.

Note 2 : Use JIS B 1115 and 1122 class 4, nominal diameter 3, length 6 screws for the mounting screws.

GT5  
 GT13  
 GT16  
 GT19  
 GT21  
 GT36  
 GT43  
 GT17  
 GT32  
 GT25  
 KM37  
 ZE05  
 Z00512  
 HM-5-200  
 Z0064W  
 H2071L  
 FX26  
 DF40  
 DF40GL  
 FH28K  
 FH2K  
 FH65  
 FH40  
 FH63S  
 FH67

● Board Mount type

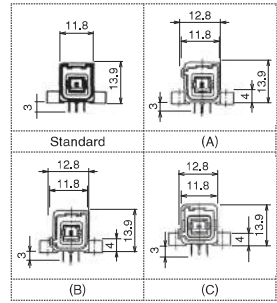
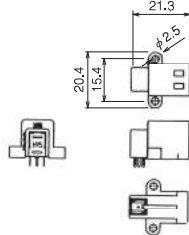

◆ Mated Connector

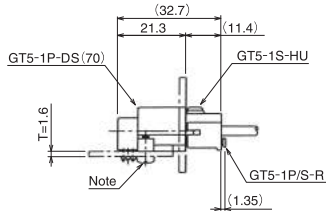

◆ Recommended Board Dimensions

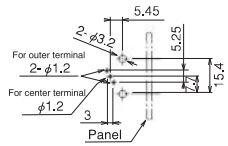

Part No.	HRS No.	Material / Finish or color	Color	Key position	Corresponding connector	Sales unit	RoHS
GT5-1P-DS(70)	755-0007-5 70	Housing: PBT	Light gray	Standard	GT5-1S-HU	1	○
GT5-1P-DS(A)(70)	755-0041-3 70	Center terminal: Brass/Tin plating	Brown	(A)	GT5-1S-HU(A)		
GT5-1P-DS(B)(70)	755-0042-6 70	Insulator: PBT/Dark gray	Green	(B)	GT5-1S-HU(B)		
GT5-1P-DS(C)(70)	755-0083-3 70	Outer terminal: Phosphor bronze/Tin plating	Blue	(C)	GT5-1S-HU(C)		

Note : Use JIS B 1115 and 1122 class 4, nominal diameter 3, length 6 screws (for a board thickness of 1.6 mm) for the mounting screws.  
 \*Six types of keys are available.  
 Please use a corresponding F connector housing with a matching key type.

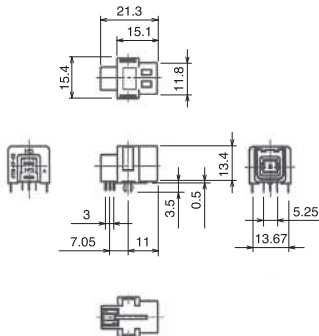

◆ Mated Connector

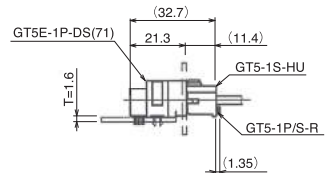

◆ Recommended Board Dimensions

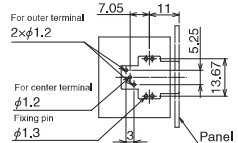

Part No.	HRS No.	Material / Finish or color	Corresponding connector	Sales unit	RoHS
GT5E-1P-DS(71)	755-0125-1 71	Housing: PA/ Natural Center terminal: Brass/Tin plating Insulator: PA/Black Outer terminal: Phosphor bronze/Tin plating Fixing pin: Brass/ Tin plating	GT5-1S-HU GT5R-1S-HU	1	○



# 1 Pos. for Coaxial Cable, Waterproof type

## ■ F Connector

### ● Housing

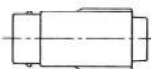
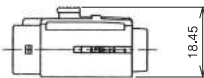
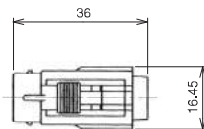

Part No.	HRS No.	Material	Color	Sales unit	RoHS
GT5W-1S-HU	755-0027-2	PBT	Light gray	1	○

Note : Use this product with a retainer that matches the cable.

### ● Retainer (Used with: GT5W-1PP-HU, GT5JW-1PP-HU, GT5W-1S-HU, GT5W-1P-HU)

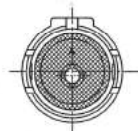
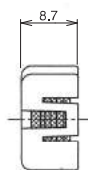
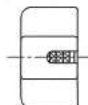
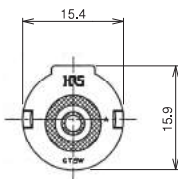

Part No.	HRS No.	Material / Finish or color	Sales unit	RoHS
GT5W-1P/S-R	755-0028-5	Retainer : PBT/Dark gray Rubber : Silicon rubber/Light blue	1	○

\*This product supports cables with outer diameters of  $\phi 2.9$  to  $\phi 3.4$ .  
Waterproofness will depend on the cable, Please contact Hirose Electric if you intend to use cables other than those recommended.

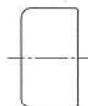

## M Connector

### ● Housing

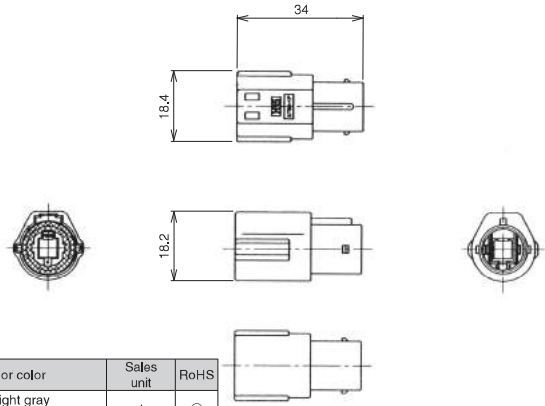

Part No.	HRS No.	Material / Finish or color	Sales unit	RoHS
GT5W-1P-HU	755-0026-0	Housing : PBT/ Light gray Connector seal : Silicon rubber/White	1	○

Note : Use this product with a retainer that matches the cable.

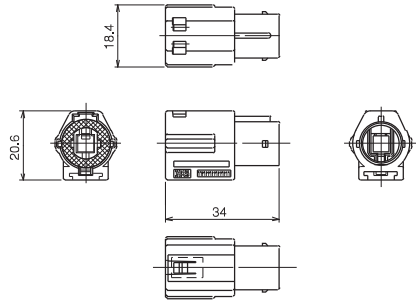

### ◆ Recommended Bracket Dimensions (Used with GT5W-1PP-HU)

Please check with Hirose for information on the bracket for GT5JW-1PP-HU.

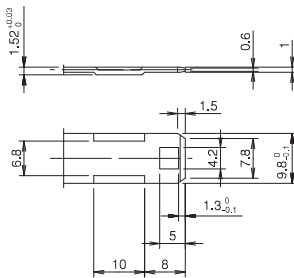

Part No.	HRS No.	Material / Finish or color	Sales unit	RoHS
GT5W-1PP-HU	755-0070-1	Housing : PBT/ Light gray	1	○
GT5JW-1PP-HU	755-0069-2	Connector seal : Silicon rubber/White		

Note : Use this product with a retainer that matches the cable.

### ◆ Mated Connector

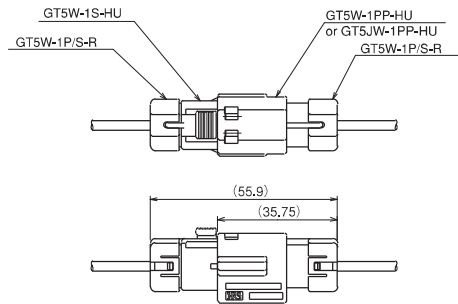

# G Terminal

## ■ For Cable Termination Part

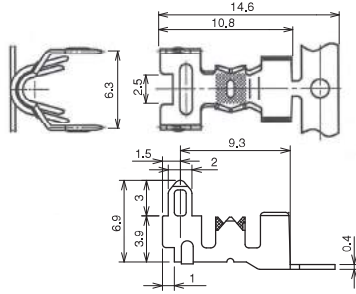
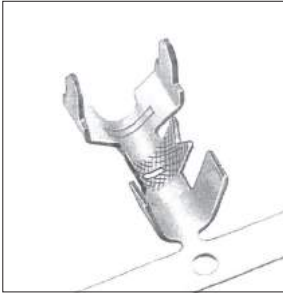

### ◆ Recommended Cable Assembly Diagram

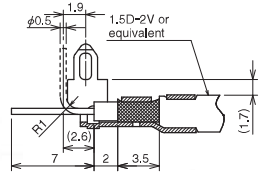

### ◆ Recommended Board Dimensions

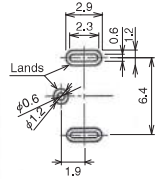

Part No.	HRS No.	Material	Finish	Sales unit	RoHS
GTA-1.6CF(70)	755-0032-2 70	Brass	Tin plating	1,500 pcs/reel	○

### ◆ Recommended Cable Assembly Diagram

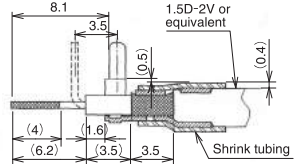
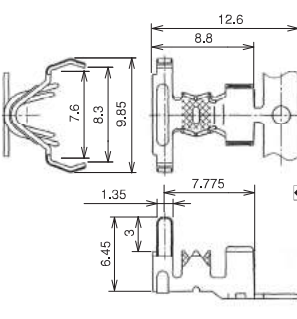
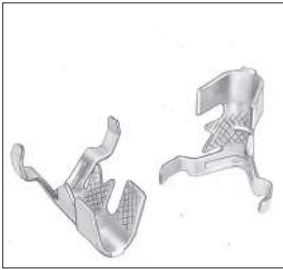

### ◆ Recommended Board Dimensions

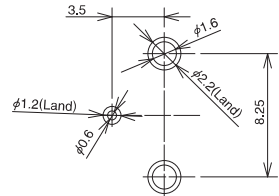

Part No.	HRS No.	Material	Finish	Sales unit	RoHS
GTB-1.6CF(70)	755-0049-5 70	Brass	Tin plating	1,500 pcs/reel	○

### ◆ Recommended Cable Assembly Diagram

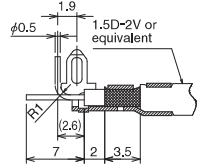
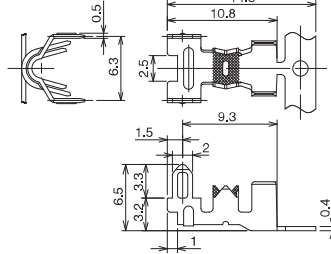

### ◆ Recommended Board Dimensions

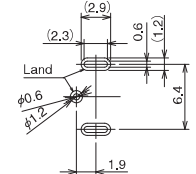

Part No.	HRS No.	Material	Finish	Sales unit	RoHS
GTG-1.6CF	755-0106-7	Brass	Tin plating	1,500 pcs/reel	○

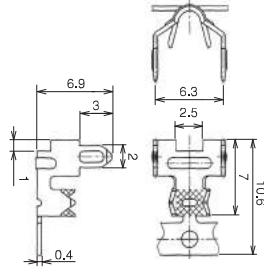
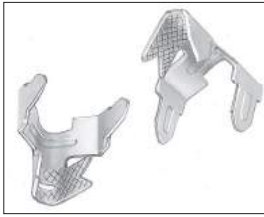

Part No.	HRS No.	Material	Finish	Sales unit	RoHS
G-1.6PCF(70)	755-0029-8 70	Brass	Tin plating	1,500 pcs/reel	○

Recommended Cable Assembly Diagram

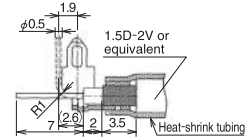

Recommended Board Dimensions

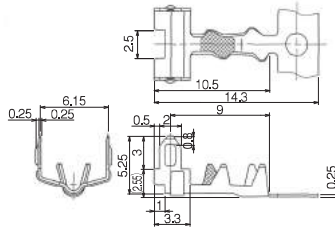
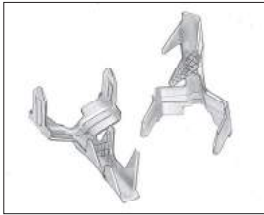
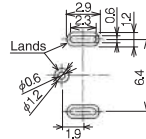

Part No.	HRS No.	Material	Finish	Sales unit	RoHS
GTA-0.7CF	755-0074-2	Brass	Tin plating	1,500 pcs/reel	○

Recommended Cable Assembly Diagram

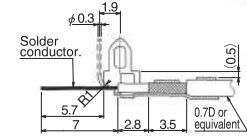

Recommended Board Dimensions

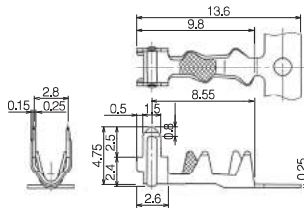
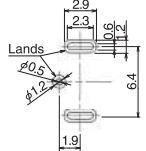

Part No.	HRS No.	Material	Finish	Sales unit	RoHS
GTB-0.7CF	755-0075-5	Brass	Tin plating	1,500 pcs/reel	○

Recommended Cable Assembly Diagram

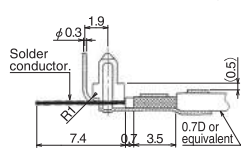

Recommended Board Dimensions

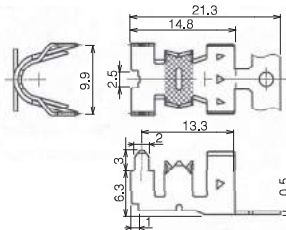
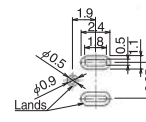

Part No.	HRS No.	Material	Finish	Sales unit	RoHS
GTE-3.7CF	755-0122-3	Brass	Tin plating	1,100 pcs/reel	○

Recommended Cable Assembly Diagram

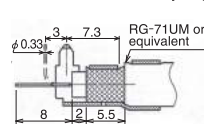

Recommended Board Dimensions

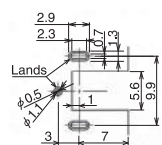

Sep. 1. 2021 Copyright 2021 HIROSE ELECTRIC CO., LTD. All Rights Reserved.

GT5  
 GT13  
 GT16  
 GT19  
 GT21  
 GT36  
 GT43  
 GT17  
 GT32  
 GT25  
 KM37  
 ZE05  
 Z05012  
 H10-320  
 Z05K4W  
 H2011  
 FK26  
 DE40  
 DF40GL  
 FH28K  
 FH2K  
 FH65  
 FH40  
 FH635  
 FH67

GT5 GT13 GT16 GT19 GT21  
 Sep. 1, 2021 Copyright 2021 HIROSE ELECTRIC CO., LTD., All Rights Reserved.  
 FH65 FH40 FH35 FH27

## Shield Plate

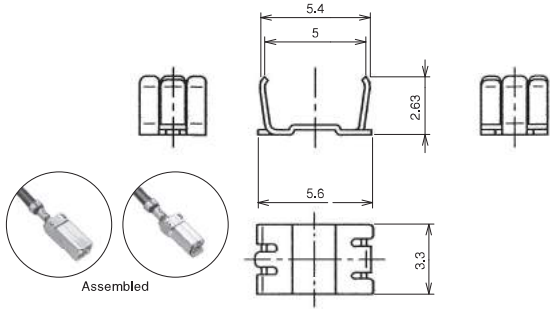

Part No.	HRS No.	Material	Finish	Sales unit	RoHS
GT5C-1P/S-CSB(70)	755-0048-2 70	Brass	Tin plating	1	○

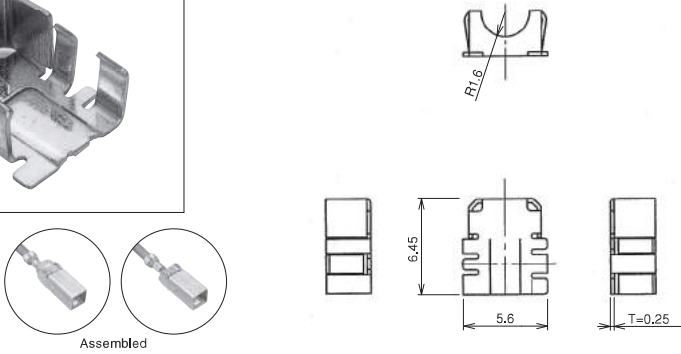
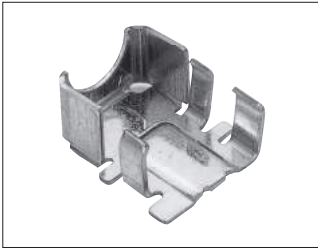

Part No.	HRS No.	Material	Finish	Sales unit	RoHS
GT5C-1P/S-CSB(70)	755-0088-7 70	Brass	Tin plating	1	○

## Panel Mount In-line Bracket

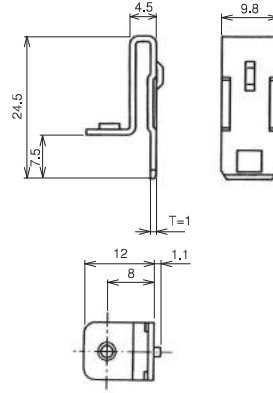

Part No.	HRS No.	Material	Finish	Used with connectors	Sales unit	RoHS
GT-BK(70)	751-0039-6 70	SPCC	Tin plating	GT5-1PP-HU(70), GT5-1PP-HU(A)(70), GT5-1PP-HU(B)(70) GT5-1PP-HU(C)(70), GT5-1PP-HU(D)(70) GT5-1PP-HU(E)(70), GT5-1PP-HU(F)(70) GT5-1PP-HU(G)(70), GT5-1PP-HU(H)(70) GT5-2/1PP-HU(70), GT5-2PP-HU(70) GT5-2PP-HU(A)(70), GT5-2PP-HU(B)(70) GT5-2PP-HU(C)(70)	1	○

## Crimping Tools

Please ask your Hirose Electric account representative for a user manual.

### Automatic Crimping Machine



Photo for reference only.  
Subject to change.

Part No. CM-105C

### Specifications

Item	Specifications	Remarks
Press capacity	1,5tons	
Stroke length	30mm	
Number of strokes	200spm (50Hz)	200spm (60Hz)
Weight	75kg	
Motor	0.2kW	AC100V
Crimping speed	2,000-4,000/H	

\*Terminal crimp height setting tables are available for each cable type. Please contact your Hirose Electric account representative.

Please note that we will need to define new crimp heights for novel cables and this may take a few days.

● **Harness Tools**

Contact Product No.	Contact HRS No.	Tool No.	Tool HRS No.
GT5-30/0,7-1,5PCF(70)	755-0017-9 70	AP105-GT5-30/0,7-1,5P	901-5021-8
GT5-30/0,7-1,5SCF(70)	755-0065-1 70	AP105-GT5-30/0,7-1,5S	901-5080-7
GT5L-2428/1,6-2,5PCF(70)	755-0079-6 70	AP105-GT5-2428/1,6-2,5P	901-5100-2
GT5-2428/1,6-2,5SCF(70)	755-0078-3 70	AP105-GT5-2428/1,6-2,5S	901-5101-5
GT5-30/1,6-2,9PCF(70)	755-0021-6 70	AP105-GT5-30/1,6-2,9P-ID	901-5019-6
		AP105-GT5-30/1,6-2,9P	901-5017-0
GT5-30/1,6-2,9SCF(70)	755-0022-9 70	AP105-GT5-30/1,6-2,9S-ID	901-5020-5
		AP105-GT5-30/1,6-2,9S	901-5018-3
GT5-2428/1,6-2,9PCF(70)	755-0001-9 70	AP105-GT5-2428/1,6-2,9P	901-5029-0
		AP105-GT5-2428/1,6-2,9PWS	901-5031-1
		AP105-GT5-2428/1,6-2,9P-B	901-5103-0
GT5-2428/1,6-2,9SCF(70)	755-0002-1 70	AP105-GT5-2428/1,6-2,9S	901-5030-9
		AP105-GT5-2428/1,6-2,9SWS	901-5032-4
		AP105-GT5-2428/1,6-2,9S-B	901-5104-3
GT5-2022/1,6-2,9SCF(70)	755-0071-4 70	AP105-GT5-2022/1,6-2,9S	901-5088-9
GT5-2022/F2,7-3,5PCF(70)	755-0076-8 70	AP105-GT5-2022/F2,7-3,5P	901-5091-3
GT5-2022/F2,7-3,5SCF(70)	755-0077-0 70	AP105-GT5-2022/F2,7-3,5S	901-5092-6
GT5-2022/F3,3-3,8PCF(70)	755-0053-2 70	AP105-GT5-2022/F3,3-3,8P	901-5075-7
GT5-2022/F3,3-3,8SCF(70)	755-0054-5 70	AP105-GT5-2022/F3,3-3,8S	901-5076-0
GT5-2022/F3,3-5PCF(70)	755-0033-5 70	AP105-GT5-2022/F3,3-5P-ID	901-5058-8
		AP105-GT5-2022/F3,3-5P	901-5059-0
GT5-2022/F3,3-5SCF(70)	755-0034-8 70	AP105-GT5-2022/F3,3-5S-ID	901-5060-0
		AP105-GT5-2022/F3,3-5S	901-5061-2
GT5-30/F4-5PCF(70)	755-0019-4 70	AP105-GT5-30/F4-5P-ID	901-5033-7
GT5-30/F4-5SCF(70)	755-0020-3 70	AP105-GT5-30/F4-5S-ID	901-5034-0
GT5-2428/F4-5PCF(70)	755-0023-1 70	AP105-GT5-2428/F4-5P-ID	901-5035-2
		AP105-GT5-2428/F4-5P-3C2V	901-5056-2
GT5-2428/F4-5SCF(70)	755-0024-4 70	AP105-GT5-2428/F4-5S-ID	901-5036-5
		AP105-GT5-2428/F4-5S-3C2V	901-5057-5
GT5-2022/F4-5PCF(70)	755-0035-0 70	AP105-GT5-2022/F4-5P	901-5052-1
		AP105-GT5-2022/F4-5P-18ID	901-5121-2
GT5-2022/F4-5SCF(70)	755-0036-3 70	AP105-GT5-2022/F4-5S	901-5053-4
		AP105-GT5-2022/F4-5S-18ID	901-5102-8
G-1,6PCF(70)	755-0029-8 70	AP105-G-1,6P	901-5041-5
GTA-0,7CF	755-0074-2	AP105-GTA,B-0,7P	901-5141-0
GTB-0,7CF	755-0075-5	AP105-GTA,B-0,7P	901-5141-0
GTA-1,6CF(70)	755-0032-2 70	AP105-GTA,B-1,6P	901-5047-1
GTB-1,6CF(70)	755-0049-5 70	AP105-GTA,B-1,6P	901-5047-1
GTC-1,6CF	755-0106-7	AP105-GTA,B-1,6P	901-5047-1
GTE-3,7CF	755-0122-3	AP105-GTE-3,7	901-5151-3

**Please refer to our cable termination procedure manual for performing terminations.**

GT5  
GT13  
GT16  
GT19  
GT22  
GT24  
GT25  
GT26  
GT27  
GT28  
GT29  
GT30  
GT31  
GT32  
GT33  
GT34  
GT35  
GT36  
GT37  
GT38  
GT39  
GT40  
GT41  
GT42  
GT43  
GT44  
GT45  
GT46  
GT47  
GT48  
GT49  
GT50  
GT51  
GT52  
GT53  
GT54  
GT55  
GT56  
GT57  
GT58  
GT59  
GT60  
GT61  
GT62  
GT63  
GT64  
GT65  
FH40  
FH41  
FH42  
FH43  
FH44  
FH45  
FH46  
FH47  
FH48  
FH49  
FH50  
FH51  
FH52  
FH53  
FH54  
FH55  
FH56  
FH57  
FH58  
FH59  
FH60  
FH61  
FH62  
FH63  
FH64  
FH65  
FH66  
FH67

## X-ON Electronics

Largest Supplier of Electrical and Electronic Components

*Click to view similar products for [Automotive Connectors](#) category:*

*Click to view products by [Hirose](#) manufacturer:*

Other Similar products are found below :

[003-018-000](#) [60403001](#) [60993906-B](#) [M902-2131](#) [M902-2161](#) [72.330.1035.1](#) [73.353.4028.0](#) [F119300-B](#) [F166900](#) [F258300-B](#) [F358300-B](#)  
[F407400](#) [F444110](#) [F487000](#) [F509500B-B](#) [827153-1](#) [8N1515-32-24P](#) [9-1326729-8](#) [925474-1](#) [928905-1](#) [964562-4](#) [968782-1](#) [GT17SA-8DS-](#)  
[HU](#) [98891-1012](#) [98947-1016](#) [12004475-L](#) [12010290](#) [12010309-B](#) [12015454](#) [12020219-B](#) [12020308](#) [12041318-B](#) [12052225-L](#) [12052466](#)  
[12059125](#) [12064869](#) [12004327-B](#) [12010503-B](#) [12015308](#) [12015384](#) [12015909](#) [1-21030-1](#) [12041254](#) [12041318](#) [12047946-B](#) [12047957](#)  
[12047957-L](#) [12059473](#) [12066261](#) [12110546](#)