

# GT5 Series

— Connectors for Coaxial Cables —

(In-line type, Board type, Hybrid type, Waterproof type)

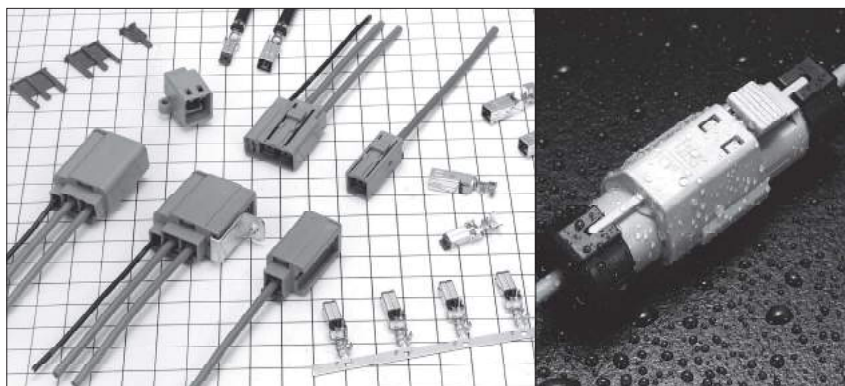

## ■ Features

### ● Cost performance:

Labor costs can be kept low because signal wires and shield wires can be crimped in one step. Additionally, the cable assembly process is semi-automatic.

### ● Excellent high frequency performance

Please refer to V.S.W.R data on the following pages.

## ■ Applications

For car TV, radio antenna, etc.

## ◆ TEST DATA (using 1.5D-2V Type cable)

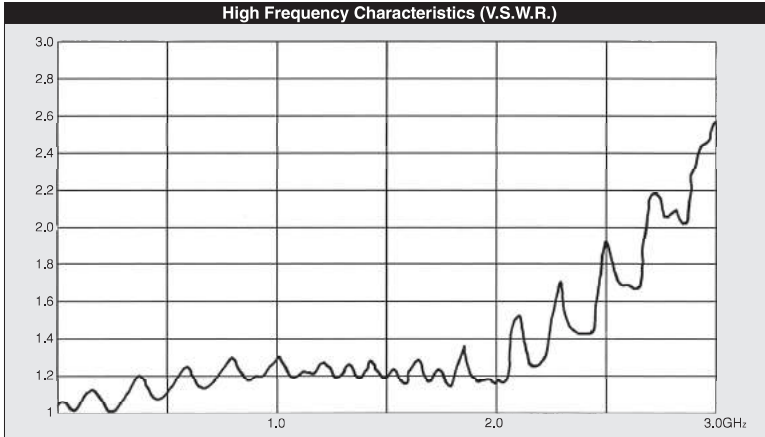

(Note) The above measurement data is for GT5-1S-HU and GT5-1PP-HU.

## ◆ Cable Assembly Instructions

1. Strip the cable.

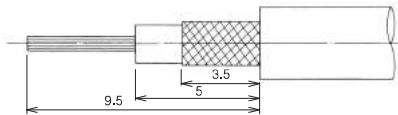

3. Insert the terminal into the housing. (Push it in until the housing lance latches.)

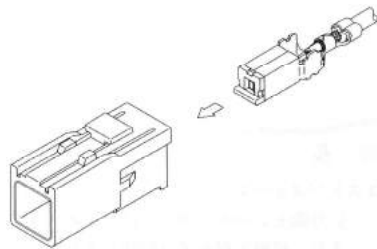

2. Crimp the cable to the terminal.

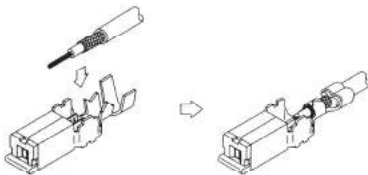

4. Attach the retainer (Push in the retainer until it locks.)

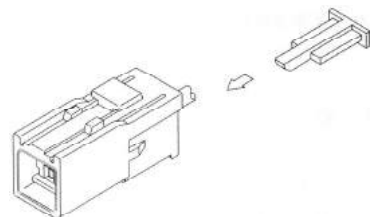

## Terminal for Coaxial Cable

### F Connector Terminals

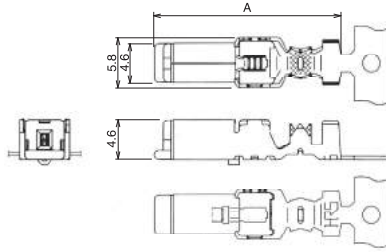

Part No.	HRS No.	Material / Finish or color	Conductor size	Insulator outer diameter	Jacket outer diameter	A	Sales unit	RoHS
GT5-30/0.7-1.5SCF(70)	755-0065-1 70	Insulator : PBT/Dark gray Center terminal : Phosphor bronze/Tin plating Outer terminal : Brass/Tin plating	AWG#30	φ0.6~0.9	φ1.4~1.8	22.7	1,300pcs/reel	○
GT5-2428/1.1-2.2SCF	755-0123-6		AWG#24~28	φ1.0~1.4	φ2.0~2.4	21.7		
GT5-2428/1.6-2.5SCF(70)	755-0078-3 70			φ2.3~2.7	φ2.6~3.4			
GT5-30/1.6-2.9SCF(70)	755-0022-9 70		AWG#30	φ1.5~2.0		φ2.6~3.4		
GT5-2428/1.6-2.9SCF(70)	755-0002-1 70		AWG#24~28					
GT5-2022/1.6-2.9SCF(70)	755-0071-4 70		AWG#20~22	φ2.0~2.5	φ3.3~3.7	22.7		
GT5-2022/F2.7-3.5SCF(70)	755-0077-0 70							
* GT5-2022/F3.3-3.8SCF(70)	755-0054-5 70		AWG#30	φ2.5~2.9	φ4.6~5.0	1,100pcs/reel		
* GT5-30/F3.3-5SCF(70)	755-0016-6 70							
* GT5-2428/F3.3-5SCF(70)	755-0012-5 70		AWG#20~22	φ3.0~3.6	AWG#30			
* GT5-2022/F3.3-5SCF(70)	755-0034-8 70	AWG#24~28						
GT5-30/F4-5SCF(70)	755-0020-3 70		AWG#20~22	AWG#30				
* GT5-2428/F4-5SCF(70)	755-0024-4 70	AWG#24~28						
* GT5-2022/F4-5SCF(70)	755-0036-3 70		AWG#20~22	AWG#30				

Note : Products marked with an asterisk (\*) support insulators made of polyethylene foam.

### M Connector Terminals

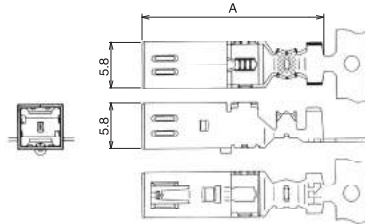

Part No.	HRS No.	Material / Finish or color	Conductor size	Insulator outer diameter	Jacket outer diameter	A	Sales unit	RoHS
GT5-30/0.7-1.5PCF(70)	755-0017-9 70	Insulator : PBT/Dark gray Center terminal : Brass/Tin plating Outer terminal : Brass/Tin plating	AWG#30	φ0.6~0.9	φ1.4~1.8	24.05	900pcs/reel	○
GT5-30/1.6-2.9PCF(70)	755-0021-6 70		AWG#24~28	φ1.5~2.0	φ2.6~3.4	23.05		
GT5-2428/1.6-2.9PCF(70)	755-0001-9 70		AWG#20~22					
GT5-2022/1.6-2.9PCF(70)	755-0094-0 70			φ2.5~2.9	φ3.6~4.0			
GT5-2022/F2.7-3.5PCF(70)	755-0076-8 70		AWG#30			φ2.5~2.9		
* GT5-2022/F3.3-3.8PCF(70)	755-0053-2 70			AWG#24~28				
* GT5-30/F3.3-5PCF(70)	755-0015-3 70		AWG#20~22		AWG#30			
* GT5-2428/F3.3-5PCF(70)	755-0011-2 70			AWG#24~28				
* GT5-2022/F3.3-5PCF(70)	755-0033-5 70		AWG#30		φ3.0~3.6			
* GT5-30/F4-5PCF(70)	755-0019-4 70			AWG#24~28				
* GT5-2428/F4-5PCF(70)	755-0023-1 70	AWG#20~22	AWG#30					
* GT5-2022/F4-5PCF(70)	755-0035-0 70			AWG#24~28				

Note : Products marked with an asterisk (\*) support insulators made of polyethylene foam.

### Terminal for Low-insertion M Connector

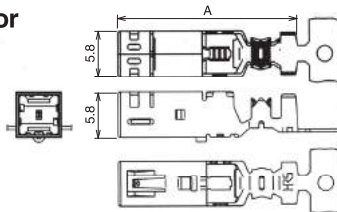

Part No.	HRS No.	Material / Finish or color	Conductor size	Insulator outer diameter	Jacket outer diameter	A	Sales unit	RoHS
GT5L30/0.7-1.5PCF(70)	755-0068-0 70	Insulator : PBT/Dark gray Center terminal : Brass/Tin plating Outer terminal : Brass/Tin plating	AWG#30	φ0.6~0.9	φ1.4~1.8	24.05	900pcs/reel	○
GT5L-2428/1.6-2.5PCF(70)	755-0079-6 70		AWG#24~28					
GT5L30/1.6-2.9PCF(70)	755-0067-7 70		AWG#30	φ2.6~3.4				
GT5L-2428/1.6-2.9PCF(70)	755-0066-4 70		AWG#24~28					

GT5  
GT13  
GT16  
GT19  
GT21  
GT36  
GT43  
GT17  
GT32  
GT25  
KM37  
ZE05  
ZG05J2  
HM-200  
ZE64W  
T307U  
FK26  
DE40  
DE40GL  
FH28K  
FH2K  
FH65  
FH40  
FH63S  
FH67

**1 Pos. for Coaxial Cable**

**F Connector**

● **Housing**



GT5-1S-HU

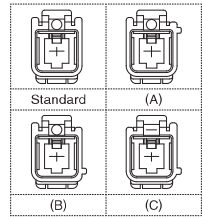
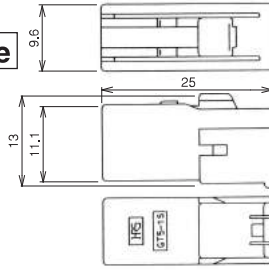

◆ **Shown with retainer inserted.**

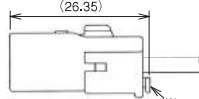

\*Use together with separate retainer (GT5-1P/S-R) sold separately.

Part No.	HRS No.	Material	Color	Key position	Corresponding M Connector Housing	Corresponding M Connector Board-Mounting	Sales unit	RoHS
GT5-1S-HU	755-0004-7	PBT	Light gray	Standard	GT5-1PP-HU(70)	GT5-1P-DS(70)	1	○
GT5-1S-HU(A)	755-0037-6		Brown	(A)	GT5-1PP-HU(A)(70)	GT5-1P-DS(A)(70)		
GT5-1S-HU(B)	755-0038-9		Green	(B)	GT5-1PP-HU(B)(70)	GT5-1P-DS(B)(70)		
GT5-1S-HU(C)	755-0080-5		Blue	(C)	GT5-1PP-HU(C)(70)	GT5-1P-DS(C)(70)		

\*M connector mating table (Use types with matching key positions as described above.)

● **Retainer (Used with: GT5-1S-HU, GT5-1PP-HU, GT5N-1PP-HU, GT5H-1PP-HU)**



Part No.	HRS No.	Material	Color	Sales unit	RoHS
GT5-1P/S-R	755-0006-2	PBT	Dark gray	1	○

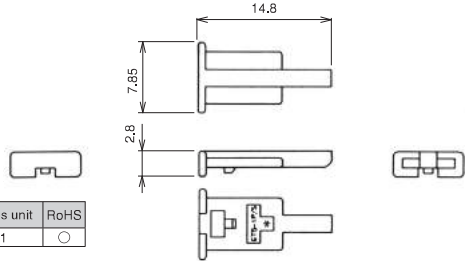

● **Housing (Retainer Not Required)**



GT5R-1S-HU

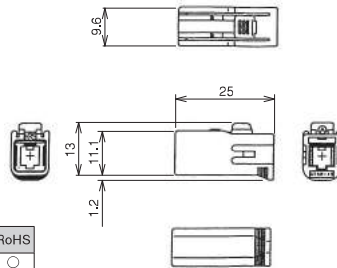

Part No.	HRS No.	Material	Color	Sales unit	RoHS
GT5R-1S-HU	755-0047-0	PBT	Light gray	1	○

Dec. 1. 2021 HIROSE ELECTRIC CO., LTD. All Rights Reserved.

Dec. 1, 2021, Copyright 2021 HIROSE ELECTRIC CO., LTD., All Rights Reserved. GT5 GT13 GT16 GT19 FH65 FH40 FH35 FH67

## M Connector

### ● Housing

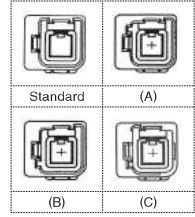
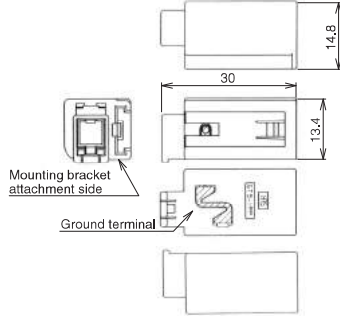

### ◆ Shown with retainer inserted.

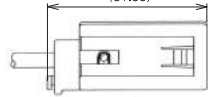

\*Use together with separate retainer (GT5-1P/S-R) sold separately.

Part No.	HRS No.	Corresponding F Connector Housing	Material / Finish	Color	Key position	Sales unit	RoHS
GT5-1PP-HU(70)	755-0005-0 70	GT5-1S-HU	Housing: PBT	Light gray	Standard	1	○
GT5-1PP-HU(A)(70)	755-0039-1 70	GT5-1S-HU (A)	Ground terminal: Phosphor bronze/Tin plating	Brown (A)	(A)		
GT5-1PP-HU(B)(70)	755-0040-0 70	GT5-1S-HU (B)		Green (B)	(B)		
GT5-1PP-HU(C)(70)	755-0103-9 70	GT5-1S-HU (C)		Blue (C)	(C)		

\*See page 17 for panel mounting in-line bracket.

\*Please use a corresponding F connector housing with a matching key type.

### ● Housing (H type bracket)

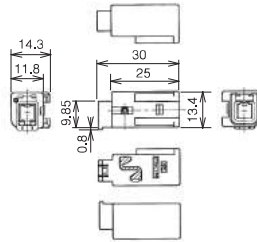

### ◆ Mated Connector

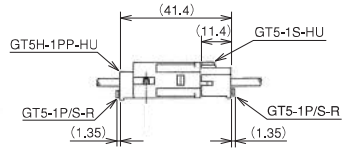

\*Use together with separate retainer (GT5-1P/S-R) sold separately.

Part No.	HRS No.	Material	Color	Corresponding F Connector	Sales unit	RoHS
GT5H-1PP-HU(10)	755-0093-7 10	PBT	Light gray	GT5-1S-HU GT5R-1S-HU	1	○

### ● Housing (N type bracket)

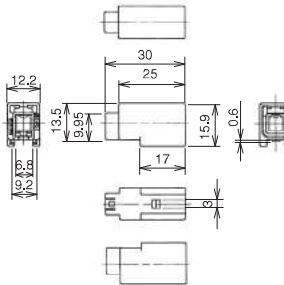
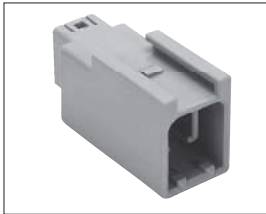

### ◆ Mated Connector

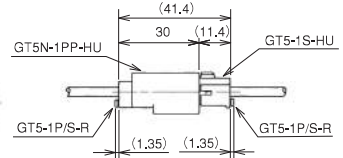

\*Use together with separate retainer (GT5-1P/S-R) sold separately.

Part No.	HRS No.	Material	Color	Corresponding F Connector	Sales unit	RoHS
GT5N-1PP-HU	755-0090-9	PBT	Light gray	GT5-1S-HU GT5R-1S-HU	1	○

GT5  
GT13  
GT16  
GT19  
GT21  
GT36  
GT43  
GT17  
GT32  
GT25  
KM37  
ZE05  
ZG05L2  
HM-H-200  
ZE664W  
H2031L  
FX26  
DF40  
DF40GL  
FH28K  
FH52K  
FH65  
FH40  
FH63S  
FH67

● Housing

〔 Panel Mount type  
Enforced Shield type 〕

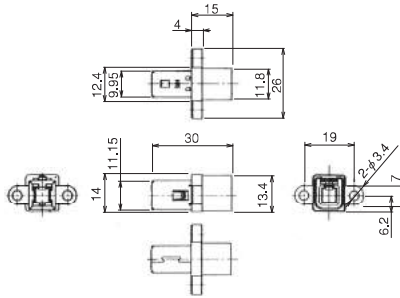

◆ Recommended Panel Dimensions

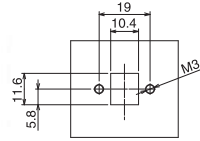

◆ Mated Connector

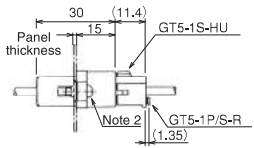

Part No.	HRS No.	Material / Finish or color	Corresponding F Connector	Sales unit	RoHS
GT5A-1PP-HU(70)	755-0025-7 70	Housing : PBT/ Light gray Ground terminal : Brass/Tin plating	GT5-1S-HU GT5R-1S-HU	1	○

Note 1 : This product does not require a retainer.

Note 2 : Use M3 screws listed in JIS B 1111 and 1101 M3 screws for mounting screws.

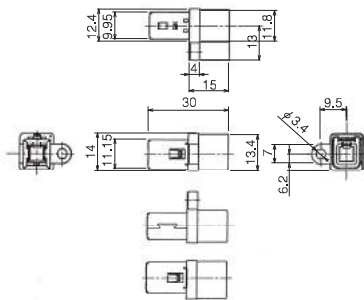

◆ Recommended Panel Dimensions

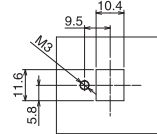

Part No.	HRS No.	Material / Finish or color	Corresponding F Connector	Sales unit	RoHS
GT5P-1PP-HU(70)	755-0030-7 70	Housing : PBT/ Light gray Ground terminal : Brass/Tin plating	GT5-1S-HU GT5R-1S-HU	1	○

Note 1 : This product does not require a retainer.

Note 2 : Use M3 screws listed in JIS B 1111 and 1101 M3 screws for mounting screws.

Dec. 1, 2021 Copyright 2021 HIROSE ELECTRIC CO., LTD., All Rights Reserved. GT5 GT13 GT16 GT19 FH65 FH40 FH35 FH67

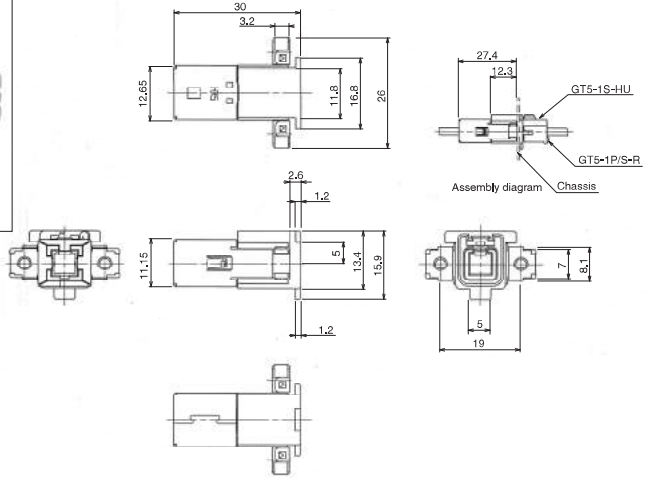

Part No.	HRS No.	Material / Finish or color	Corresponding F Connector	Sales unit	RoHS
GT5B-1PP-HU(70)	755-0051-7 70	Housing : PBT/ Light gray Ground terminal : Phosphor bronze/Tin plating	GT5-1S-HU GT5R-1S-HU	1	○

Note 1 : This product does not require a retainer.

Note 2 : Use JIS B 1115 and 1122 class 4, nominal diameter 3, length 6 screws for the mounting screws.

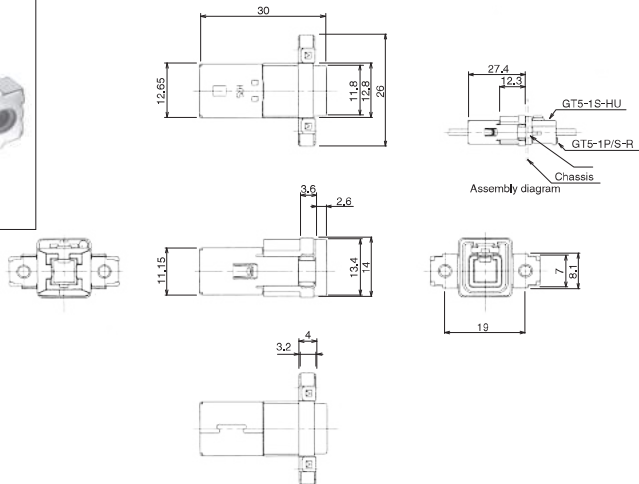

Part No.	HRS No.	Material / Finish or color	Corresponding F Connector	Sales unit	RoHS
GT5S-1PP-HU(70)	755-0050-4 70	Housing : PBT/ Light gray Ground terminal : Phosphor bronze/Tin plating	GT5-1S-HU GT5R-1S-HU	1	○

Note 1 : This product does not require a retainer.

Note 2 : Use JIS B 1115 and 1122 class 4, nominal diameter 3, length 6 screws for the mounting screws.

GT5  
GT13  
GT16  
GT19  
GT21  
GT36  
GT43  
GT17  
GT32  
GT25  
KM37  
ZE05  
Z09012  
HM5-200  
Z0604W  
H2071L  
FX26  
DF40  
DF40GL  
FH28K  
FH2K  
FH65  
FH40  
FH63S  
FH67

● Board Mount type

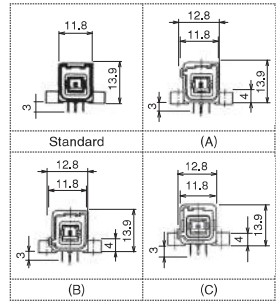
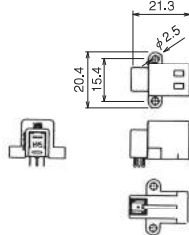

◆ Mated Connector

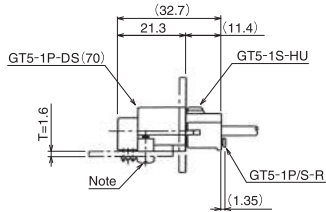

◆ Recommended Board Dimensions

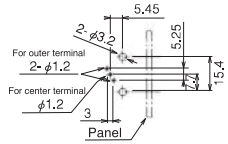

Part No.	HRS No.	Material / Finish or color	Color	Key position	Corresponding connector	Sales unit	RoHS
GT5-1P-DS(70)	755-0007-5 70	Housing: PBT	Light gray	Standard	GT5-1S-HU	1	○
GT5-1P-DS(A)(70)	755-0041-3 70	Center terminal: Brass/Tin plating	Brown	(A)	GT5-1S-HU(A)		
GT5-1P-DS(B)(70)	755-0042-6 70	Insulator: PBT/Dark gray	Green	(B)	GT5-1S-HU(B)		
GT5-1P-DS(C)(70)	755-0083-3 70	Outer terminal: Phosphor bronze/Tin plating	Blue	(C)	GT5-1S-HU(C)		

Note : Use JIS B 1115 and 1122 class 4, nominal diameter 3, length 6 screws (for a board thickness of 1.6 mm) for the mounting screws.  
 \*Six types of keys are available.  
 Please use a corresponding F connector housing with a matching key type.

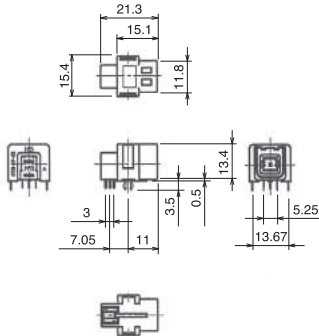

◆ Mated Connector

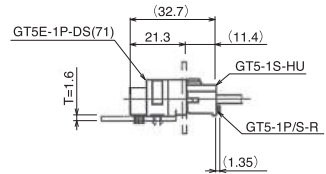

◆ Recommended Board Dimensions

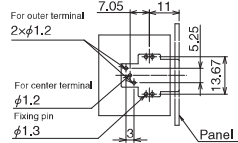

Part No.	HRS No.	Material / Finish or color	Corresponding connector	Sales unit	RoHS
GT5E-1P-DS(71)	755-0125-1 71	Housing: PA/ Natural Center terminal: Brass/Tin plating Insulator: PA/Black Outer terminal: Phosphor bronze/Tin plating Fixing pin: Brass/ Tin plating	GT5-1S-HU GT5R-1S-HU	1	○



# 1 Pos. for Coaxial Cable, Waterproof type

## F Connector

### ● Housing

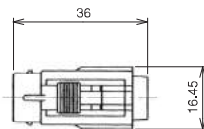

Part No.	HRS No.	Material	Color	Sales unit	RoHS
GT5W-1S-HU	755-0027-2	PBT	Light gray	1	○

Note : Use this product with a retainer that matches the cable.

### ● Retainer (Used with: GT5W-1PP-HU, GT5JW-1PP-HU, GT5W-1S-HU, GT5W-1P-HU)

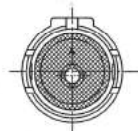
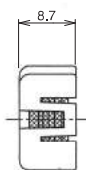
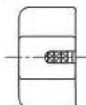
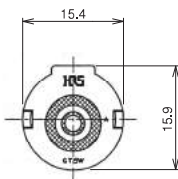

Part No.	HRS No.	Material / Finish or color	Sales unit	RoHS
GT5W-1P/S-R	755-0028-5	Retainer : PBT/Dark gray Rubber : Silicon rubber/Light blue	1	○

\*This product supports cables with outer diameters of  $\phi 2.9$  to  $\phi 3.4$ .  
Waterproofness will depend on the cable. Please contact Hirose Electric if you intend to use cables other than those recommended.

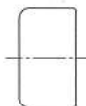

GT5  
GT13  
GT16  
GT19  
GT21  
GT36  
GT43  
GT17  
GT32  
GT25  
KM37  
ZE05  
ZG0512  
HM-H-200  
ZE644W  
H2071L  
FX26  
DE40  
DE40GL  
FH28K  
FH2K  
FH65  
FH40  
FH63  
FH67

## M Connector

### Housing

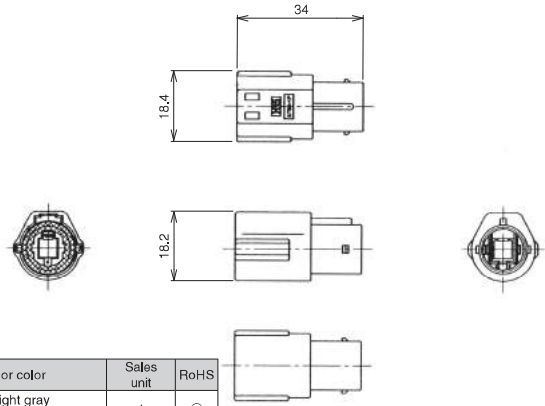

Part No.	HRS No.	Material / Finish or color	Sales unit	RoHS
GT5W-1P-HU	755-0026-0	Housing : PBT/ Light gray Connector seal : Silicon rubber/White	1	○

Note : Use this product with a retainer that matches the cable.

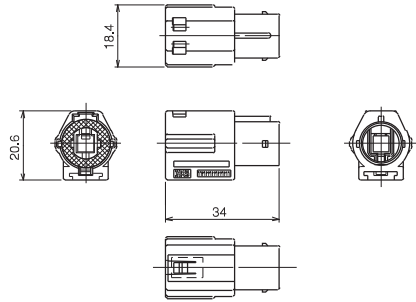

### Recommended Bracket Dimensions (Used with GT5W-1PP-HU)

Please check with Hirose for information on the bracket for GT5JW-1PP-HU.

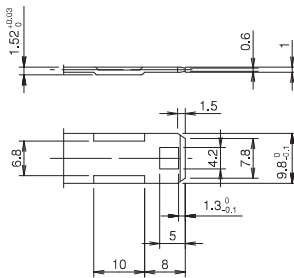

Part No.	HRS No.	Material / Finish or color	Sales unit	RoHS
GT5W-1PP-HU	755-0070-1	Housing : PBT/ Light gray	1	○
GT5JW-1PP-HU	755-0069-2	Connector seal : Silicon rubber/White		

Note : Use this product with a retainer that matches the cable.

### Mated Connector

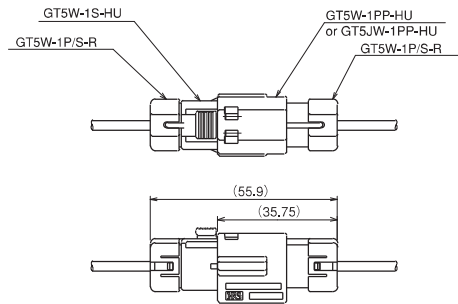

# G Terminal

## ■ For Cable Termination Part

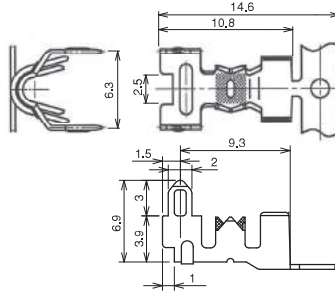
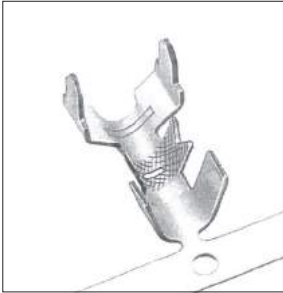

### ◆ Recommended Cable Assembly Diagram

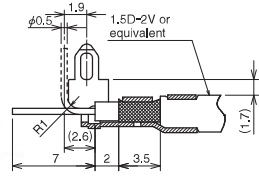

### ◆ Recommended Board Dimensions

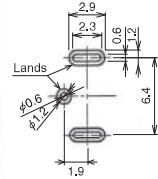

Part No.	HRS No.	Material	Finish	Sales unit	RoHS
GTA-1.6CF(70)	755-0032-2 70	Brass	Tin plating	1,500 pcs/reel	○

## ◆ Recommended Cable Assembly Diagram

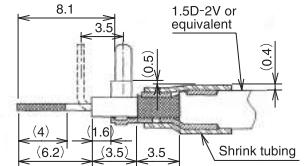
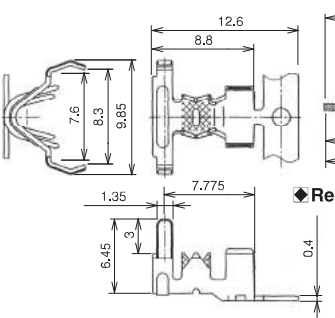
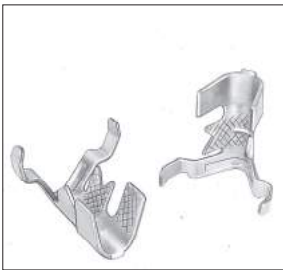

### ◆ Recommended Board Dimensions

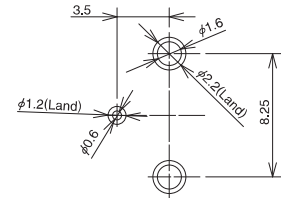

Part No.	HRS No.	Material	Finish	Sales unit	RoHS
GTB-1.6CF(70)	755-0049-5 70	Brass	Tin plating	1,500 pcs/reel	○

## ◆ Recommended Cable Assembly Diagram

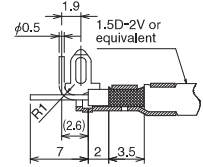
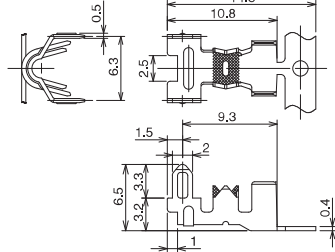

### ◆ Recommended Board Dimensions

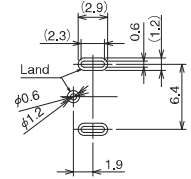

Part No.	HRS No.	Material	Finish	Sales unit	RoHS
GTG-1.6CF	755-0106-7	Brass	Tin plating	1,500 pcs/reel	○

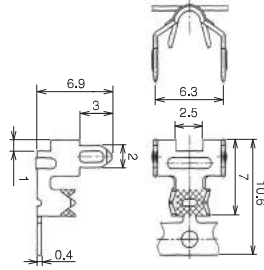
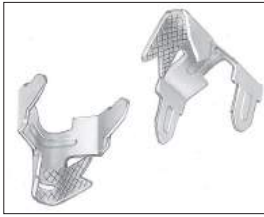

Part No.	HRS No.	Material	Finish	Sales unit	RoHS
G-1.6PCF(70)	755-0029-8 70	Brass	Tin plating	1,500 pcs/reel	○

◆ Recommended Cable Assembly Diagram

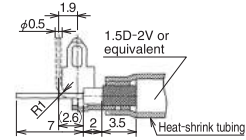

◆ Recommended Board Dimensions

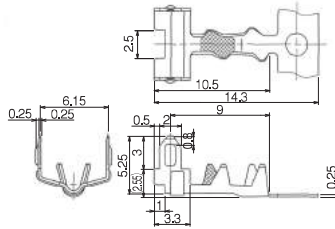
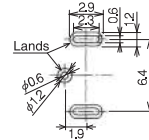

Part No.	HRS No.	Material	Finish	Sales unit	RoHS
GTA-0.7CF	755-0074-2	Brass	Tin plating	1,500 pcs/reel	○

◆ Recommended Cable Assembly Diagram

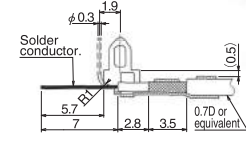

◆ Recommended Board Dimensions

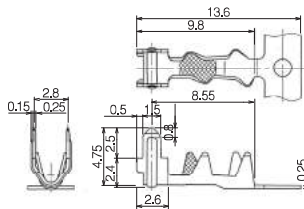
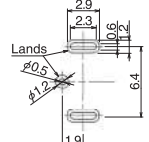

Part No.	HRS No.	Material	Finish	Sales unit	RoHS
GTB-0.7CF	755-0075-5	Brass	Tin plating	1,500 pcs/reel	○

◆ Recommended Cable Assembly Diagram

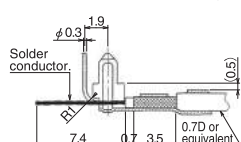

◆ Recommended Board Dimensions

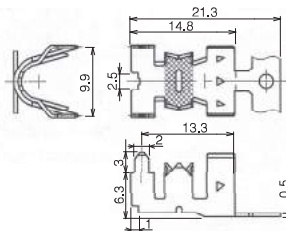
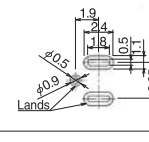

Part No.	HRS No.	Material	Finish	Sales unit	RoHS
GTE-3.7CF	755-0122-3	Brass	Tin plating	1,100 pcs/reel	○

◆ Recommended Cable Assembly Diagram

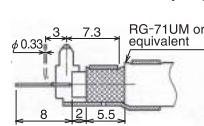

◆ Recommended Board Dimensions

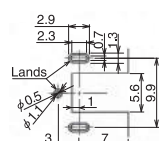

GT5 GT13 GT16 GT19 GT21  
 Dec. 1, 2021 Copyright 2021 HIROSE ELECTRIC CO., LTD. All Rights Reserved.  
 FH65 FH40 FH35 FH27

## Shield Plate

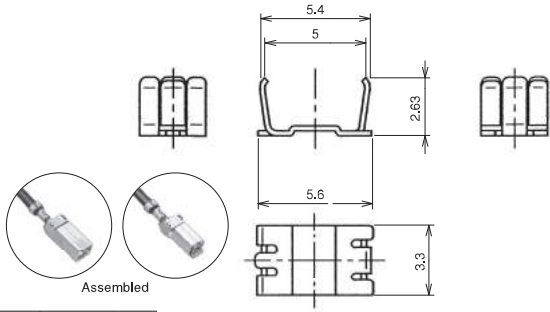

Part No.	HRS No.	Material	Finish	Sales unit	RoHS
GT5C-1P/S-CSB(70)	755-0048-2 70	Brass	Tin plating	1	○

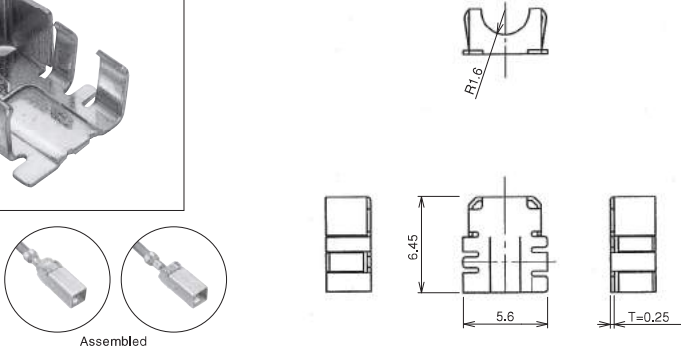
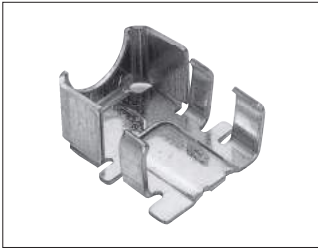

Part No.	HRS No.	Material	Finish	Sales unit	RoHS
GT5C-1P/S-CSB(70)	755-0088-7 70	Brass	Tin plating	1	○

## Panel Mount In-line Bracket

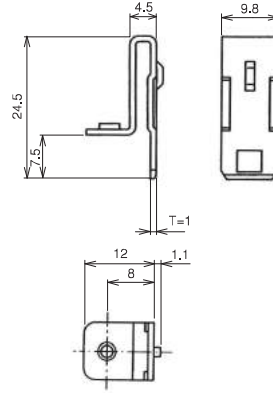

Part No.	HRS No.	Material	Finish	Used with connectors	Sales unit	RoHS
GT-BK(70)	751-0039-6 70	SPCC	Tin plating	GT5-1PP-HU(70), GT5-1PP-HU(A)(70), GT5-1PP-HU(B)(70) GT5-1PP-HU(C)(70), GT5-1PP-HU(D)(70) GT5-1PP-HU(E)(70), GT5-1PP-HU(F)(70) GT5-1PP-HU(G)(70), GT5-1PP-HU(H)(70) GT5-2/1PP-HU(70), GT5-2PP-HU(70) GT5-2PP-HU(A)(70), GT5-2PP-HU(B)(70) GT5-2PP-HU(C)(70)	1	○

## Crimping Tools

Please ask your Hirose Electric account representative for a user manual.

### Automatic Crimping Machine



Photo for reference only.  
Subject to change.

Part No. CM-105C

### Specifications

Item	Specifications	Remarks
Press capacity	1,5tons	
Stroke length	30mm	
Number of strokes	200spm (50Hz)	200spm (60Hz)
Weight	75kg	
Motor	0.2kW	AC100V
Crimping speed	2,000-4,000/H	

\*Terminal crimp height setting tables are available for each cable type. Please contact your Hirose Electric account representative.

Please note that we will need to define new crimp heights for novel cables and this may take a few days.

● **Harness Tools**

Contact Product No.	Contact HRS No.	Tool No.	Tool HRS No.
GT5-30/0,7-1,5PCF(70)	755-0017-9 70	AP105-GT5-30/0,7-1,5P	901-5021-8
GT5-30/0,7-1,5SCF(70)	755-0065-1 70	AP105-GT5-30/0,7-1,5S	901-5080-7
GT5L-2428/1,6-2,5PCF(70)	755-0079-6 70	AP105-GT5-2428/1,6-2,5P	901-5100-2
GT5-2428/1,6-2,5SCF(70)	755-0078-3 70	AP105-GT5-2428/1,6-2,5S	901-5101-5
GT5-30/1,6-2,9PCF(70)	755-0021-6 70	AP105-GT5-30/1,6-2,9P-ID	901-5019-6
		AP105-GT5-30/1,6-2,9P	901-5017-0
GT5-30/1,6-2,9SCF(70)	755-0022-9 70	AP105-GT5-30/1,6-2,9S-ID	901-5020-5
		AP105-GT5-30/1,6-2,9S	901-5018-3
GT5-2428/1,6-2,9PCF(70)	755-0001-9 70	AP105-GT5-2428/1,6-2,9P	901-5029-0
		AP105-GT5-2428/1,6-2,9PWS	901-5031-1
		AP105-GT5-2428/1,6-2,9P-B	901-5103-0
GT5-2428/1,6-2,9SCF(70)	755-0002-1 70	AP105-GT5-2428/1,6-2,9S	901-5030-9
		AP105-GT5-2428/1,6-2,9SWS	901-5032-4
		AP105-GT5-2428/1,6-2,9S-B	901-5104-3
GT5-2022/1,6-2,9SCF(70)	755-0071-4 70	AP105-GT5-2022/1,6-2,9S	901-5088-9
GT5-2022/F2,7-3,5PCF(70)	755-0076-8 70	AP105-GT5-2022/F2,7-3,5P	901-5091-3
GT5-2022/F2,7-3,5SCF(70)	755-0077-0 70	AP105-GT5-2022/F2,7-3,5S	901-5092-6
GT5-2022/F3,3-3,8PCF(70)	755-0053-2 70	AP105-GT5-2022/F3,3-3,8P	901-5075-7
GT5-2022/F3,3-3,8SCF(70)	755-0054-5 70	AP105-GT5-2022/F3,3-3,8S	901-5076-0
GT5-2022/F3,3-5PCF(70)	755-0033-5 70	AP105-GT5-2022/F3,3-5P-ID	901-5058-8
		AP105-GT5-2022/F3,3-5P	901-5059-9
GT5-2022/F3,3-5SCF(70)	755-0034-8 70	AP105-GT5-2022/F3,3-5S-ID	901-5060-0
		AP105-GT5-2022/F3,3-5S	901-5061-2
GT5-30/F4-5PCF(70)	755-0019-4 70	AP105-GT5-30/F4-5P-ID	901-5033-7
GT5-30/F4-5SCF(70)	755-0020-3 70	AP105-GT5-30/F4-5S-ID	901-5034-0
GT5-2428/F4-5PCF(70)	755-0023-1 70	AP105-GT5-2428/F4-5P-ID	901-5035-2
		AP105-GT5-2428/F4-5P-3C2V	901-5056-2
GT5-2428/F4-5SCF(70)	755-0024-4 70	AP105-GT5-2428/F4-5S-ID	901-5036-5
		AP105-GT5-2428/F4-5S-3C2V	901-5057-5
GT5-2022/F4-5PCF(70)	755-0035-0 70	AP105-GT5-2022/F4-5P	901-5052-1
		AP105-GT5-2022/F4-5P-18ID	901-5121-2
GT5-2022/F4-5SCF(70)	755-0036-3 70	AP105-GT5-2022/F4-5S	901-5053-4
		AP105-GT5-2022/F4-5S-18ID	901-5102-8
G-1,6PCF(70)	755-0029-8 70	AP105-G-1,6P	901-5041-5
GTA-0,7CF	755-0074-2	AP105-GTA,B-0,7P	901-5141-0
GTB-0,7CF	755-0075-5	AP105-GTA,B-0,7P	901-5141-0
GTA-1,6CF(70)	755-0032-2 70	AP105-GTA,B-1,6P	901-5047-1
GTB-1,6CF(70)	755-0049-5 70	AP105-GTA,B-1,6P	901-5047-1
GTC-1,6CF	755-0106-7	AP105-GTA,B-1,6P	901-5047-1
GTE-3,7CF	755-0122-3	AP105-GTE-3,7	901-5151-3

**Please refer to our cable termination procedure manual for performing terminations.**

GT5 GT13 GT16 GT19 GT22 GT25 GT28 GT31 GT34 GT37 GT40 GT43 GT46 GT49 GT52 GT55 GT58 GT61 GT64 GT67 GT69 GT72 GT75 GT78 GT81 GT84 GT87 GT90 GT93 GT96 GT99 FH65 FH40 FH35 FH67

Dec. 1, 2021. Copyright 2021 HIROSE ELECTRIC CO., LTD. All Rights Reserved.

## X-ON Electronics

Largest Supplier of Electrical and Electronic Components

*Click to view similar products for [Automotive Connectors](#) category:*

*Click to view products by [Hirose](#) manufacturer:*

Other Similar products are found below :

[003-018-000](#) [60403001](#) [60993906-B](#) [M902-2131](#) [M902-2161](#) [72.330.1035.1](#) [73.353.4028.0](#) [F119300-B](#) [F166900](#) [F258300-B](#) [F358300-B](#)  
[F407400](#) [F444110](#) [F487000](#) [F509500B-B](#) [827153-1](#) [8N1515-32-24P](#) [9-1326729-8](#) [925474-1](#) [928905-1](#) [964562-4](#) [968782-1](#) [GT17SA-8DS-](#)  
[HU](#) [98891-1012](#) [98947-1016](#) [12004475-L](#) [12010290](#) [12010309-B](#) [12015454](#) [12020219-B](#) [12020308](#) [12041318-B](#) [12052225-L](#) [12052466](#)  
[12059125](#) [12064869](#) [12004327-B](#) [12010503-B](#) [12015308](#) [12015384](#) [12015909](#) [1-21030-1](#) [12041254](#) [12041318](#) [12047946-B](#) [12047957](#)  
[12047957-L](#) [12059473](#) [12066261](#) [12110546](#)