

ELV, RoHS COMPLIANT

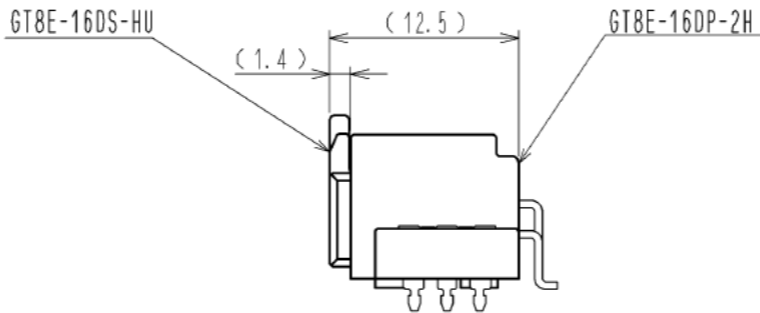

MATED CONNECTORS

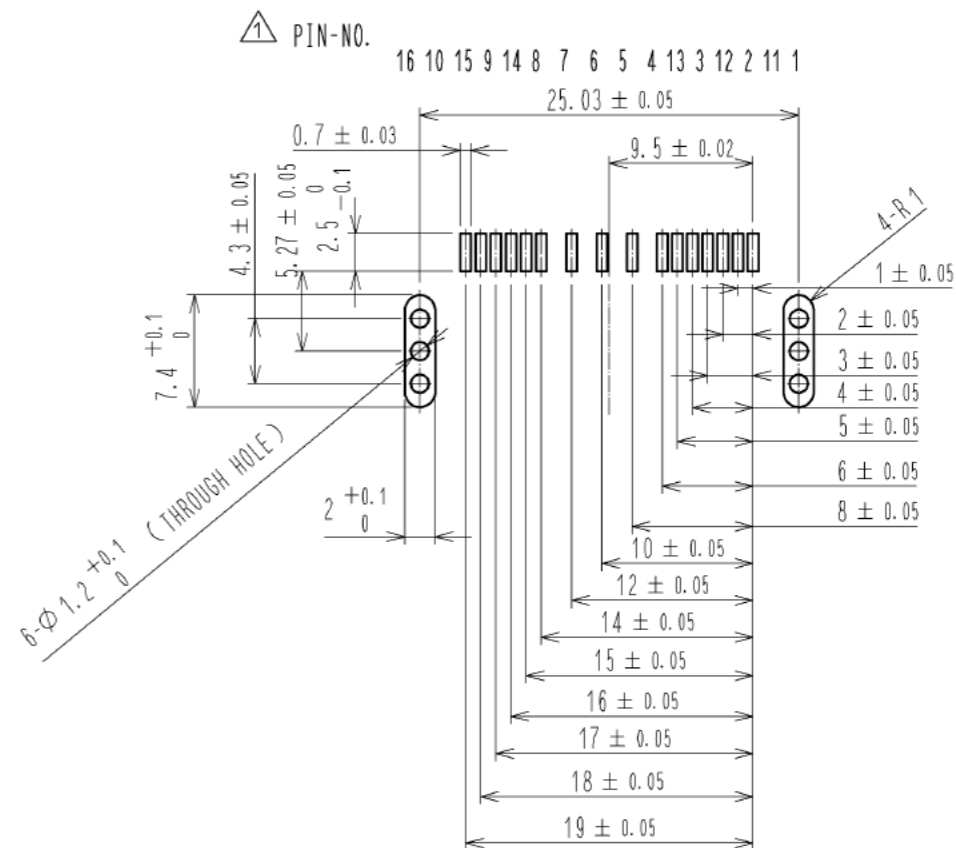

RECOMMENDED PC BOARD PATTERN (CONNECTOR SIDE)

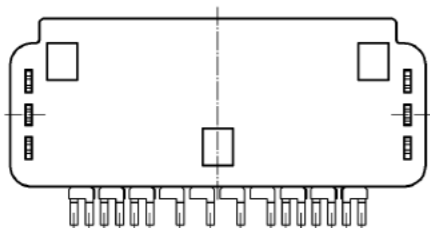
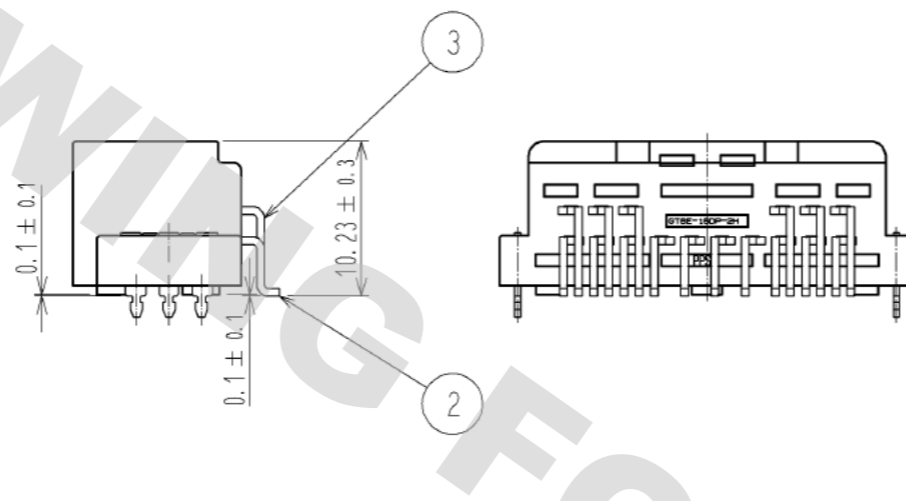
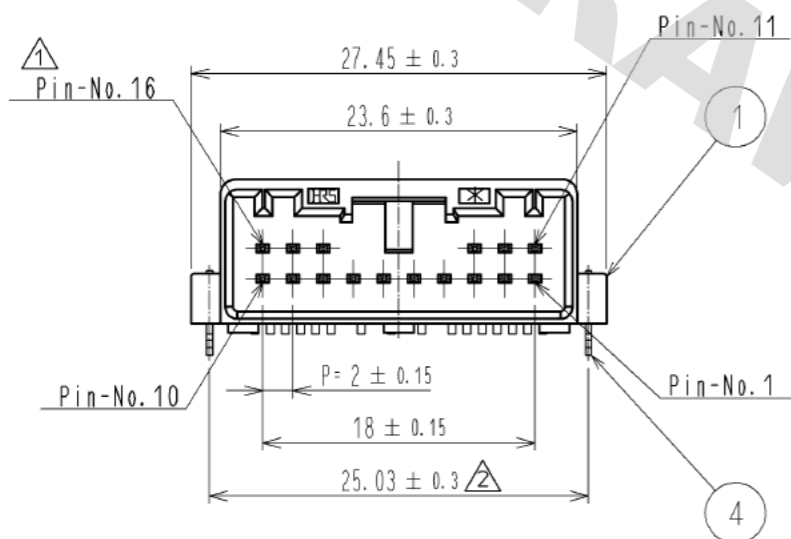

NOTE 1. RECOMMENDED REFLOW TEMPERATURE PROFILE (REFER RIGHT FIG.).

REFLOW HEATING: FAR-INFLARED, IN THE AIR OR NITROGEN

NUMBER OF REFLOW CYCLES: 2 CYCLES MAX

PEAK TEMPERATURE: 250°C

ABOVE 230°C: 20~40s

PREHEAT: 150~180°C (60~120s)

2. SOLDERING TEMPERATURE: 280~300°C (MAX 2s)

3. COPLANARITY OF LEADS SHALL BE 0.1mm MAX.

4. RECOMMENDED THICKNESS FOR PC BOARD IS 1.6mm.

5. RECOMMENDED THICKNESS FOR SOLDER PASTE IS 0.15mm.

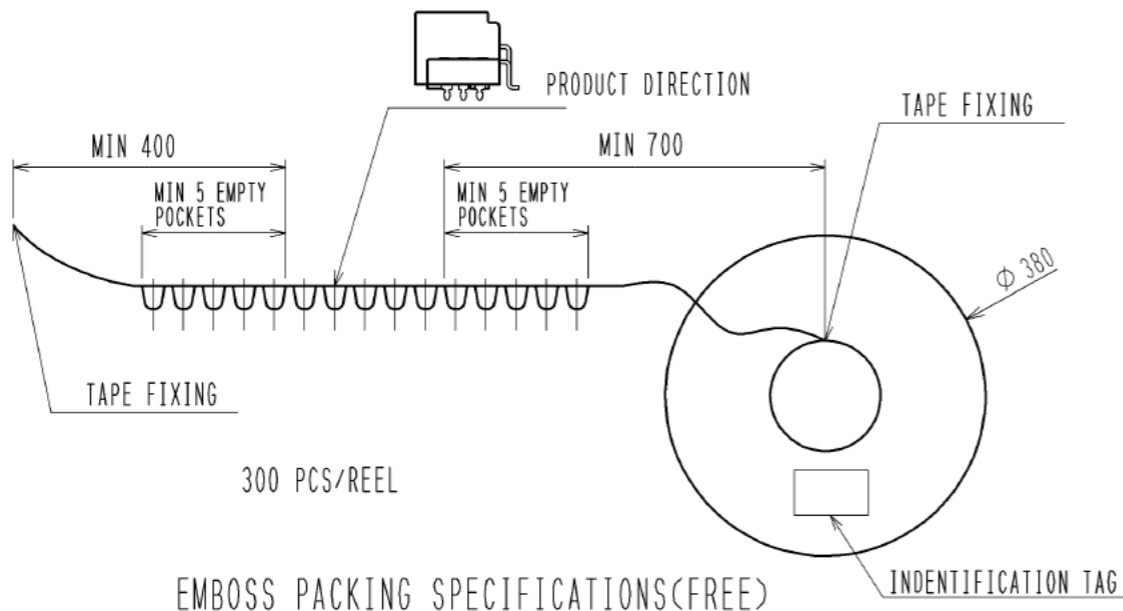
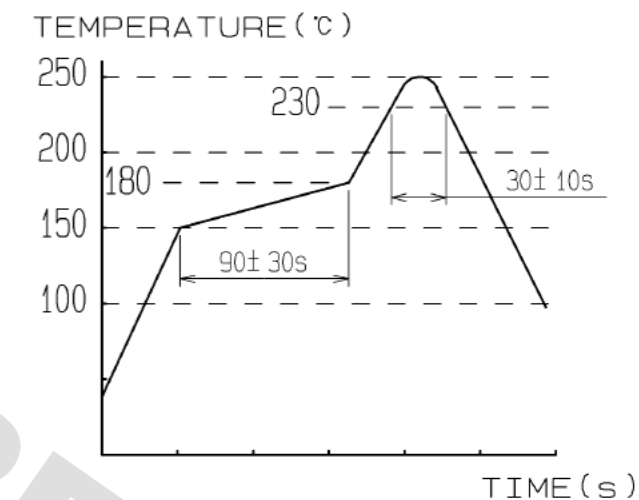

EMBOSS PACKING SPECIFICATIONS(FREE)

2	BRASS	TIN PLATING	4	BRASS	TIN PLATING
1	PPS	BLACK	3	BRASS	TIN PLATING
NO.	MATERIAL	FINISH . REMARKS	NO.	MATERIAL	FINISH . REMARKS
UNITS mm		SCALE 2 : 1	COUNT 1	DESCRIPTION OF REVISIONS DIS-T-003270	DESIGNED RZ. KANO
<b>HRS</b> HIROSE ELECTRIC CO., LTD.		APPROVED : AR. SHIRAI	12.09.14	DRAWING NO. EDC3-167885-00	CHECKED HS. OZAWA
		CHECKED : NH. NAKATA	12.09.14	PART NO. GT8E-16DP-2H	DATE 13.04.17
		DESIGNED : RZ. KANO	12.09.13	CODE NO. CL758-1009-5-00	
		DRAWN : RZ. KANO	12.09.13		

DRAWING FOR REFERENCE: This is subject to change without notice  
05/31/2013

## X-ON Electronics

Largest Supplier of Electrical and Electronic Components

*Click to view similar products for [Automotive Connectors](#) category:*

*Click to view products by [Hirose](#) manufacturer:*

Other Similar products are found below :

[003-018-000](#) [60403001](#) [60993906-B](#) [M902-2131](#) [M902-2161](#) [72.330.1035.1](#) [73.353.4028.0](#) [F119300-B](#) [F166900](#) [F258300-B](#) [F358300-B](#)  
[F407400](#) [F444110](#) [F487000](#) [F509500B-B](#) [827153-1](#) [8N1515-32-24P](#) [9-1326729-8](#) [925474-1](#) [928905-1](#) [964562-4](#) [968782-1](#) [GT17SA-8DS-](#)  
[HU](#) [98891-1012](#) [98947-1016](#) [12004147](#) [12004475-L](#) [12010290](#) [12010309-B](#) [12015454](#) [12020219-B](#) [12020308](#) [12041318-B](#) [12052225-L](#)  
[12052466](#) [12059125](#) [12064869](#) [12004327-B](#) [12010503-B](#) [12015308](#) [12015384](#) [12015909](#) [1-21030-1](#) [12041254](#) [12041318](#) [12047946-B](#)  
[12047957](#) [12047957-L](#) [12059473](#) [12066261](#)