

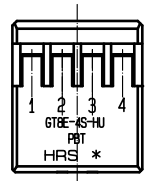

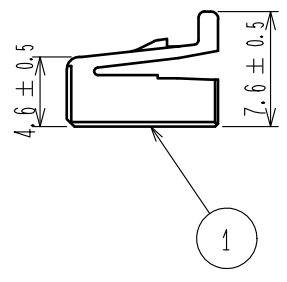
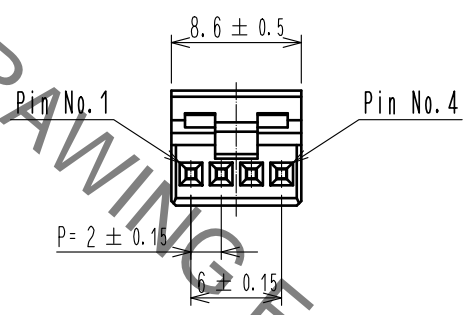
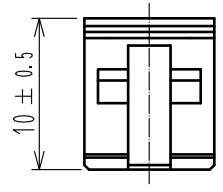

Jun.1.2019 Copyright 2019 HIROSE ELECTRIC CO., LTD. All Rights Reserved.  
 In case of consideration for using Automotive equipment / device which demand high reliability, kindly contact our sales window correspondents.

ELV. ROHS COMPLIANT

 Delete unnecessary lines

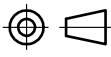

NOTE 1. THE APPLICABLE TERMINAL IS GT8B-2428SCF(CL758-0055-7)  
 OR GT8E-2022SCF(CL758-0033-4).

1	PBT	BLACK						
NO.	MATERIAL	FINISH	REMARKS	NO.	MATERIAL	FINISH	REMARKS	
UNITS mm		SCALE 2 : 1	COUNT  1	DESCRIPTION OF REVISIONS DIS-T-00003709		DESIGNED DONGCHAN KIM	CHECKED HS.OZAWA	DATE 18.08.22
 HIROSE ELECTRIC CO., LTD.		APPROVED : AR. SHIRAI	10.10.19	DRAWING NO. EDC-166702-00-01				
		CHECKED : NH. NAKATA	10.10.18	PART NO. GT8E-4S-HU				
		DESIGNED : NA. HARUBAYASHI	10.10.18	CODE NO. CL758-0047-9-00				
		DRAWN : Chindaik.Ng	10.10.18			 1/1		

## X-ON Electronics

Largest Supplier of Electrical and Electronic Components

*Click to view similar products for [Automotive Connectors](#) category:*

*Click to view products by [Hirose](#) manufacturer:*

Other Similar products are found below :

[003-018-000](#) [60403001](#) [60993906-B](#) [M902-2131](#) [M902-2161](#) [72.330.1035.1](#) [73.353.4028.0](#) [F119300-B](#) [F166900](#) [F258300-B](#) [F358300-B](#)  
[F407400](#) [F444110](#) [F487000](#) [F509500B-B](#) [827153-1](#) [8N1515-32-24P](#) [9-1326729-8](#) [925474-1](#) [928905-1](#) [964562-4](#) [968782-1](#) [GT17SA-8DS-](#)  
[HU](#) [98891-1012](#) [98947-1016](#) [12004475-L](#) [12010290](#) [12010309-B](#) [12015454](#) [12020219-B](#) [12020308](#) [12041318-B](#) [12052225-L](#) [12052466](#)  
[12059125](#) [12064869](#) [12004327-B](#) [12010503-B](#) [12015308](#) [12015384](#) [12015909](#) [1-21030-1](#) [12041254](#) [12041318](#) [12047946-B](#) [12047957](#)  
[12047957-L](#) [12059473](#) [12066261](#) [12110546](#)