

ELV. RoHS COMPLIANT

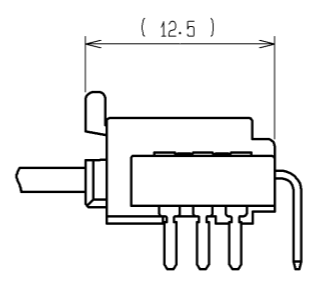

MATING CONFIGURATION

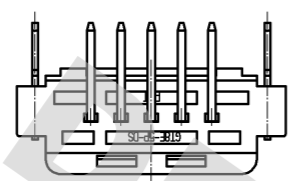
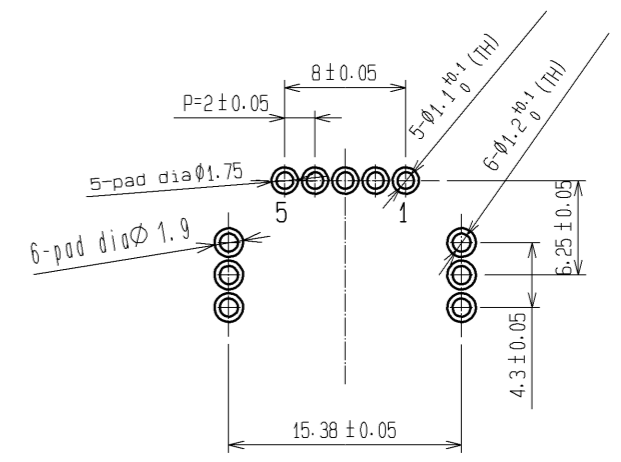

RECOMMENDED PC BOARD AND PIN NO.

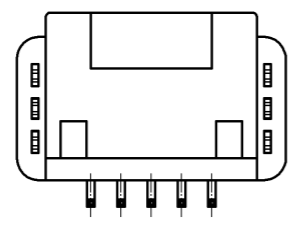
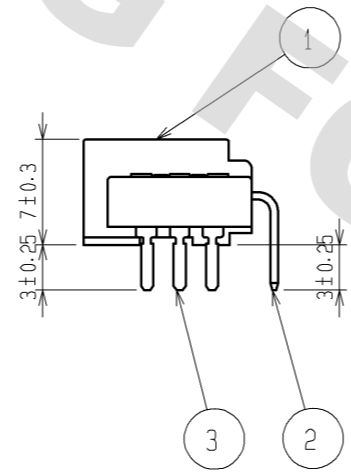
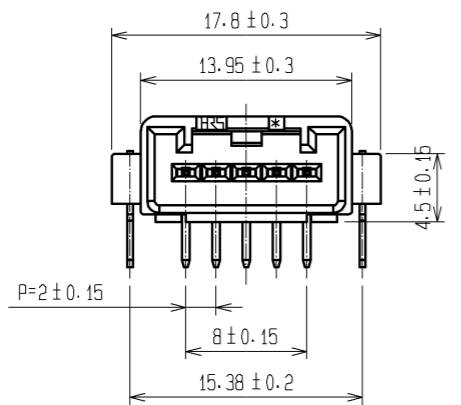
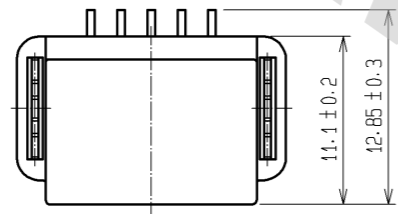

DRAWING FOR REFERENCE: This is subject to change without notice
08/11/2012

3	BRASS	TIN PLATING					
1	PBT	BLACK	3	BRASS	TIN PLATING		
NO.	MATERIAL	FINISH . REMARKS	NO.	MATERIAL	FINISH . REMARKS		
UNITS mm		SCALE 2 : 1	COUNT △	DESCRIPTION OF REVISIONS	DESIGNED	CHECKED	DATE
HRS HIROSE ELECTRIC CO., LTD.		APPROVED : AR. SHIRAI	11.03.25	DRAWING NO.	EDC3-166759-01		
		CHECKED : AR. SHIRAI	11.03.25	PART NO.	GT8E-5P-DS		
		DESIGNED : Chinoik.Ng	11.03.25	CODE NO.	CL758-0058-5-00		
		DRAWN : Chinoik.Ng	11.03.25		△ 1/1		

X-ON Electronics

Largest Supplier of Electrical and Electronic Components

Click to view similar products for [Automotive Connectors](#) category:

Click to view products by [Hirose](#) manufacturer:

Other Similar products are found below :

[003-018-000](#) [60403001](#) [60993906-B](#) [M902-2131](#) [M902-2161](#) [72.330.1035.1](#) [73.353.4028.0](#) [F119300-B](#) [F166900](#) [F258300-B](#) [F358300-B](#)
[F407400](#) [F444110](#) [F487000](#) [F509500B-B](#) [827153-1](#) [8N1515-32-24P](#) [9-1326729-8](#) [925474-1](#) [928905-1](#) [964562-4](#) [968782-1](#) [GT17SA-8DS-](#)
[HU](#) [98891-1012](#) [98947-1016](#) [12004475-L](#) [12010290](#) [12010309-B](#) [12015454](#) [12020219-B](#) [12020308](#) [12041318-B](#) [12052225-L](#) [12052466](#)
[12059125](#) [12064869](#) [12004327-B](#) [12010503-B](#) [12015308](#) [12015384](#) [12015909](#) [1-21030-1](#) [12041254](#) [12041318](#) [12047946-B](#) [12047957](#)
[12047957-L](#) [12059473](#) [12066261](#) [12110546](#)