

# GT8 SERIES

— High-Pressure Connector —  
< GT8 • GT8A • GT8C • GT8Z >

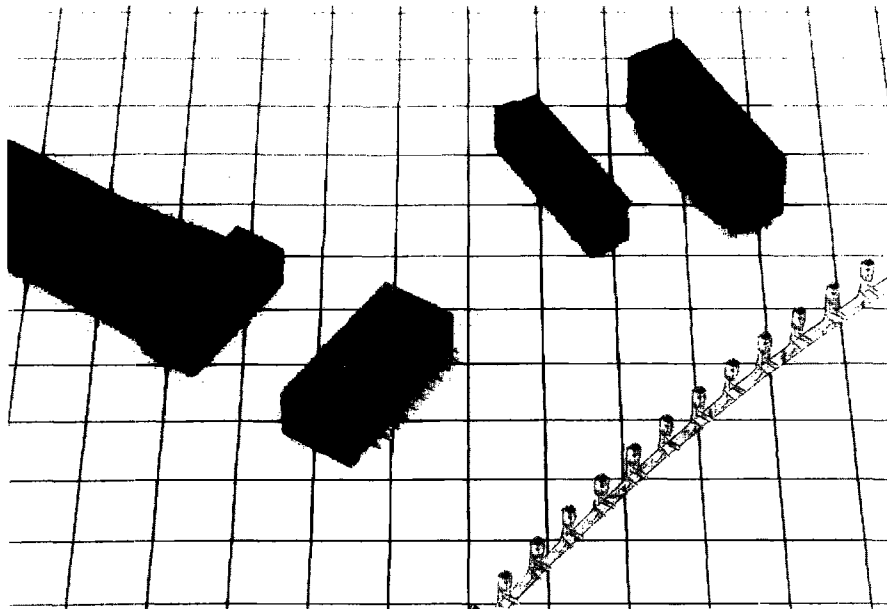

## Features

### Crimp terminal

- (1) Crimp socket contacts have a gastight pressure point.

### Socket housing

- (1) All contact cavity numbers marked with large figures for easy and secure contact insertion process.
- (2) Shaped to prevent incomplete insertion.

### Pin header

- (1) Provided with a drain hole to prevent secondary contamination by washing solution.
- (2) Fully shrouded to prevent contact damage.

### Others

- (1) The whole socket housing is embedded in the pin header,
  - (a) to prevent imperfect insertion of connectors and
  - (b) prying, and also
  - (c) to be guarded so that the connector is resistant to vibration, thereby avoiding slanting or displacement of the contacts.
- (2) The socket housing is different in color from the pin header to prevent incomplete insertion.

## Applications

Internal connection of car units.

## Crimp socket contact

● **GTM5-2428SCF**  
HRS No. 558-0014-3

Item	Material	Treatment
Crimp terminal	Phosphor bronze	Tin-plated

- (1) High-pressure contact construction.
- (2) Castight pressure point.
- (3) Main-contact box protection mechanism.
- (4) High-pressure buffer spring mechanism.
- (5) Barrel construction longer than that of the same class of crimp contacts for 2 mm grids (can preserve a high degree of crimping reliability).
- (6) Crimp barrel dimple prevents the tearing-off of wire insulation.
- (7) Center conductor and wire insulation crimp barrels are widely spaced to preserve the reliability of crimping.

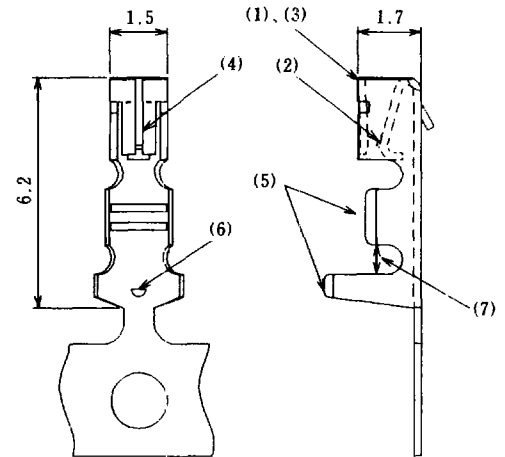

**Note:** Minimum order lot is one reel.  
10,000 terminals per reel.

\* Separate contacts for use with hand tools are also available: GTM5-2428SC (HRS No. 558-0056-3).

● **GT8-20DS-2C**  
HRS No. 559-0030-6

Item	Material	Treatment
Housing	PBT	Dark gray

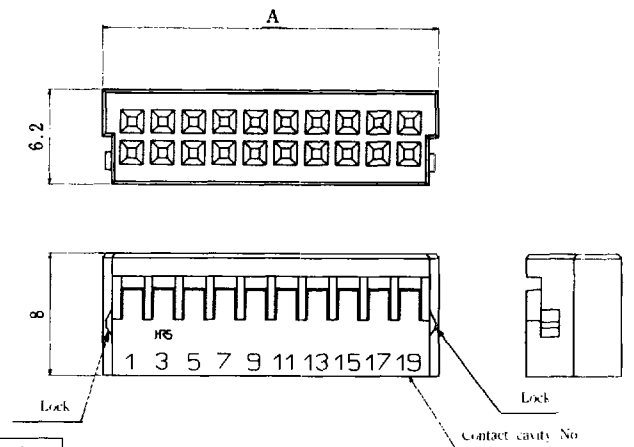
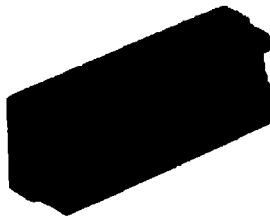

HRS No.	Product No.	No. of contacts	A dimension	Specifications
---	GT8-14DS-2C	14	---	Without lock
559-0030-6	GT8-20DS-2C	20	21.8	
559-0053-1	GT8-24DS-2C	24	25.8	
559-0114-4	GT8A-20DS-2C	20	21.8	
559-0115-7	GT8A-24DS-2C	24	25.8	

\* Planned

● **GT8Z-20DS-2C**  
HRS No. 559-0089-9

Item	Material	Treatment
Housing	PBT	Dark gray

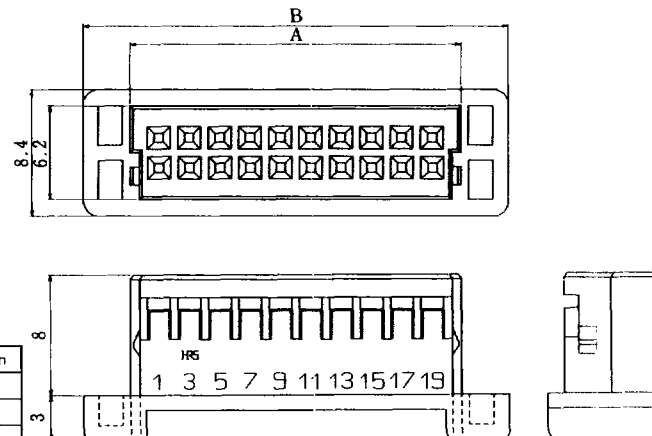
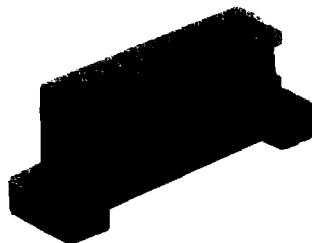

HRS No	Product No.	No. of contacts	A dimension	B dimension
559-0091-0	GT8Z-14DS-2C	14	15.8	22
559-0089-9	GT8Z-20DS-2C	20	21.8	28
559-0090-8	GT8Z-24DS-2C	24	25.8	32

**Note:** This product engages with GT8- and GT8A-\*DP-2DSA.

● **GT8-20DP-2DSA**  
HRS No. 559-0031-9

Item	Material	Treatment
Pin header	PBT	Light gray
DSA terminal	Brass	Tin-plated

Note: This model includes molded-in contacts.

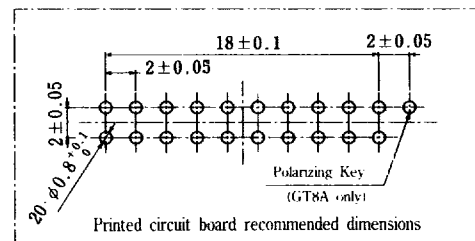
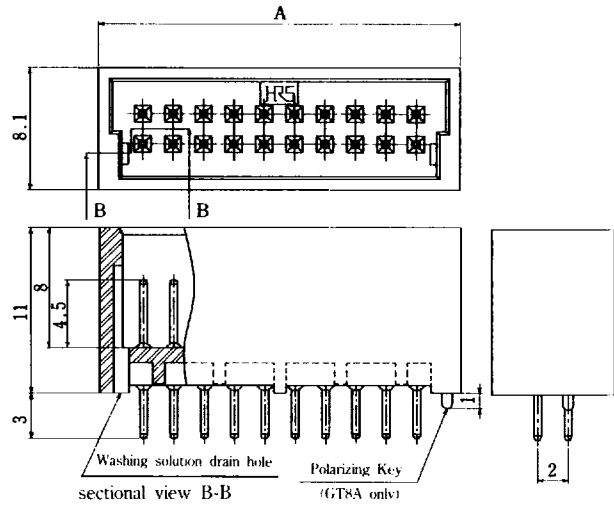
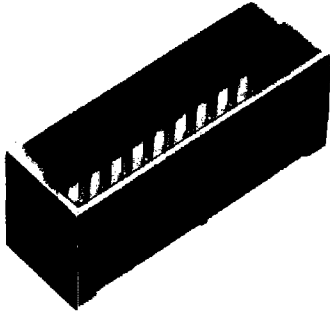

HRS No.	Product No.	No. of contacts	A dimension	Specifications
559-0031-9	GT8-20DP-2DSA	20	23.8	With an insertion error prevention key
559-0054-4	GT8-24DP-2DSA	24	27.8	
559-0092-3	GT8A-14DP-2DSA	14	17.8	
559-0120-7	GT8A-20DP-2DSA	20	23.8	
559-0121-0	GT8A-24DP-2DSA	24	27.8	

⚡ Planned

● **Connectors with Feed-Through Capacitor**

● **GT8C-20DP-2DSA**  
HRS No. CL559-0141-7

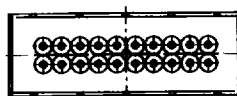
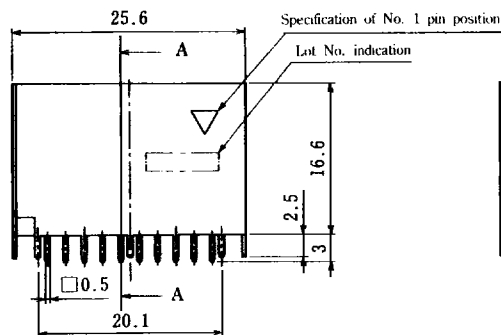
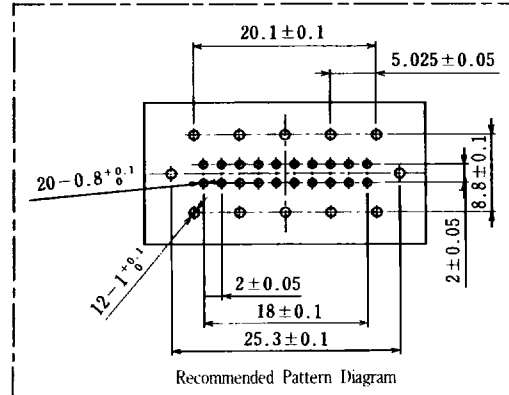
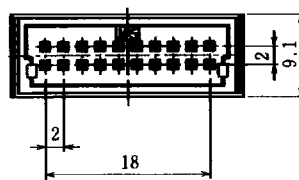
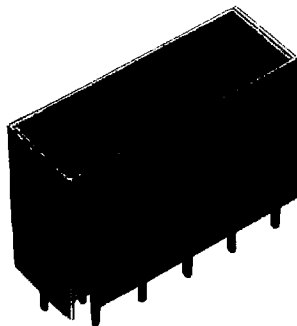

⚡ The inclusion of a 1,000 pF capacitor is standard.  
Please contact our business representative for other requirements.

## Terminating tools

User's manuals are available for the various wiring tools. Please contact a business representative.

### Automatic crimping machine

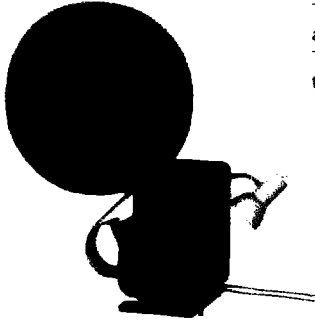

The photograph shows an example. The machines are subject to change.

HRS No. 901-0005-4  
Product No. CM-105

Applicator die part No.	HRS No.
Applicator 105-GTM5	901-0064-4

### Specifications

Item	Capacity	Notes
Capacity	1.5 tons	
Stroke length	30 mm	
Number of strokes	200 spm (50 Hz)	240 spm (60 Hz)
Weight	75 kg	
Motor	0.2 kW	100 V AC
Crimping speed	2,000 to 4,000 pieces/H	

### Hand tool



Hand tool part No.	Hand No.
GTM5-TA26HC	550-0229-9

※ For information about the crimp heights of the terminals, please contact a business representative for crimp height setting tables which are available for each cable type. Please note that settings will be made for the new crimp heights of new cables and that these will be made available after several days when ready.

## X-ON Electronics

Largest Supplier of Electrical and Electronic Components

*Click to view similar products for [Automotive Connectors](#) category:*

*Click to view products by [Hirose](#) manufacturer:*

Other Similar products are found below :

[003-018-000](#) [60403001](#) [60993906-B](#) [M902-2131](#) [M902-2161](#) [72.330.1035.1](#) [73.353.4028.0](#) [F119300-B](#) [F166900](#) [F258300-B](#) [F358300-B](#)  
[F407400](#) [F444110](#) [F487000](#) [F509500B-B](#) [827153-1](#) [8N1515-32-24P](#) [9-1326729-8](#) [925474-1](#) [928905-1](#) [964562-4](#) [968782-1](#) [GT17SA-8DS-](#)  
[HU](#) [98891-1012](#) [98947-1016](#) [12004475-L](#) [12010290](#) [12010309-B](#) [12015454](#) [12020219-B](#) [12020308](#) [12041318-B](#) [12052225-L](#) [12052466](#)  
[12059125](#) [12064869](#) [12004327-B](#) [12010503-B](#) [12015308](#) [12015384](#) [12015909](#) [1-21030-1](#) [12041254](#) [12041318](#) [12047946-B](#) [12047957](#)  
[12047957-L](#) [12059473](#) [12066261](#) [12110546](#)