

Sep.1.2021 Copyright 2021 HIROSE ELECTRIC CO., LTD. All Rights Reserved.
In case of consideration for using Automotive equipment / device which demand high reliability, kindly contact our sales window correspondents.

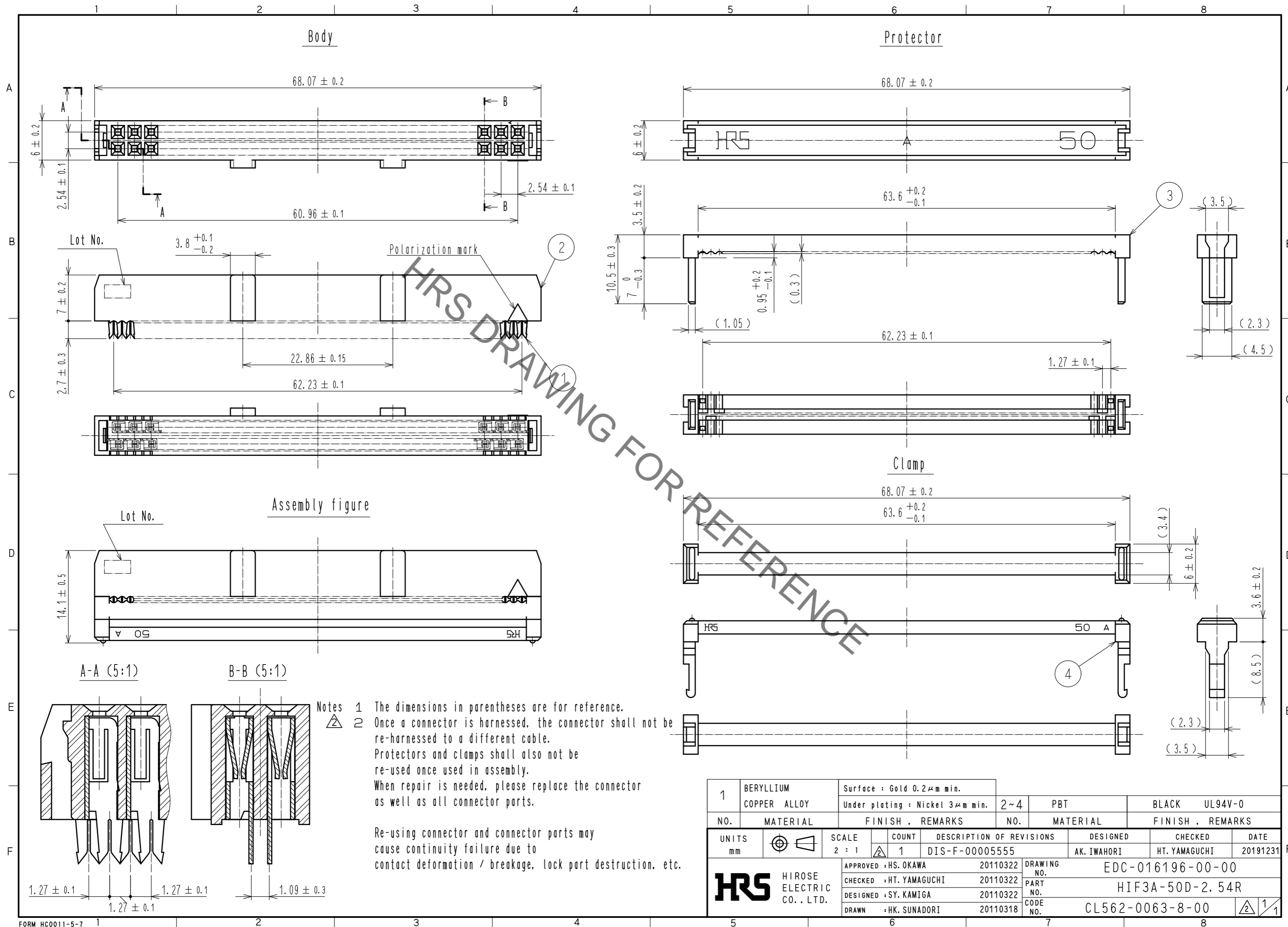

1	BERYLLIUM COPPER ALLOY	Surface : Gold 0.2µm min. Under plating : Nickel 3µm min.	2~4	PBT	BLACK	UL94V-0
NO.	MATERIAL	FINISH . REMARKS	NO.	MATERIAL	FINISH . REMARKS	
UNITS mm		SCALE 2 : 1	COUNT 1	DESCRIPTION OF REVISIONS DIS-F-00005555	DESIGNED AK. IWAHORI	CHECKED HT. YAMAGUCHI
HRS HIROSE ELECTRIC CO., LTD.		APPROVED : HS. OKAWA	20110322	DRAWING NO.	EDC-016196-00-00	
		CHECKED : HT. YAMAGUCHI	20110322	PART NO.	HIF3A-50D-2.54R	
		DESIGNED : SY. KAMIGA	20110322	CODE NO.	CL562-0063-8-00	
		DRAWN : HK. SUNADORI	20110318		1/1	

X-ON Electronics

Largest Supplier of Electrical and Electronic Components

Click to view similar products for [Headers & Wire Housings](#) category:

Click to view products by [Hirose](#) manufacturer:

Other Similar products are found below :

[892-18-020-10-001101](#) [58102-G61-06LF](#) [582553-1](#) [0009485154](#) [009176003701906](#) [0050291907](#) [LY20-4P-DT1-P1E-BR](#) [02.125.8002.8](#)
[609-3404](#) [61062-3](#) [622-0430](#) [622-3653LF](#) [63453-116](#) [636-1030](#) [636-1427](#) [636-3427](#) [636-4007](#) [641938-9](#) [641991-4](#) [644827-2](#) [65817-010LF](#)
[65817-015LF](#) [65863-015LF](#) [66207-023LF](#) [67095-007LF](#) [67601157](#) [68648-049](#) [70.362.1628.0](#) [70-4210](#) [70-4226B](#) [70-4853B](#) [707-5020](#) [707-](#)
[5028](#) [71.350.2428.0](#) [71918-208LF](#) [71961-016LF](#) [733-134](#) [733-162](#) [754199-000](#) [760-3052](#) [787-8014-00](#) [79531-3000](#) [FCN-360C032-B](#) [FCN-](#)
[367T-T012/H](#) [FCN-723D010/2](#) [80.063.4001.1](#) [800-90-001-10-001000](#) [800-90-010-10-002000](#) [801-43-002-10-013000](#) [801-43-006-10-002000](#)