

2.92mm Series

2.92mm Coaxial Connectors MIL Standard Compliant

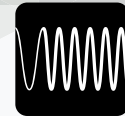

Milimeter Wave



COAX 2.92mm



MIL Standard



Features

1. Compliant MIL-STD-348B Standard

2. Supports up to 40GHz frequency

3. Screw mounting

- Provides excellent high frequency performance and consistent mounting quality
- Reusable
- Reduces mounting complexity (No Soldering is required)

4. Flexible PCB thickness

5. Compatible with 0.085 inch flexible cable

6. Attenuators and terminators are also available.

7. RoHS2 compliant

Applications

Data transmission measurement, Radio communication equipment, Measuring instruments, RF module, Radio power amplifier, High speed router, High speed switch, Broadcasting equipment etc.

Product Specifications

Nominal Characteristic Impedance	50 Ω	Operating Temperature	-55 to +105°C (95% RH or less)
Rated Frequency	DC to 40GHz	Storage Temperature Range	-55 to +50°C (95% RH or less)

Items	Specifications	Conditions	
Contact Resistance	Center : Not greater than 6m Ω External : Not greater than 2m Ω	Measured at 100mA or below	
Insulation Resistance	1,000M Ω Min.	Measured at 500V DC	
Withstanding Voltage	No flashover or breakdown	500V AC for one minute	
Voltage Standing Wave Ratio	<ul style="list-style-type: none"> ● HK-P-SF085, HK-R-201/401 V.S.W.R. : Not greater than 1.15 (DC to 18GHz) V.S.W.R. : Not greater than 1.20 (18 to 26.5GHz) V.S.W.R. : Not greater than 1.35 (26.5 to 40GHz) ● HK-R-SR2-1 V.S.W.R. : Not greater than 1.10 (DC to 18GHz) V.S.W.R. : Not greater than 1.15 (18 to 26.5GHz) V.S.W.R. : Not greater than 1.30 (26.5 to 40GHz) ● HK-LR-SR2 V.S.W.R. Not greater than 1.30 (DC to 40GHz) ● HK-R-SR2-S V.S.W.R. : Not greater than 1.30 (DC to 20GHz) V.S.W.R. : Not greater than 1.45 (20 to 40GHz) 		
	Mating Cycles	Contact resistance at center : Not greater than 8m Ω External : Not greater than 4m Ω No broken, cracked, or loose parts	500 cycles
	Vibration Resistance	No electrical discontinuity for not less than 1 μ s. No broken, cracked, or loose parts	Frequency : 10 to 2000Hz, half amplitude : 0.75mm, Acceleration : 196m/s ² , 10 cycles in each of the 3 axis
	Shock Resistance	No electrical discontinuity for not less than 1 μ s. No broken, cracked, or loose parts	Acceleration : 1960m/s ² , duration : 6ms, Wave form : half-sine wave, 3 times in each of the 3 axis
Moisture Resistance of Temperature/ Humidity Cycle	Insulation resistance : Not less than 100M Ω (in a high humidity environment) Insulation resistance : Not less than 1,000M Ω (in a dry environment) No broken, cracked or loose parts	Left for 10 cycles (240 hours) in an environment with the temperature ranging from -10 to 65°C and the humidity ranging from 90 to 98%.	
Temperature Cycle	No broken, cracked or loose parts	5 cycles of the following test series condition : Temperature : -55°C → - → +105°C → - Time : 30 min. → 3 min. → 30 min. → 3 min.	
Salt Spray	No considerable corrosion	Continuous 48 hour cycle in 5% salt water solution	

*Measurement of voltage standing wave ratio (V.S.W.R.)

The specified values of the voltage standing wave ratio (V.S.W.R.) noted above, are taken with the test set up shown in the figure below.

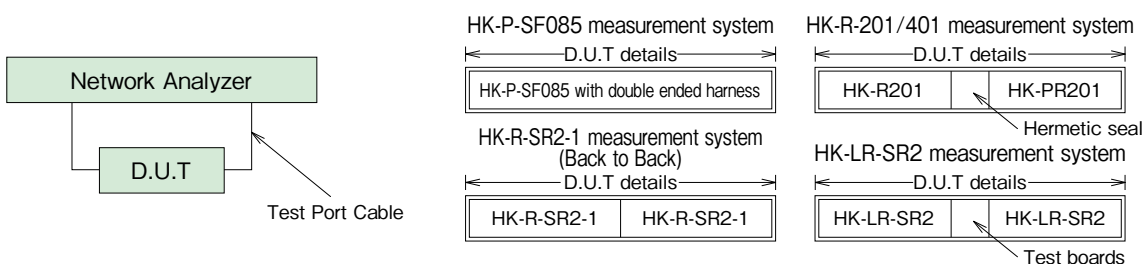

Materials / Finish

Part	Materials	Finish
Shell	Stainless Steel / Brass	Passivated / Gold Plating
Insulator	PPO / PTFE / PEI Resin	-
Contact	Beryllium Copper	Gold Plated
Ring	Stainless Steel	Gold Plated

Product Number Structure

Refer to the chart below when determining the product specifications from the product number.
Please select from the product numbers listed in this catalog when placing orders.

HK - [] - []

① ② ③

① Series Name	HK	③ Applicable Cable or Board Mounting Style	SF085 : 0.085-inch, Flexible Cable SR : PCB screw-mounting
② Connector Type	P : Straight Plug R : Receptacle PR : Plug Receptacle A : Adapter		

Functional Diagram

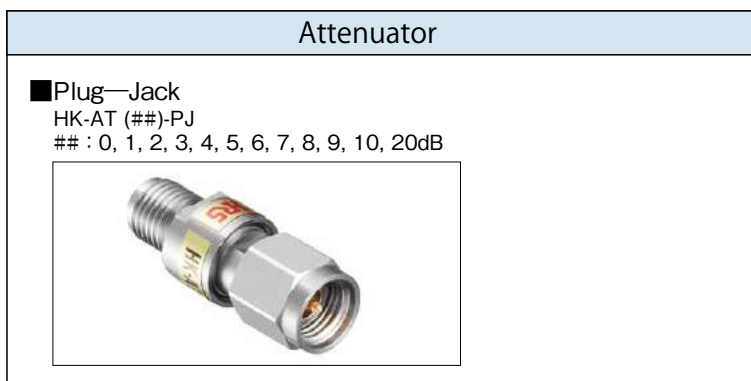
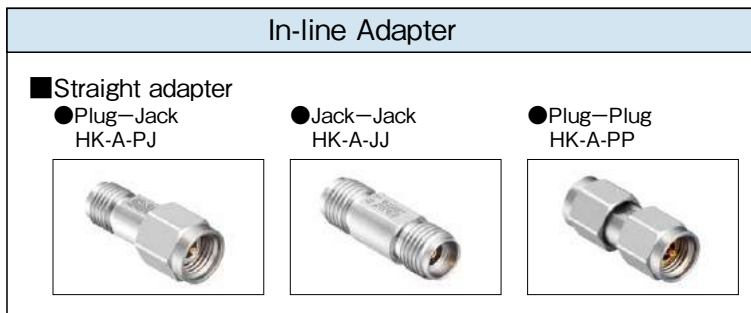
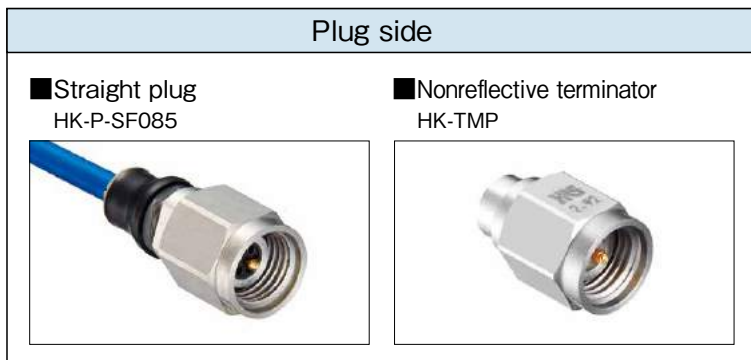

Plug

Please contact Hirose in case of cable assemblies.

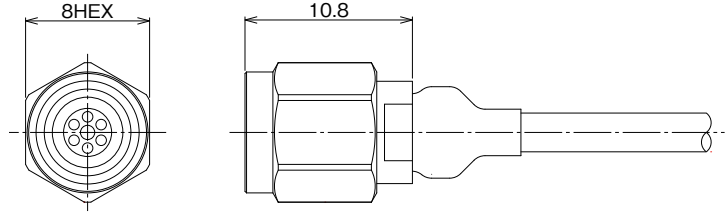

Part No.	HRS No.	Purchase Unit
HK-P-SF085	CL0338-0081-0-00	20pcs per bag

Cable Harness (HK Straight Plug - HK Straight Plug)

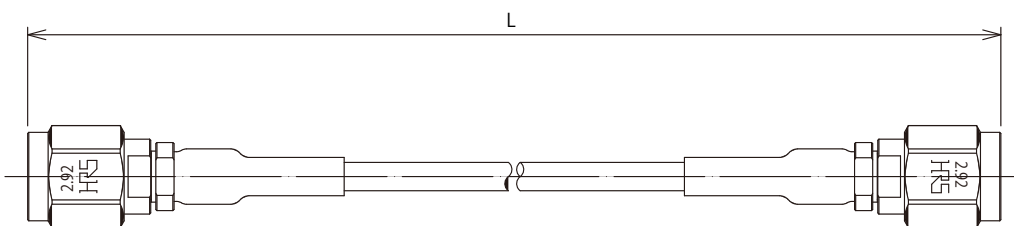
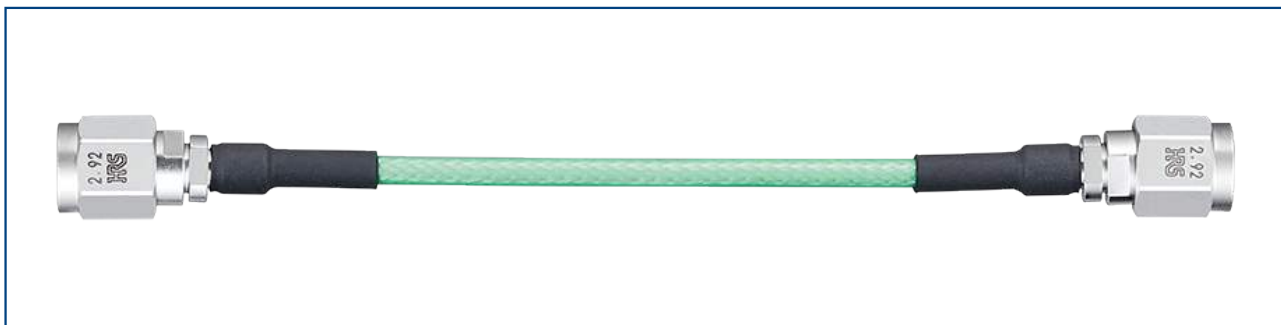

Part No.	HRS No.	Harness Length L		Purchase Unit
		Unit : inch	Unit : mm	
HK-2P-MC1-A-4IN	CL0321-1934-0-03	4 ± 0.16	101.6 ± 4	20pcs per bag
HK-2P-MC1-A-5IN	CL0321-1934-0-04	5 ± 0.16	127.0 ± 4	
HK-2P-MC1-A-6IN	CL0321-1934-0-05	6 ± 0.16	152.4 ± 4	
HK-2P-MC1-A-7IN	CL0321-1934-0-06	7 ± 0.16	177.8 ± 4	
HK-2P-MC1-A-8IN	CL0321-1934-0-07	8 ± 0.32	203.2 ± 8	
HK-2P-MC1-A-9IN	CL0321-1934-0-08	9 ± 0.32	228.6 ± 8	
HK-2P-MC1-A-10IN	CL0321-1934-0-09	10 ± 0.32	254.0 ± 8	
HK-2P-MC1-A-12IN	CL0321-1934-0-10	12 ± 0.32	304.8 ± 8	
HK-2P-MC1-A-18IN	CL0321-1934-0-11	18 ± 0.32	457.2 ± 8	
HK-2P-MC1-A-24IN	CL0321-1934-0-12	24 ± 0.48	609.6 ± 12	
HK-2P-MC1-A-36IN	CL0321-1934-0-13	36 ± 0.48	914.4 ± 12	
HK-2P-MC1-A-48IN	CL0321-1934-0-14	48 ± 0.71	1219.2 ± 18	
HK-2P-MC1-A-60IN	CL0321-1934-0-15	60 ± 0.87	1524.0 ± 22	
HK-2P-MC1-A-72IN	CL0321-1934-0-16	72 ± 1.07	1828.8 ± 27	

Receptacle

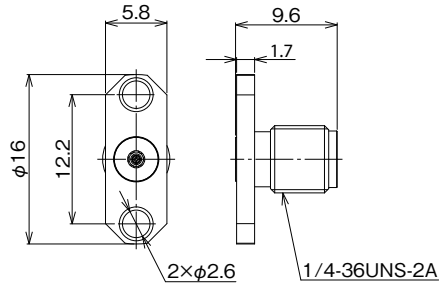

Part No.	HRS No.	Purchase Unit
HK-R201	CL0338-0073-1-00	20pcs per bag

Note : Compliant with hermetic seal of ϕ 0.3mm pin.

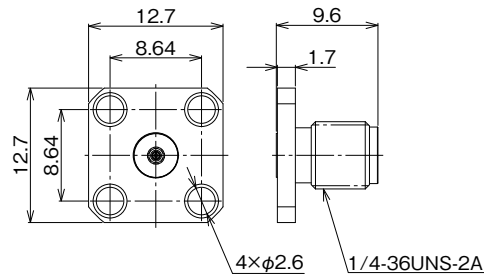

Part No.	HRS No.	Purchase Unit
HK-R401	CL0338-0074-4-00	20pcs per bag

Note : Compliant with hermetic seal of ϕ 0.3mm pin.

Plug-Receptacle

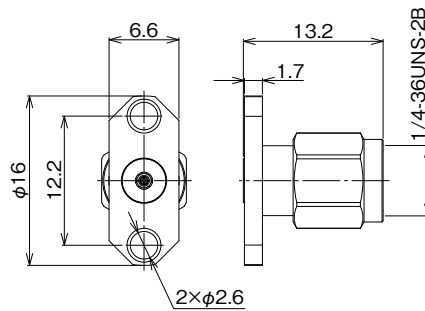

Part No.	HRS No.	Purchase Unit
HK-PR201	CL0338-0075-7-00	20pcs per bag

Note : Compliant with hermetic seal of ϕ 0.3mm pin.

PCB Vertical Mount Receptacle (For High Speed Transmission Evaluation Board Ports)

This receptacle is designed for high speed test board applications. Not applicable to actual commercial equipments.

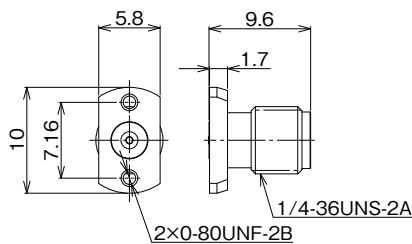

Part No.	HRS No.	Attached Screw	Purchase Unit
HK-R-SR2-1	CL0338-0003-0-00	-	20pcs per bag
HK-R-SR2-1(11)	CL0338-0003-0-11	0-80UNF 1/4 inch	
HK-R-SR2-1(12)	CL0338-0003-0-12	0-80UNF 3/16 inch	

◆ Frequency characteristics (TYPICAL)

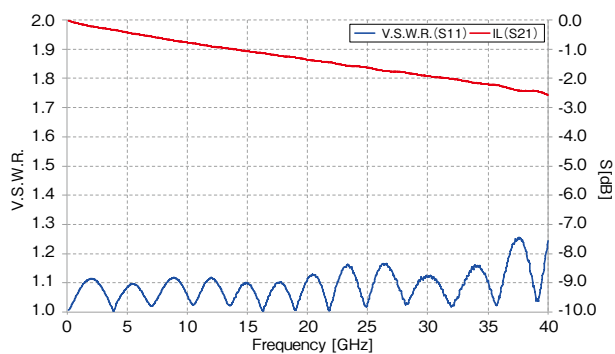

*Signal line length between both connector ends : 25mm

● Surface Trace Type

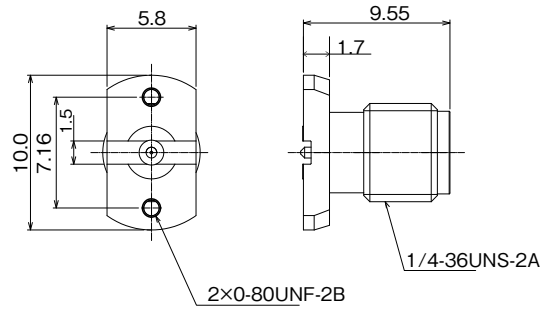

Part No.	HRS No.	Attached Screw	Purchase Unit
HK-R-SR2-S	CL0338-0006-0-00	-	20pcs per bag
HK-R-SR2-S(11)	CL0338-0006-0-11	0-80UNF 1/4 inch	
HK-R-SR2-S(12)	CL0338-0006-0-12	0-80UNF 3/16 inch	

◆ Frequency characteristics (TYPICAL)

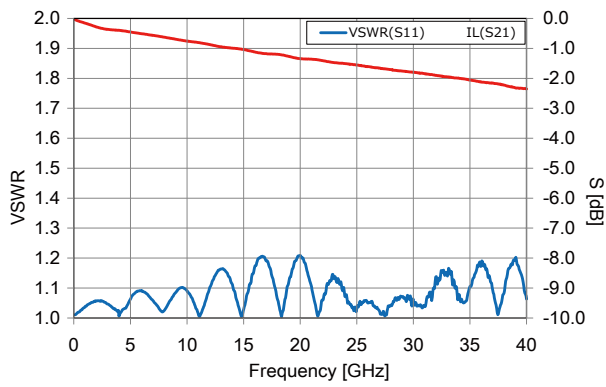

*Signal line length between both connector ends : 25mm

PCB End Launch Receptacle (For High Speed Transmission Evaluation Board Ports)

Receptacle for measuring high speed evaluation boards. Can be used without soldering the center contact. It cannot be mounted on devices.

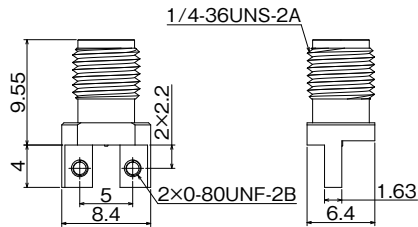

Part No.	HRS No.	Attached Screw	Purchase Unit
HK-LR-SR2	CL0338-0079-0-00	-	20pcs per bag
HK-LR-SR2(11)	CL0338-0079-0-11	0-80UNF 1/4 inch	
HK-LR-SR2(12)	CL0338-0079-0-12	0-80UNF 3/16 inch	

◆ Frequency characteristics (TYPICAL)

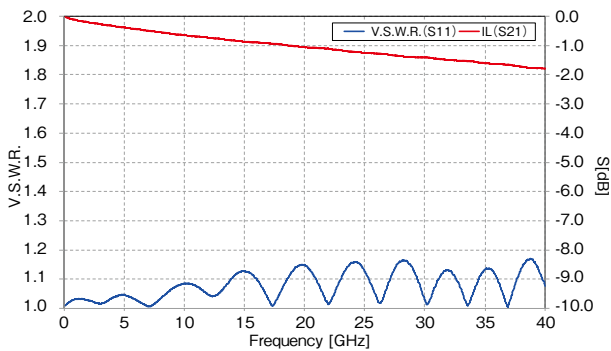

*Coplaner line length between both connector ends : 20mm

In-line Adapter

● Straight Adapter Plug – Jack

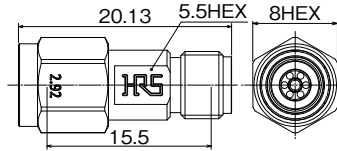

Part No.	HRS No.	V.S.W.R. (Max.)			Purchase Unit
		0 to 18GHz	18 to 26.5GHz	26.5 to 40GHz	
HK-A-PJ	CL0338-0097-0-00	1.1	1.15	1.2	20pcs per bag

Jack – Jack

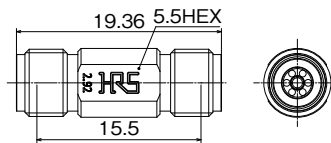

Part No.	HRS No.	V.S.W.R. (Max.)			Purchase Unit
		0 to 18GHz	18 to 26.5GHz	26.5 to 40GHz	
HK-A-JJ	CL0338-0098-0-00	1.1	1.15	1.2	20pcs per bag

Plug – Plug

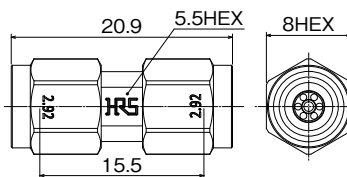

Part No.	HRS No.	V.S.W.R. (Max.)			HRS No.
		0 to 18GHz	18 to 26.5GHz	26.5 to 40GHz	
HK-A-PP	CL0338-0099-0-00	1.1	1.15	1.2	20pcs per bag

◆ Frequency characteristics (TYPICAL)

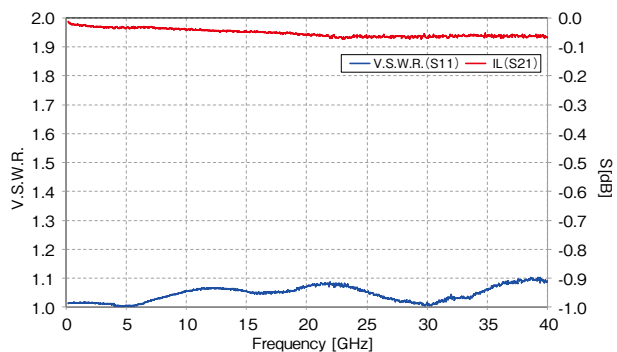

2.92mm-TM Series

2.92mm Coaxial Connectors MIL Standard Compliant/ Nonreflective Terminator

Product Specifications

Nominal Characteristic Impedance	50 Ω	Operating Temperature	-40 to +85°C
Rated Frequency	0 to 40GHz	Operating Relative Humidity	95% RH or less
Power	0.5W CW (+75°C)		

Materials / Finish

Part	Materials	Finish
Shell	Stainless Steel	Passivate
Insulator	PTFE	-
Male Contact	Brass	Gold Plated
Coupling	Stainless Steel	Passivate
Resistive Element	Metal Film	-

Product Number Structure

HK - TM P

① ② ③

① Series Name	HK	③ Connector Type	P : Plug type
② TM	Non-reflective terminator		

Terminator

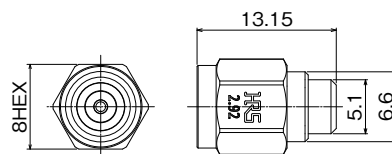

Part No.	HRS No.	V.S.W.R. (Max)				Purchase Unit
		0 to 10GHz	10 to 20GHz	20 to 35GHz	35 to 40GHz	
HK-TMP	CL0353-0014-0-00	1.1	1.15	1.18	1.28	1pc per bag

Frequency Characteristics (TYPICAL)

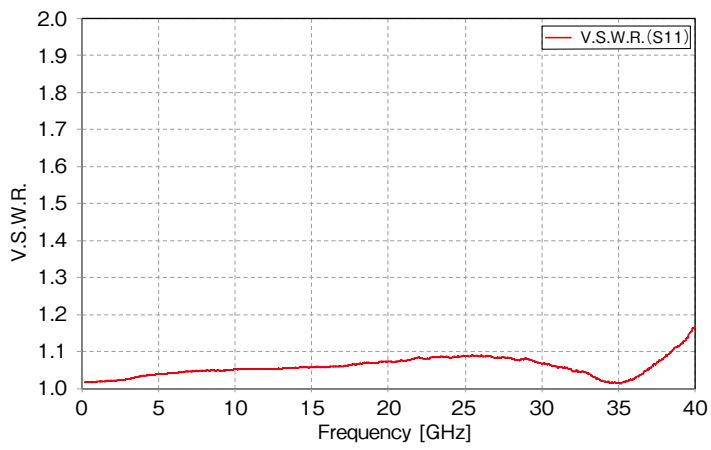

2.92mm Coaxial Connectors MIL Standard Compliant/ Attenuator

Product Specifications

Nominal Characteristic Impedance	50 Ω	Operating Temperature	-10 to +65°C
Rated Frequency	0 to 40GHz	Operating Relative Humidity	90% RH or less
Power	1W CW (+65°C)		

Materials / Finish

Part	Materials	Finish
Shell	Stainless Steel	Passivate
Insulator	PTFE	-
Male Contact	Brass	Gold Plated
Female Contact	Beryllium Copper	Gold Plated
Coupling	Stainless Steel	Passivate
Resistive Element	Metal Film	-

Product Number Structure

HK - AT (##) - PJ

① ② ③ ④

① Series Name	HK	③ Attenuation	(Ex) (0) : 0dB (through) (3) : 3dB (10) : 10dB
② AT	Attenuator	④ Connector Type	PJ : Plug Jack

Attenuator

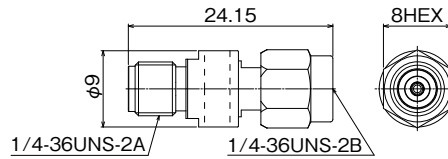

Part No.	HRS No.	Attenuation (dB)			Voltage Standing Wave Ratio (V.S.W.R.)(Max.)		Purchase Unit	
		0 to 18GHz	18 to 26.5GHz	26.5 to 40GHz	0 to 12GHz	12 to 40GHz		
HK-AT(0)-PJ	CL0354-0295-0-00	$0^{+0.4}_0$	$0^{+0.5}_0$	$0^{+0.8}_0$	1.35	1.4	1pc per box	
HK-AT(1)-PJ	CL0354-0316-0-00	$1^{+0.9}_{-0.3}$	$1^{+1.0}_{-0.3}$	$1^{+1.2}_{-0.3}$	1.3			
HK-AT(2)-PJ	CL0354-0317-0-00	$2^{+0.9}_{-0.3}$	$2^{+1.0}_{-0.3}$	$2^{+1.2}_{-0.3}$				
HK-AT(3)-PJ	CL0354-0296-0-00	$3^{+0.7}_{-0.3}$	$3^{+0.8}_{-0.3}$	$3^{+1.0}_{-0.3}$				
HK-AT(4)-PJ	CL0354-0318-0-00	$4^{+0.8}_{-0.4}$	$4^{+0.9}_{-0.4}$	$4^{+1.1}_{-0.4}$				
HK-AT(5)-PJ	CL0354-0319-0-00	$5^{+0.9}_{-0.4}$	$5^{+1.0}_{-0.4}$	$5^{+1.2}_{-0.4}$				
HK-AT(6)-PJ	CL0354-0297-0-00	$6^{+0.8}_{-0.2}$	$6^{+0.9}_{-0.2}$	$6^{+1.0}_{-0.2}$	1.35			1.45
HK-AT(7)-PJ	CL0354-0320-0-00	$7^{+1.0}_{-0.4}$	$7^{+1.1}_{-0.4}$	$7^{+1.3}_{-0.4}$	1.3			1.4
HK-AT(8)-PJ	CL0354-0321-0-00	$8^{+0.9}_{-0.5}$	$8^{+1.0}_{-0.5}$	$8^{+1.2}_{-0.5}$				
HK-AT(9)-PJ	CL0354-0322-0-00	$9^{+0.9}_{-0.5}$	$9^{+1.0}_{-0.5}$	$9^{+1.2}_{-0.5}$				
HK-AT(10)-PJ	CL0354-0298-0-00	$10^{+0.9}_{-0.5}$	$10^{+1.0}_{-0.5}$	$10^{+1.2}_{-0.5}$				1.45
HK-AT(20)-PJ	CL0354-0299-0-00	20 ± 1.0	$20^{+1.2}_{-1.0}$	$20^{+1.4}_{-1.0}$	1.25			1.4

Frequency Characteristics (TYPICAL)

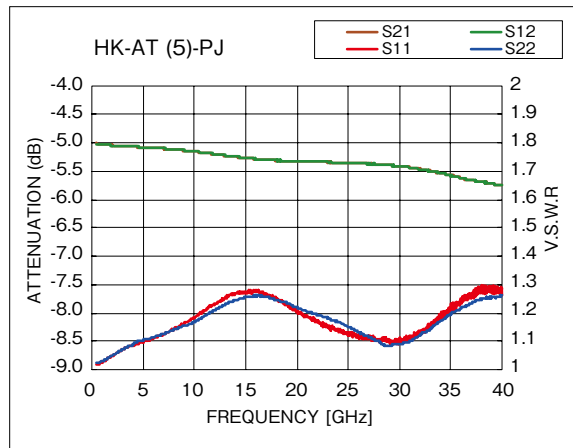
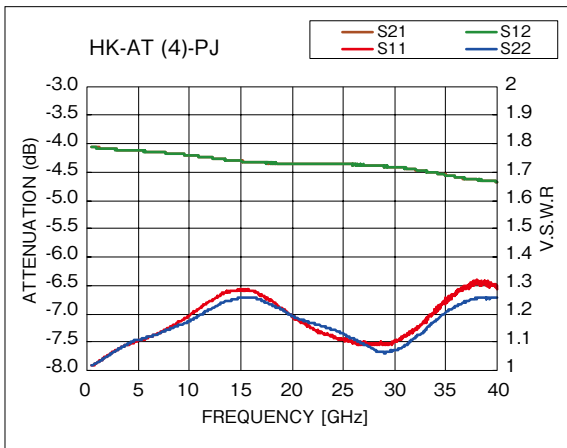
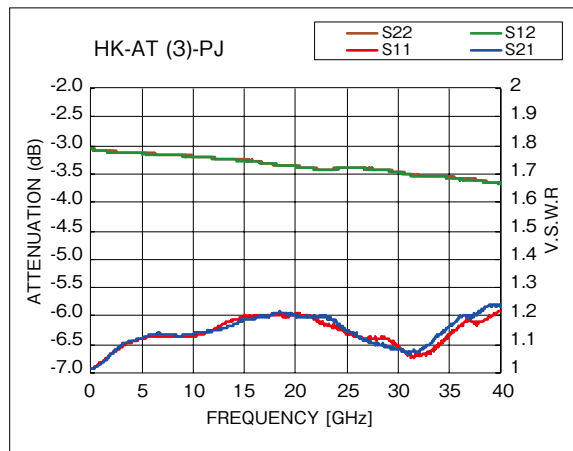
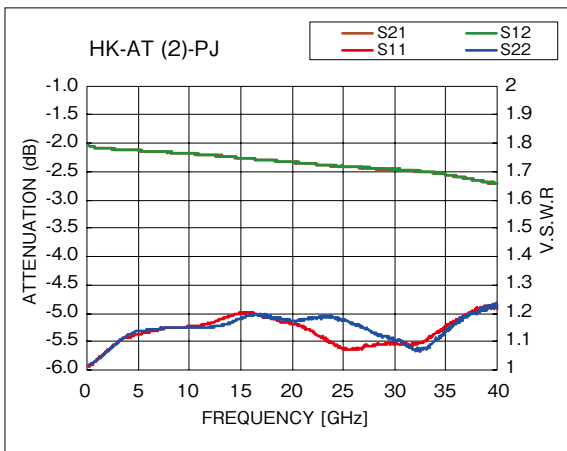
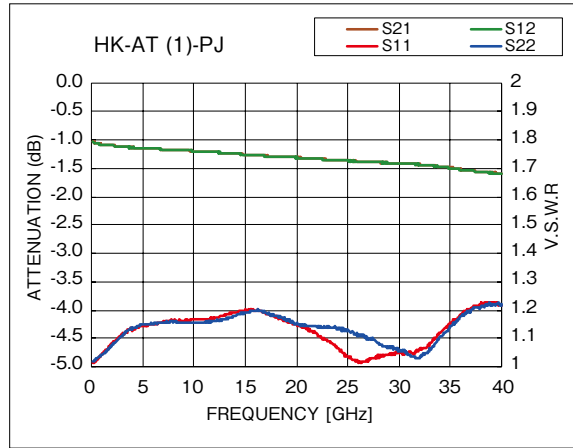
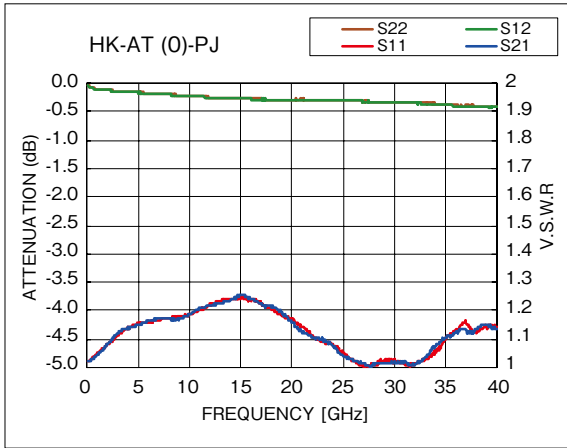

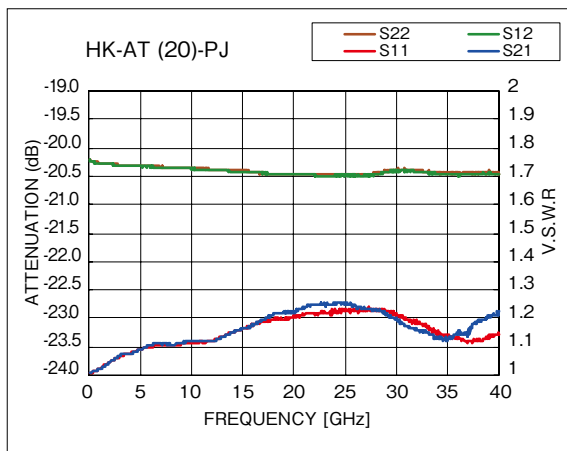
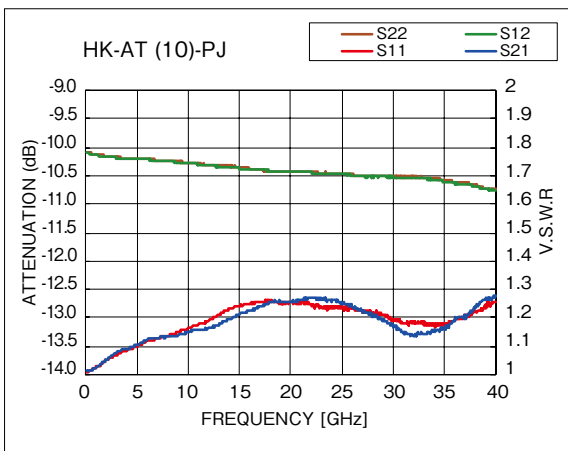
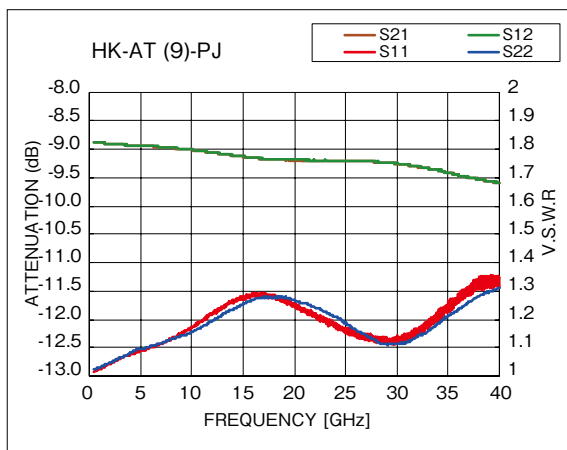
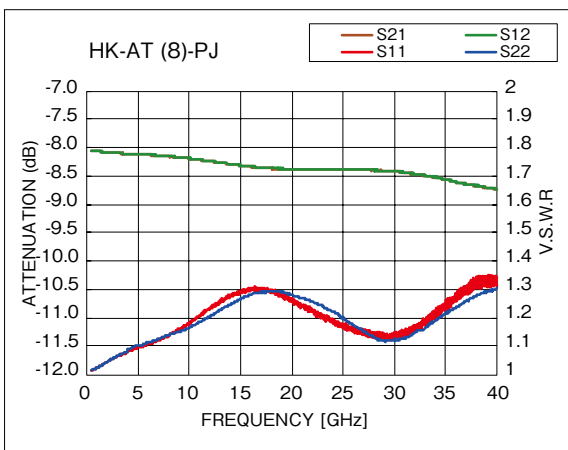
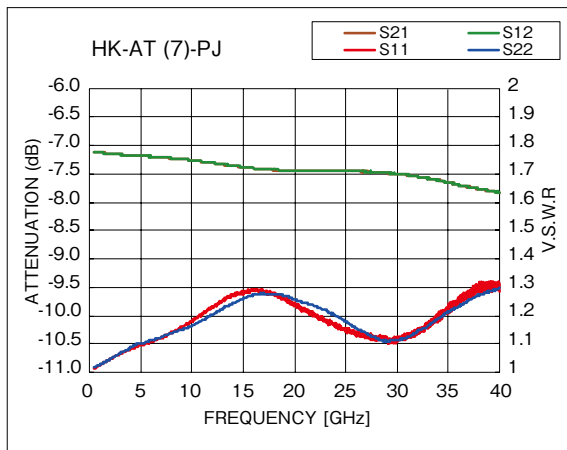
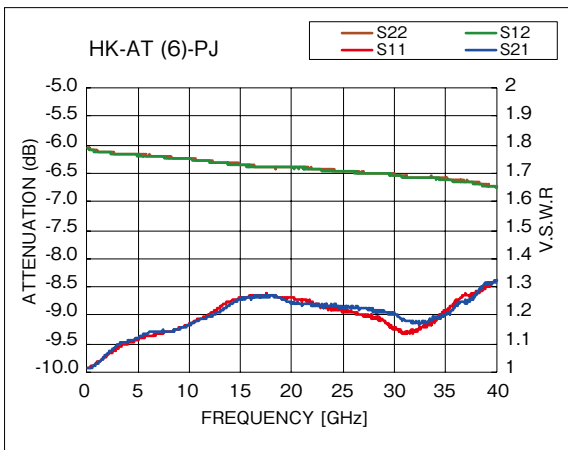

Precautions

1. The diameter of the center contact pin is only 0.92mm.
Please handle with care. When mating the attenuator with the corresponding connector, rotate the hex part only.
2. When mating the attenuator, if any dust is found on the shell interface, please wipe with alcohol.

While Taking into Consideration

Specifications mentioned in this catalog are reference values.

When considering to order or use this product, please confirm the Drawing and Product Specifications sheets.

Use an appropriate cable when using the connector in combination with cables.

If considering usage of a non-specified cable, please contact your sales representative.

If assembly process is done by jigs & tools which are not identified by Hirose, assurance will not be given.

If considering usage for below mentioned applications, please contact your sales representative.

In cases where the application will demand a high level of reliability, such as automotive, medical instruments, public infrastructure, aerospace/ defense etc. Hirose must review before assurance of reliability can be given.

X-ON Electronics

Largest Supplier of Electrical and Electronic Components

Click to view similar products for [RF Connectors](#) / [Coaxial Connectors](#) category:

Click to view products by [Hirose](#) manufacturer:

Other Similar products are found below :

[8915-1511-000](#) [89674-0827](#) [6002-7051-003](#) [6059674-1](#) [630059-000](#) [M39030/3-01N](#) [6501-1071-002](#) [6769](#) [7002-1541-010](#) [7002-1572-002](#)
[7003-1542-011](#) [7003-1572-002](#) [7004-1512-000](#) [7009-1511-004](#) [7101-1541-010](#) [7101-1571-002](#) [7105-1521-002](#) [7145-1521-002](#) [7203-1571-](#)
[003](#) [7209-1511-011](#) [7210-1511-040](#) [7242-1511-000](#) [73216-2241](#) [73404-2300](#) [7405-1521-005](#) [7405-1521-802](#) [8527](#) [8547](#) [FS11V](#) [877931](#)
[8808-1511-001](#) [9074-9513-000](#) [PL40-36](#) [PL40-5](#) [PL71-9](#) [PL74C-221](#) [9408-1113-000](#) [980-8666-005](#) [1200690078](#) [1-201144-1](#) [120919](#)
[R107003010W](#) [R112186000](#) [R113053000W](#) [R113082097](#) [R113236000](#) [R113240000](#) [R113240097](#) [R114083000](#) [R114670000W](#)