

1.85mm Series

# 1.85mm Coaxial Connectors IEC Standard Compliant

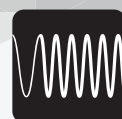

Millimeter Wave



COAX 1.85mm



IEC Standard



## Features

---

1. IEC standard compliant  
1.85mm coaxial  
connector (IEC 61169-32)

2. Supports up to 65GHz  
frequency

3. Board receptacle is  
screw-mounted.

- Provides excellent high frequency performance and consistent mounting quality
- Reusable
- Reduces mounting complexity (No Soldering is required)
- Compatible with various PCB thicknesses

4. 0.085 inch flexible cable  
applicable

5. Attenuators and terminators  
are also available.

6. RoHS2 compliant

## Applications

Data transmission measurement, radio communication equipment, measuring instruments, RF module, radio frequency power amplifier, high speed router, high speed switch, broadcasting equipment, etc.

## Product Specifications

Nominal Characteristic Impedance	50 Ω	Operating Temperature	-55 to +105°C (95% RH Max.)
Rated Frequency	0 to 65GHz	Storage Temperature Range	-55 to +50°C (95% RH Max.)

Items	Specifications	Conditions
Contact Resistance	Center : 4m Ω Max. External : 2m Ω Max.	Measured at 100mA Max.
Insulation Resistance	1000M Ω Min.	Measured at 100V DC
Withstanding Voltage	No breakdown	200V AC for 1 min.
V.S.W.R.*	● HV-P-SF085 V.S.W.R. : 1.35 Max. (0 to 40GHz) V.S.W.R. : 1.45 Max. (40 to 67GHz)	
	● HV-LR-SR2 V.S.W.R. : 1.5 Max. (0 to 65GHz)	
Mating Cycles	Contact resistance Center : 6m Ω Max. External : 4m Ω Max. No broken, cracked, or loose parts	500 cycles
Vibration Resistance	No electrical discontinuity for more than 1 μ s. No broken, cracked, or loose parts	Frequency : 10 to 500Hz, half amplitude : 0.75mm, Acceleration : 196m/s <sup>2</sup> , 12 cycles in each of the 3 axis
Shock Resistance	No electrical discontinuity for more than 1 μ s. No broken, cracked, or loose parts	Acceleration : 980m/s <sup>2</sup> , duration : 6ms, Wave form : half-sine wave, 3 times in each of the 3 axis
Moisture Resistance of Temperature/Humidity Cycle	Insulation resistance : 100M Ω Min. (in a high humidity environment) Insulation resistance : 1000M Ω Min. (in a dry environment) No broken, cracked or loose parts	Left for 10 cycles (240 hours) in an environment with the temperature ranging from -10 to 65°C and the humidity ranging from 90 to 98%.
Temperature Cycle	No broken, cracked or loose parts	5 cycles of the following test series condition : Temperature : -55°C → - → +105°C → - Time : 30 min. → 3 min. → 30 min. → 3 min.
Salt Spray	No considerable corrosion	Continuous 48 hour cycle in 5% salt water solution

(Note) Information contained in this catalog represents general requirements for this Series. Contact us for the drawings and specifications for a specific part number shown.

### \* V.S.W.R. (Voltage Standing Wave Ratio) Measurement System

The above V.S.W.R. specification values were measured using the measurement system shown below.

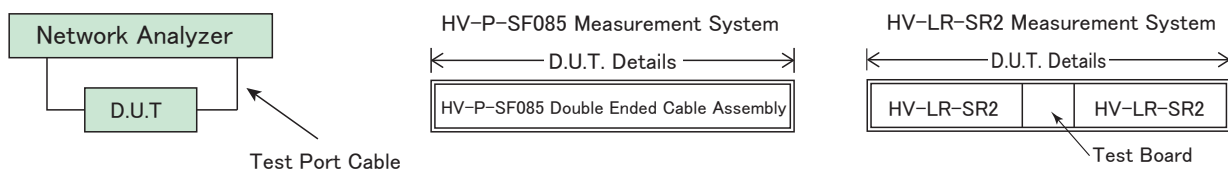

## Materials / Finish

Part	Materials	Finish
Shell	Stainless Steel / Brass	Passivated / Gold Plated / Nickel Plated
Insulator	PTFE Resin / PEI Resin	-
Contact	Beryllium Copper	Gold Plated

## Product Number Structure

Refer to the chart below when determining the product specifications from the product number.

### ■ Plug

**HV - 2P - IW - A - 6IN**

①

②

③

④

① Series Name	HV	③ Cable Type	SF085 : 0.085 inch, Flexible Cable IW : 0.085 inch, Flexible Cable
② Connector Type	P : Straight Plug 2P : Double-ended Straight Plug Cable Assembly	④ Total Length (inch)	6, 12, 24, 36, 48 inch

### ■ Receptacle

**HV - LR - SR2 (##)**

①

②

③

④

① Series Name	HV	③ Board Mounting Method	PCB Screw Mounting
② Connector Type	End Launch Receptacle	④ Attached Screw	(00) : - (11) : 0-80UNF 1/4 inch (12) : 0-80UNF 3/16 inch

## Functional Diagram

### Plug Side

- Straight Plug  
HV-P-SF085



### Receptacle Side

- PCB End Launch Receptacle  
(For High Speed Transmission Evaluation Board Ports)  
HV-LR-SR2



### Adapter

- Conversion Adapter

- SMPM Jack—1.85mm Jack  
SMPMJ-HVJ



- SMPM Plug—1.85mm Plug  
SMPMP(FD)-HVP  
SMPMP(SB)-HVP



### Fixed Attenuators

- Plug—Jack

- HV-AT(##)-PJ  
## : 0, 1, 2, 3, 4, 5, 6, 7, 8, 9, 10, 20dB



### Non-reflective Terminator

- Plug

- HV-TMP(40)  
HV-TMP-1



## Plug

Please contact Hirose for assembly of cables.

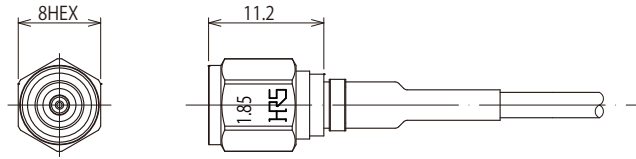

Part No.	HRS No.	Purchase Unit
HV-P-SF085	CL0338-0089-0-00	20pcs per bag

## Cable Assembly (HV Straight Plug - HV Straight Plug)

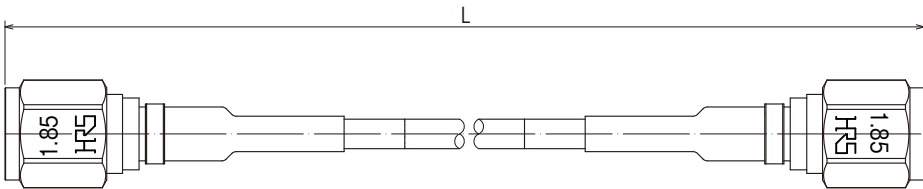
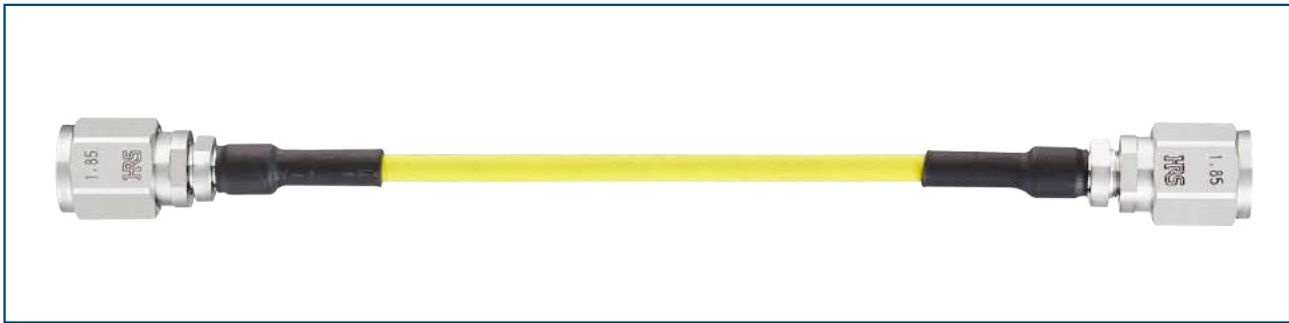

Part No.	HRS No.	Cable Assembly Length L : inch	Cable Assembly Length L : mm	Purchase Unit
HV-2P-IW-A-6IN	CL0321-6633-0-01	6 ± 0.16	152.4 ± 4	20pcs per bag
HV-2P-IW-A-12IN	CL0321-6633-0-02	12 ± 0.32	304.8 ± 8	
HV-2P-IW-A-24IN	CL0321-6633-0-03	24 ± 0.48	609.6 ± 12	
HV-2P-IW-A-36IN	CL0321-6633-0-04	36 ± 0.48	914.4 ± 12	10pcs per bag
HV-2P-IW-A-48IN	CL0321-6633-0-05	48 ± 0.71	1219.2 ± 18	

## PCB End Launch Receptacle (For High Speed Transmission Evaluation Board Ports)

This product is a solderless mounted connector for prototype evaluation of high speed transmission boards. It is not recommended for use in actual commercial equipment.

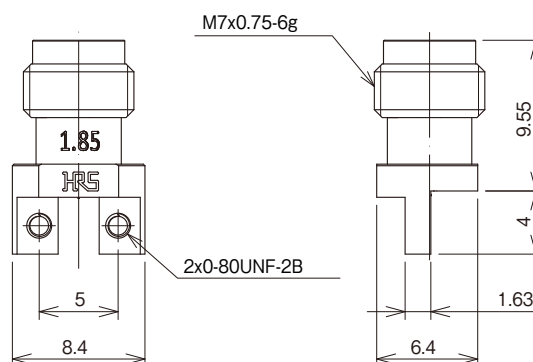

Part No.	HRS No.	Attached Screw	Purchase Unit
HV-LR-SR2	CL0338-0018-0-00	-	20pcs per bag
HV-LR-SR2(11)	CL0338-0018-0-11	0-80UNF 1/4 inch	
HV-LR-SR2(12)	CL0338-0018-0-12	0-80UNF 3/16 inch	

### ◆Frequency Characteristics (TYPICAL)

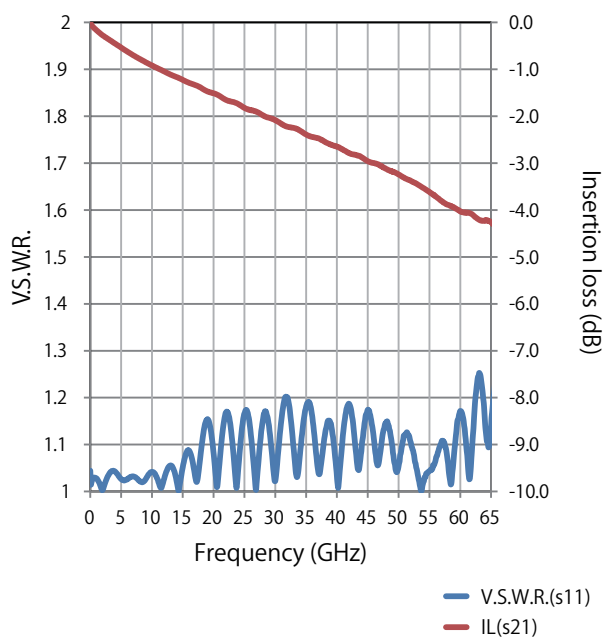

\*Signal line length between both connector ends : 25mm

## Conversion Adapter

### HV Conversion Adapter (Mated Portion : SMPM Side : Jack, HV Side : Jack)

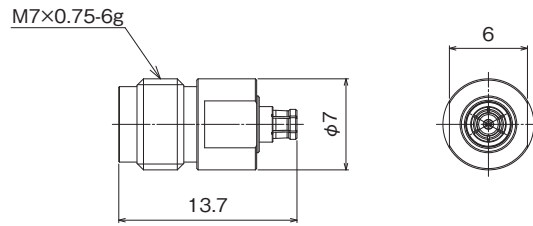

Part No.	HRS No.	Purchase Unit
SMPMJ-HVJ	CL0311-0421-7-00	20pcs per bag

### HV Conversion Adapter (Mated Portion : SMPM Side : Plug, HV Side : Plug)

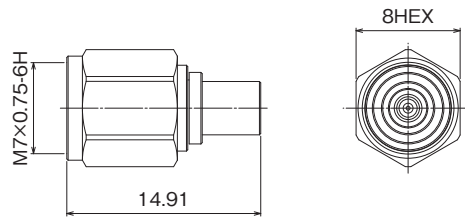

Part No.	HRS No.	Purchase Unit
SMPMP(FD)-HVP	CL0311-0419-5-00	20pcs per bag
SMPMP(SB)-HVP	CL0311-0420-4-00	



## Precautions

1. The diameter of the center contact pin is only 0.511mm.  
Please handle with care. When mating the component with the corresponding connector, rotate the hex part only.
2. If any dust is found on the shell interface when mating the components, please wipe with alcohol.

## While Taking into Consideration

Specifications mentioned in this catalog are reference values.

When considering to order or use this product, please confirm the Drawing and Product Specifications sheets.

Use an appropriate cable when using the connector in combination with cables.

If considering usage of a non-specified cable, please contact your sales representative.

If assembly process is done by jigs & tools which are not identified by Hirose, assurance will not be given.

If considering usage for below mentioned applications, please contact your sales representative.

In cases where the application will demand a high level of reliability, such as automotive, medical instruments, public infrastructure, aerospace/ defense etc. Hirose must review before assurance of reliability can be given.

1.85mm-TM Series

1.85mm Coaxial Connectors

IEC Standard Compliant/Non-Reflective Terminator

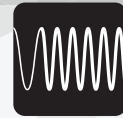

Millimeter Wave



COAX 1.85mm

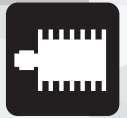

Terminator



## Features

---

1. Non-reflective Terminator  
Supporting 0 to 65GHz
2. Small Size, Light Weight
3. Low V.S.W.R. & High  
Reliability
4. IEC Standard Compliant  
1.85mm Coaxial Terminator  
(IEC 61169-32)

## Applications

Optical transmission devices, data transmission measurement, radio communication equipment, measuring instruments, other high frequency devices, etc.

## Product Specifications

Nominal Characteristic Impedance	50 $\Omega$	Operating Temperature	-10 to +65°C
Rated Frequency	0 to 67GHz	Operating Relative Humidity	95% RH Max.
Power	0.5W CW (+65°C)		

(Note) Information contained in this catalog represents general requirements for this Series. Contact us for the drawings and specifications for a specific part number shown.

## Materials / Finish

Part	Materials	Finish
Shell	Stainless Steel / Brass	Passivated / Gold Plated
Insulator	PTFE Resin	-
Male Contact	Brass	Gold Plated
Coupling	Stainless Steel	Passivated
Resistive Element	Metal Film	-

## Product Number Structure

Refer to the chart below when determining the product specifications from the product number.

### HV - TM P (40)

①      ②      ③

① Series Name	HV	② TM	Non-Reflective Terminator
		③ Connector Type	P : Plug Type

## Terminator

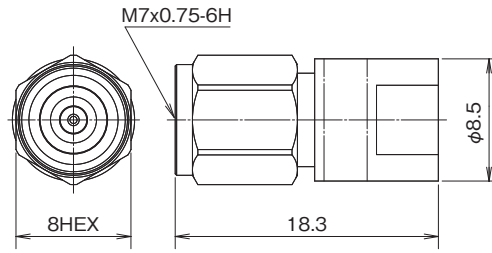

Part No.	HRS No.	Purchase Unit
HV-TMP(40)	CL0353-0146-6-40	1pc per box

### V.S.W.R. (Max.)

0 to 50GHz	50 to 67GHz
1.3	1.4

### ◆ Frequency Characteristics (TYPICAL)

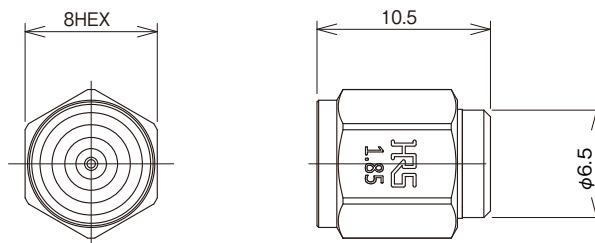
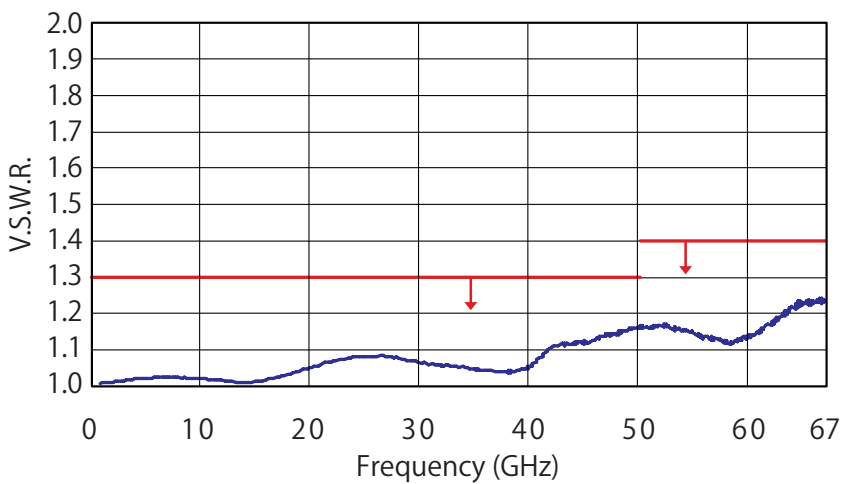

Part No.	HRS No.	Purchase Unit
HV-TMP-1	CL0353-0025-0-00	1pc per bag

### V.S.W.R. (Max.)

0 to 20GHz	20 to 60GHz	60 to 65GHz
1.15	1.25	1.35

## Precautions

1. The diameter of the center contact pin is only 0.511mm.  
Please handle with care. When mating the component with the corresponding connector, rotate the hex part only.
2. If any dust is found on the shell interface when mating the components, please wipe with alcohol.

## While Taking into Consideration

Specifications mentioned in this catalog are reference values.

When considering to order or use this product, please confirm the Drawing and Product Specifications sheets.

Use an appropriate cable when using the connector in combination with cables.

If considering usage of a non-specified cable, please contact your sales representative.

If assembly process is done by jigs & tools which are not identified by Hirose, assurance will not be given.

If considering usage for below mentioned applications, please contact your sales representative.

In cases where the application will demand a high level of reliability, such as automotive, medical instruments, public infrastructure, aerospace/ defense etc. Hirose must review before assurance of reliability can be given.

1.85mm-AT Series

# 1.85mm Coaxial Connectors IEC Standard Compliant/Fixed Attenuator

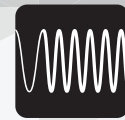

Millimeter Wave



COAX 1.85mm



Attenuator



## Features

---

1. Fixed Attenuators Supporting  
0 to 67GHz  
(0, 1, 2, 3, 4, 5, 6, 7, 8,  
9, 10, 20dB)
2. Small Size, Light Weight
3. Unique internal spring  
connection for robustness  
and excellence impedance  
matching even with  
temperature change.
4. Low V.S.W.R. & High  
Reliability
5. IEC Standard Compliant  
1.85mm Coaxial Actuator  
(IEC 61169-32)

## Applications

Optical transmission devices, data transmission measurement, radio communication equipment, measuring instruments, other high frequency devices, etc.



## Product Specifications

Nominal Characteristic Impedance	50 $\Omega$	Operating Temperature	-10 to +65°C
Rated Frequency	0 to 67GHz	Operating Relative Humidity	95% RH or less
Power	1W CW (+65°C)		

(Note) Information contained in this catalog represents general requirements for this Series. Contact us for the drawings and specifications for a specific part number shown.

## Materials / Finish

Part	Materials	Finish
Shell	Stainless Steel	Passivated
Insulator	PTFE Resin	-
Male Contact	Brass	Gold Plated
Female Contact	Beryllium Copper	Gold Plated
Coupling	Stainless Steel	Passivated
Resistive Element	Metal Film	-

## Product Number Structure

Refer to the chart below when determining the product specifications from the product number.

### HV - AT (##) - PJ

①      ②      ③      ④

① Series Name	HV	③ Attenuation	(Ex.) (0) : 0dB (Through) (3) : 3dB (10) : 10dB
② AT	Fixed Attenuator	④ Connector Type	PJ : Plug Jack

## Attenuator

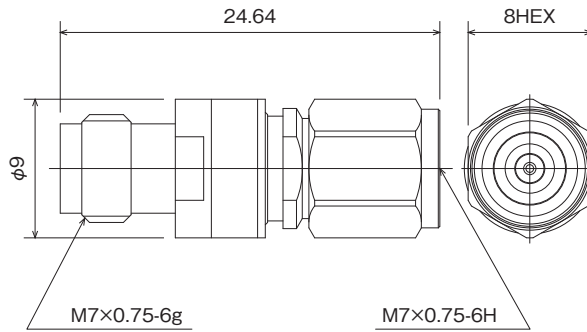

Part No.	HRS No.	Attenuation (dB)				Voltage Standing Wave Ratio (V.S.W.R.)(Max.)			
		0 to 18GHz	18 to 26.5GHz	26.5 to 40GHz	40 to 67GHz	0 to 18GHz	18 to 26.5GHz	26.5 to 40GHz	40 to 67GHz
HV-AT(0)-PJ	CL0354-0244-1-00	$0^{+0.4}$	$0^{+0.5}$	$0^{+0.8}$	$0^{+1.0}$	1.4		1.55	
HV-AT(1)-PJ	CL0354-0288-0-00	$1^{+0.7}$	$1^{+0.8}$	$1^{+1.0}$	$1^{+1.6}$	1.35	1.4		
HV-AT(2)-PJ	CL0354-0289-0-00	$2^{+0.7}$	$2^{+0.8}$	$2^{+1.0}$	$2^{+1.6}$				
HV-AT(3)-PJ	CL0354-0245-4-00	$3^{+0.6}$	$3^{+0.7}$	$3^{+0.9}$	$3^{+1.5}$	1.4			
HV-AT(4)-PJ	CL0354-0300-0-00	$4^{+0.6}$	$4^{+0.7}$	$4^{+0.9}$	$4^{+1.6}$				
HV-AT(5)-PJ	CL0354-0301-0-00	$5^{+0.7}$	$5^{+0.8}$	$5^{+1.0}$	$5^{+1.8}$				
HV-AT(6)-PJ	CL0354-0246-7-00	$6^{+0.7}$	$6^{+0.8}$	$6^{+0.9}$	$6^{+1.7}$				
HV-AT(7)-PJ	CL0354-0302-0-00	$7^{+0.9}$	$7^{+1.0}$	$7^{+1.2}$	$7^{+2.0}$			1.6	
HV-AT(8)-PJ	CL0354-0303-0-00	$8^{+0.9}$	$8^{+1.0}$	$8^{+1.2}$	$8^{+1.8}$				
HV-AT(9)-PJ	CL0354-0304-0-00	$9^{+0.9}$	$9^{+1.0}$	$9^{+1.2}$	$9^{+1.8}$				
HV-AT(10)-PJ	CL0354-0247-0-00	$10 \pm 0.7$	$10^{+0.8}$	$10^{+1.0}$	$10^{+2.1}$				
HV-AT(20)-PJ	CL0354-0248-2-00	$20 \pm 1.0$	$20^{+1.2}$	$20^{+1.4}$	$20^{+1.6}$				

Purchase Unit : 1pc per box

## Frequency Characteristics (TYPICAL)

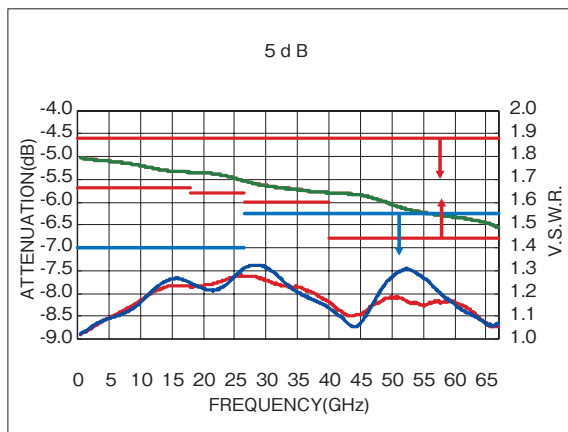
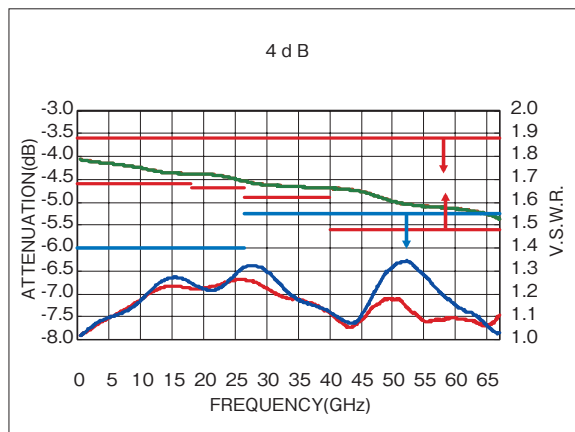
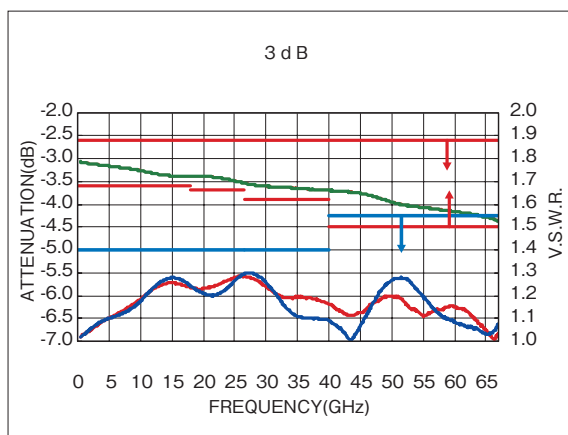
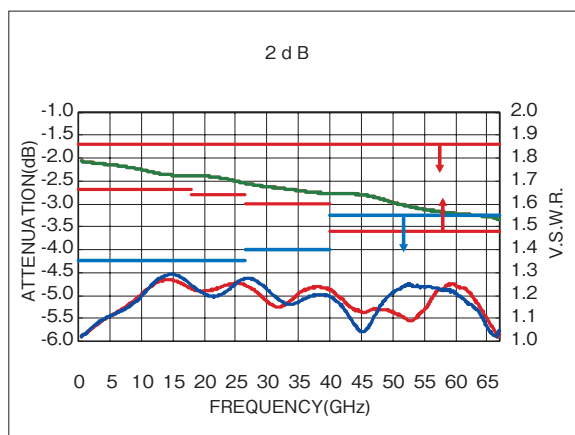
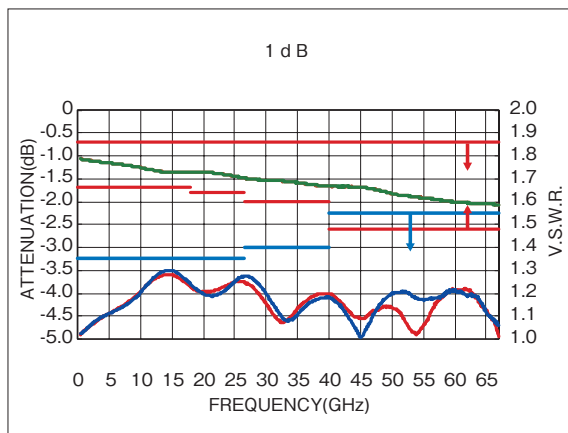
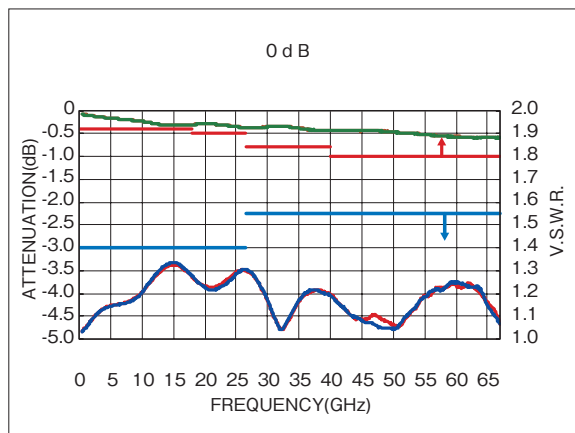

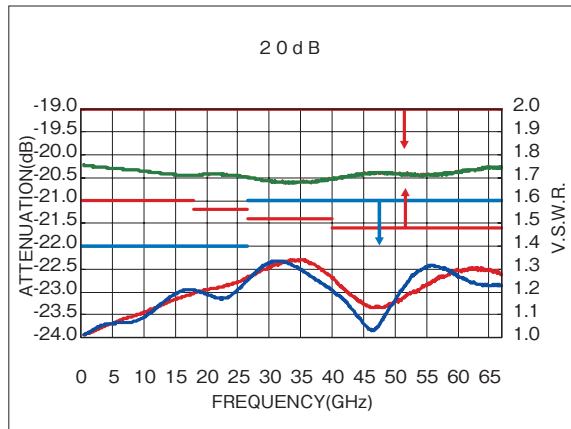
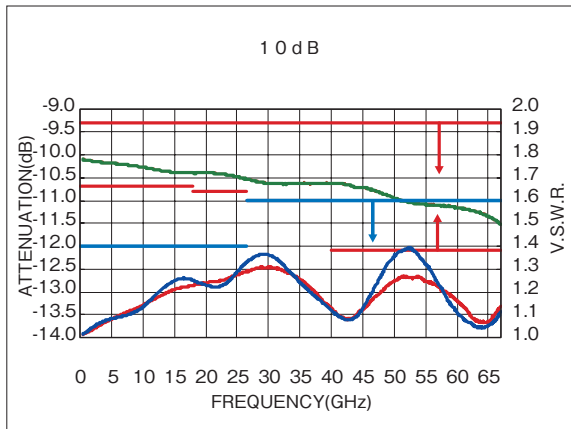
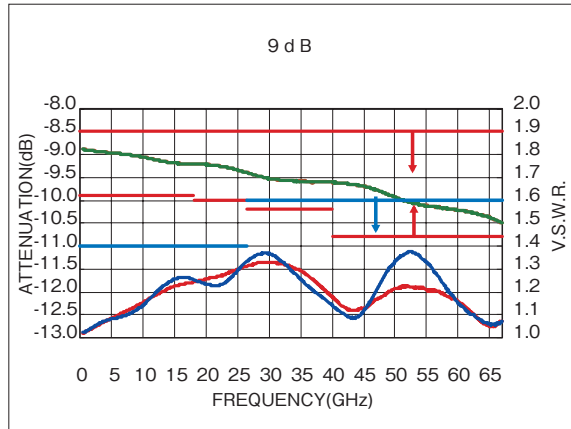
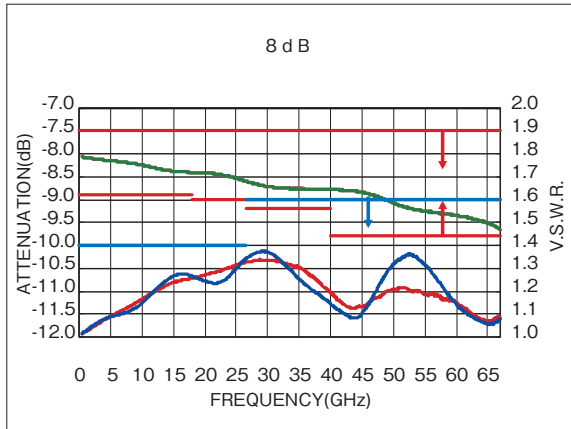
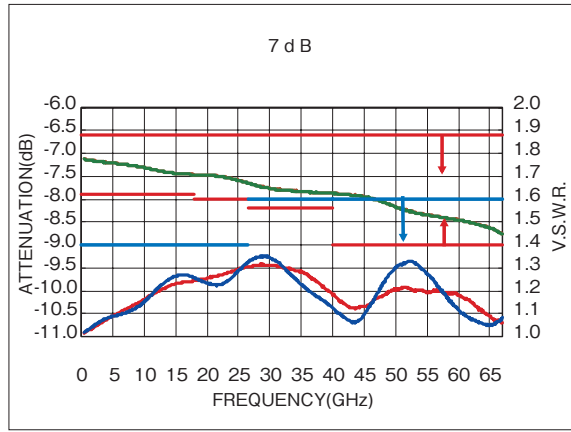
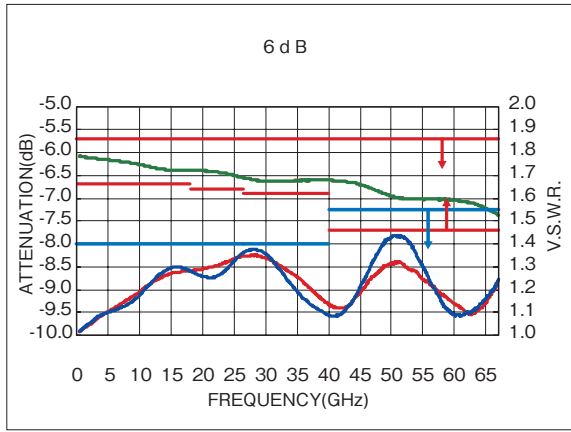

## Precautions

1. The diameter of the center contact pin is only 0.511mm.  
Please handle with care. When mating the component with the corresponding connector, rotate the hex part only.
2. If any dust is found on the shell interface when mating the components, please wipe with alcohol.

## While Taking into Consideration

Specifications mentioned in this catalog are reference values.

When considering to order or use this product, please confirm the Drawing and Product Specifications sheets.

Use an appropriate cable when using the connector in combination with cables.

If considering usage of a non- specified cable, please contact your sales representative.

If assembly process is done by jigs & tools which are not identified by Hirose, assurance will not be given.

If considering usage for below mentioned applications, please contact your sales representative.

In cases where the application will demand a high level of reliability, such as automotive, medical instruments, public infrastructure, aerospace/ defense etc. Hirose must review before assurance of reliability can be given.

## X-ON Electronics

Largest Supplier of Electrical and Electronic Components

*Click to view similar products for [RF Connectors / Coaxial Connectors](#) category:*

*Click to view products by [Hirose](#) manufacturer:*

Other Similar products are found below :

[8915-1511-000](#) [89674-0827](#) [6002-7051-003](#) [6059674-1](#) [630059-000](#) [M39030/3-01N](#) [6501-1071-002](#) [6769](#) [7002-1541-010](#) [7002-1572-002](#)  
[7003-1542-011](#) [7003-1572-002](#) [7004-1512-000](#) [7009-1511-004](#) [7101-1541-010](#) [7101-1571-002](#) [7105-1521-002](#) [7145-1521-002](#) [7203-1571-](#)  
[003](#) [7209-1511-011](#) [7210-1511-040](#) [7242-1511-000](#) [73216-2241](#) [73404-2300](#) [7405-1521-005](#) [7405-1521-802](#) [8527](#) [8547](#) [FS11V](#) [877931](#)  
[8808-1511-001](#) [9074-9513-000](#) [PL40-36](#) [PL40-5](#) [PL71-9](#) [PL74C-221](#) [9408-1113-000](#) [980-8666-005](#) [1200690078](#) [1-201144-1](#) [120919](#)  
[R107003010W](#) [R112186000](#) [R113053000W](#) [R113082097](#) [R113236000](#) [R113240000](#) [R113240097](#) [R114083000](#) [R114670000W](#)