

2.54mm Pitch Bottom Entry Type Connector

MDF7 Series

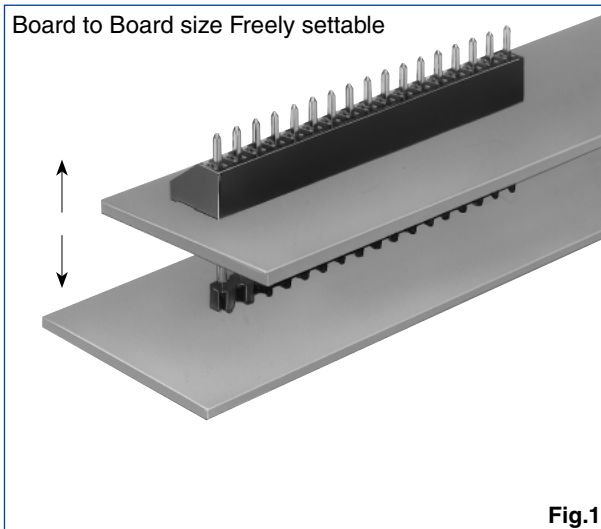
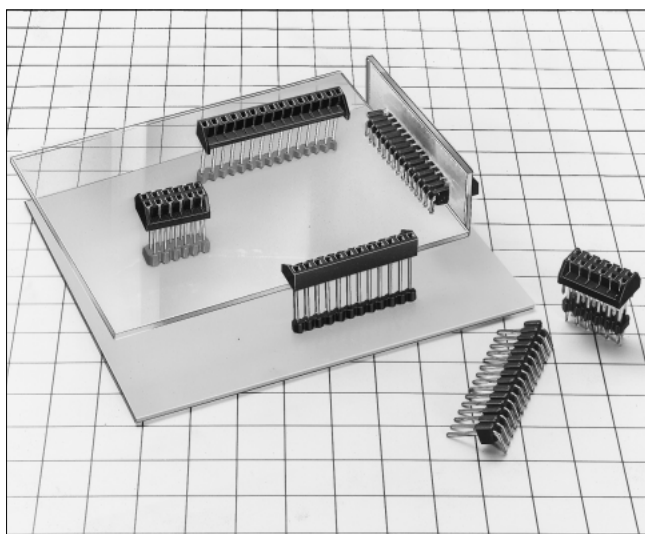

■ Features

1. Board to Board Size Freely Settable

The board to board size can be set at infinite stages, according to the header pin through type structure and the diverse header variation.

The board to board size can be set at infinite stages.

2. Integrity of Parts Mounted Surface

The parts mounted surface on two boards aren't face each other, and can be oriented in the same direction.

3. Wide Variation

Single-row product, double-row product, tin plated and gold plated products are lined up. In addition, the header to correspond to the board to board size are prepared. Concerning board to board size, other products can be provided, in addition to products in this catalog. Please contact HRS company as required.

Product Specifications

Rating	Current rating: 3A	Operating Temperature Range: -35°C to +85°C(Note 1)	Storage Temperature Range: -10°C to +60°C(Note 2)
	Voltage rating: 250V AC	Operating Humidity Range: 40% to 80%	Storage Humidity Range: 40% to 70%(Note 2)
Item	Specification	Condition	
1. Insulation Resistance	1000M Ω min.	500V DC	
2. Withstanding voltage	No flashover or insulation breakdown.	650V AC/1 minute	
3. Contact Resistance	30m Ω max.	100mA	
4. Single Insertion/Extraction Force	MIN 0.4N(40gf), MAX 4.4N(450gf)	Measured by the square steel pin with 0.635±0.002mm	
5. Vibration	No electrical discontinuity of 10 μs or more	Frequency: 10 to 55 Hz, single amplitude of 0.75 mm, 2 hours in each of the 3 directions.	
6. Humidity (Steady state)	Contact resistance: 30m Ω max.	96 hours at temperature of	
7. Temperature Cycle	Contact resistance: 30m Ω max. Insulation resistance: 1000M Ω min.	(-55°C: 30 minutes, 5 to 35°C: 10 minutes 85°C: 30 minutes, 5 to 35°C: 10 minutes) 5cycles	
8. Durability (Mating/un-mating)	Contact resistance: 30m Ω max.	Tin plating : 30 cycles Gold plating : 50 cycles	
9. Resistance to Soldering heat	No deformation of components affecting performance.	Flow: 260°C for 10 seconds Manual soldering: 350°C for 3 seconds	

Note 1: Includes temperature rise caused by current flow.

Note 2: The term "storage" refers to products stored for long period of time prior to mounting and use. Operating Temperature Range and Humidity range covers non conducting condition of installed connectors in storage, shipment or during transportation.

Material

Product	Part	Material	Finish	Remarks
Receptacle	Insulator	Polyamide	Black	UL94V-0
	Contact	Phosphor bronze	Tin plated or gold plated	————
Pin Header	Insulator	PBT	Main unit: Black/Locator: Gray	UL94V-0
	Contact	Brass	Tin plated or gold plated	————

Ordering Information

MDF7 - * S - 2.54 DSA ()**

① ② ③ ④ ⑤ ⑥

① Series Name: MDF7	⑥ Receptacle (55): Tin plated (100 pcs/pack) (56): Gold plated (100 pcs/pack) Pin Header P (55) : Tin plated (100 pcs/pack) (01) : Gold plated (100 pcs/pack) DP (55) : Tin plated (100 pcs/pack) Blank : Gold plated (100 pcs/pack)
② Number of contacts: 3 to 46	
③ Connector Type S : Single row receptacle D : Double row receptacle P : Single row pin header DP: Double row pin header	
④ Contact Pitch : 2.54mm	
⑤ Contact type DSA : Straight through hole DS : Right Angle through hole	

Single Row Receptacle

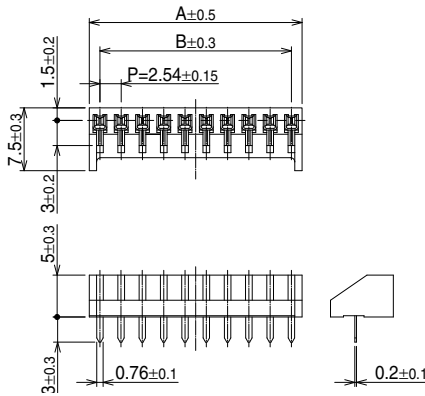
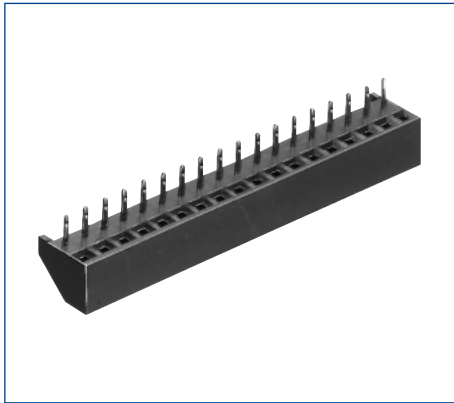

[Specific No.] - * *, (* *)
 (55) : Tin plated
 (56) : Gold plated

Unit: mm

Part No.	HRS No.	No. of Contacts	A	B	RoHS	Part No.	HRS No.	No. of Contacts	A	B	RoHS
MDF7-3S-2.54DSA(**)	547-0355-0 **	3	7.62	5.08	Yes	MDF7-15S-2.54DSA(**)	547-0012-4 **	15	38.10	35.56	Yes
MDF7-5S-2.54DSA(**)	547-0112-9 **	5	12.70	10.16		MDF7-16S-2.54DSA(**)	547-0141-7 **	16	40.64	38.10	
MDF7-6S-2.54DSA(**)	547-0129-1 **	6	15.24	12.70		MDF7-17S-2.54DSA(**)	547-0142-0 **	17	43.18	40.64	
MDF7-7S-2.54DSA(**)	547-0135-4 **	7	17.78	15.24		MDF7-18S-2.54DSA(**)	547-0013-7 **	18	45.72	43.18	
MDF7-8S-2.54DSA(**)	547-0136-7 **	8	20.32	17.78		MDF7-19S-2.54DSA(**)	547-0143-2 **	19	48.26	45.72	
MDF7-9S-2.54DSA(**)	547-0137-0 **	9	22.86	20.32		MDF7-20S-2.54DSA(**)	547-0051-6 **	20	50.80	48.26	
MDF7-10S-2.54DSA(**)	547-0038-8 **	10	25.40	22.86		MDF7-21S-2.54DSA(**)	547-0144-5 **	21	53.34	50.80	
MDF7-11S-2.54DSA(**)	547-0138-2 **	11	27.94	25.40		MDF7-22S-2.54DSA(**)	547-0145-8 **	22	55.88	53.34	
MDF7-12S-2.54DSA(**)	547-0040-0 **	12	30.48	27.94		MDF7-23S-2.54DSA(**)	547-0146-0 **	23	58.42	55.88	
MDF7-13S-2.54DSA(**)	547-0139-5 **	13	33.02	30.48		MDF7-24S-2.54DSA(**)	547-0147-3 **	24	60.96	58.42	
MDF7-14S-2.54DSA(**)	547-0140-4 **	14	35.56	33.02		MDF7-25S-2.54DSA(**)	547-0014-0 **	25	63.50	60.96	

Note: The quantity for delivery is determined 100 pcs/pack. Please order the products per pack.

Double Row Receptacle

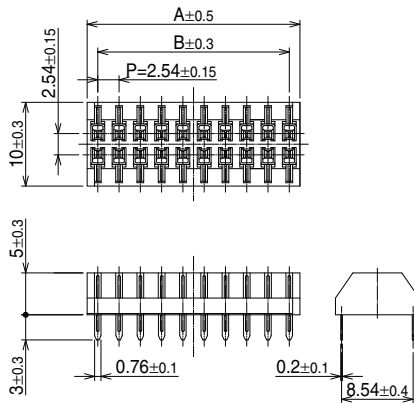
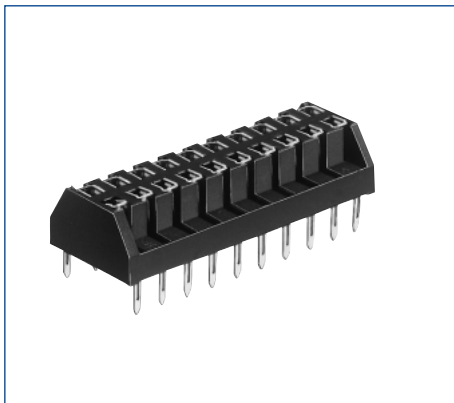

Unit: mm

[Specific No.] - * *, (* *) (Note 2)
 (55) : Tin plated
 (56) : Gold plated

Part No.	HRS No.	No. of Contacts	A	B	RoHS
MDF7-12D-2.54DSA(**)	547-0032-1 **	12	15.24	12.70	Yes
MDF7-14D-2.54DSA(**)	547-0354-8 **	14	17.78	15.24	
MDF7-16D-2.54DSA(**)	547-0363-9 **	16	20.32	17.78	
MDF7-20D-2.54DSA(**)	547-0033-4 **	20	25.40	22.86	
MDF7-22D-2.54DSA(**)	547-0246-5 **	22	27.94	25.40	
MDF7-24D-2.54DSA(**)	547-0244-0 **	24	30.48	27.94	
MDF7-26D-2.54DSA(**)	547-0247-8 **	26	33.02	30.48	
MDF7-30D-2.54DSA(**)	547-0016-5 **	30	38.10	35.56	
MDF7-34D-2.54DSA(**)	547-0227-0 **	34	43.18	40.64	
MDF7-40D-2.54DSA(**)	547-0228-3 **	40	50.80	48.26	
MDF7-46D-2.54DSA(**)	547-0229-6 **	46	58.42	55.88	
MDF7-48D-2.54DSA(**)	547-0060-7 **	48	60.96	58.42	

Note 1: A quantity for delivery is determined 100 pcs/pack. Please order the products per pack.

Single Row Straight Pin Header

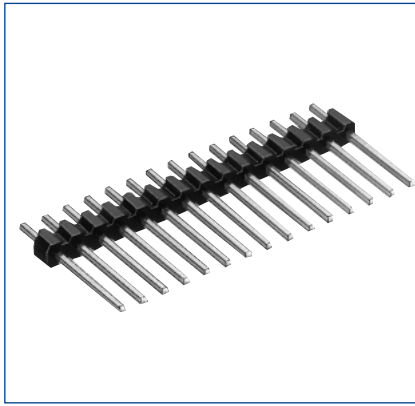

● Board Through-hole Diameter: $\phi 1.0^{+0.1}$

[Specific No.] - * *, (* *)
 (55) : Tin plated
 (01) : Gold plated

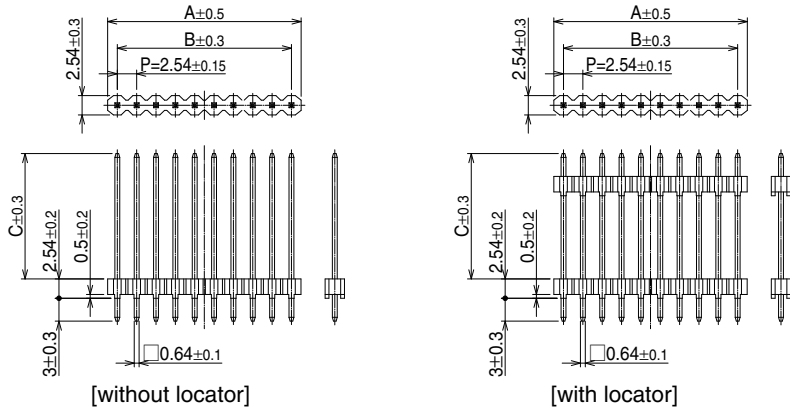

● MDF7 (PCB distance: 2.54 to 5.5mm)

● MDF7B (PCB distance: 2.54 to 12mm)

Unit: mm

Unit: mm

Part No.	HRS No.	No. of Contacts	A	B	C	RoHS	Part No.	HRS No.	No. of Contacts	A	B	C	RoHS
MDF7-3P-2.54DSA(**)	547-0220-1 **	3	7.62	5.08	10	Yes	MDF7B-3P-2.54DSA(**)	547-0304-0 **	3	7.62	5.08	16.46	Yes
MDF7-5P-2.54DSA(**)	547-0113-1 **	5	12.70	10.16			MDF7B-5P-2.54DSA(**)	547-0133-9 **	5	12.70	10.16		
MDF7-6P-2.54DSA(**)	547-0130-0 **	6	15.24	12.70			MDF7B-6P-2.54DSA(**)	547-0131-3 **	6	15.24	12.70		
MDF7-7P-2.54DSA(**)	547-0148-6 **	7	17.78	15.24			MDF7B-7P-2.54DSA(**)	547-0177-4 **	7	17.78	15.24		
MDF7-8P-2.54DSA(**)	547-0149-9 **	8	20.32	17.78			MDF7B-8P-2.54DSA(**)	547-0178-7 **	8	20.32	17.78		
MDF7-9P-2.54DSA(**)	547-0150-8 **	9	22.86	20.32			MDF7B-9P-2.54DSA(**)	547-0179-0 **	9	22.86	20.32		
MDF7-10P-2.54DSA(**)	547-0039-0 **	10	25.40	22.86			MDF7B-10P-2.54DSA(**)	547-0048-1 **	10	25.40	22.86		
MDF7-11P-2.54DSA(**)	547-0151-0 **	11	27.94	25.40			MDF7B-11P-2.54DSA(**)	547-0047-9 **	11	27.94	25.40		
MDF7-12P-2.54DSA(**)	547-0043-8 **	12	30.48	27.94			MDF7B-12P-2.54DSA(**)	547-0041-2 **	12	30.48	27.94		
MDF7-13P-2.54DSA(**)	547-0152-3 **	13	33.02	30.48			MDF7B-13P-2.54DSA(55)	547-0180-9 55	13	33.02	30.48		
MDF7-14P-2.54DSA(**)	547-0153-6 **	14	35.56	33.02			MDF7B-14P-2.54DSA(55)	547-0181-1 55	14	35.56	33.02		
MDF7-15P-2.54DSA(**)	547-0018-0 **	15	38.10	35.56			MDF7B-15P-2.54DSA(**)	547-0024-3 **	15	38.10	35.56		
MDF7-16P-2.54DSA(**)	547-0111-6 **	16	40.64	38.10			MDF7B-16P-2.54DSA(**)	547-0182-4 **	16	40.64	38.10		
MDF7-17P-2.54DSA(**)	547-0154-9 **	17	43.18	40.64			MDF7B-17P-2.54DSA(55)	547-0183-7 55	17	43.18	40.64		
MDF7-18P-2.54DSA(**)	547-0022-8 **	18	45.72	43.18			MDF7B-18P-2.54DSA(55)	547-0025-6 55	18	45.72	43.18		
MDF7-19P-2.54DSA(**)	547-0155-1 **	19	48.26	45.72			MDF7B-19P-2.54DSA(55)	547-0184-0 55	19	48.26	45.72		
MDF7-20P-2.54DSA(**)	547-0123-5 **	20	50.80	48.26			MDF7B-20P-2.54DSA(**)	547-0052-9 **	20	50.80	48.26		
MDF7-21P-2.54DSA(**)	547-0156-4 **	21	53.34	50.80			MDF7B-21P-2.54DSA(55)	547-0185-2 55	21	53.34	50.80		
MDF7-22P-2.54DSA(**)	547-0157-7 **	22	55.88	53.34			MDF7B-22P-2.54DSA(55)	547-0186-5 55	22	55.88	53.34		
MDF7-23P-2.54DSA(**)	547-0158-0 **	23	58.42	55.88			MDF7B-23P-2.54DSA(55)	547-0066-3 55	23	58.42	55.88		
MDF7-24P-2.54DSA(**)	547-0159-2 **	24	60.96	58.42			MDF7B-24P-2.54DSA(55)	547-0067-6 55	24	60.96	58.42		
MDF7-25P-2.54DSA(**)	547-0023-0 **	25	63.50	60.96			MDF7B-25P-2.54DSA(55)	547-0026-9 55	25	63.50	60.96		

Note 1: PCB distance in the above table represents the case where the 1.6mm thickness board is used.

Note 2: The quantity for delivery is determined 100 pcs/pack. Please order the products per pack.

●MDF7P (PCB distance: 2.54 to 8mm)

●MDF7C (PCB distance: 5.08 to 15mm, with Locator)

Unit: mm

Unit: mm

Part No.	HRS No.	No. of Contacts	A	B	C	RoHS	Part No.	HRS No.	No. of Contacts	A	B	C	RoHS
MDF7P-3P-2.54DSA(01)	547-0462-0 01	3	7.62	5.08			MDF7C-3P-2.54DSA(**)	547-0489-7 **	3	7.62	5.08		
MDF7P-5P-2.54DSA(**)	547-0511-4 **	5	12.70	10.16			MDF7C-5P-2.54DSA(**)	547-0344-4 **	5	12.70	10.16		
MDF7P-6P-2.54DSA(**)	547-0513-0 **	6	15.24	12.70			MDF7C-6P-2.54DSA(55)	547-0268-8 55	6	15.24	12.70		
MDF7P-7P-2.54DSA(**)	————	7	17.78	15.24			MDF7C-7P-2.54DSA(**)	547-0378-6 **	7	17.78	15.24		
MDF7P-8P-2.54DSA(55)	547-0514-2 55	8	20.32	17.78			MDF7C-8P-2.54DSA(55)	547-0375-8 55	8	20.32	17.78		
MDF7P-9P-2.54DSA(**)	————	9	22.86	20.32			MDF7C-9P-2.54DSA(55)	547-0506-4 55	9	22.86	20.32		
MDF7P-10P-2.54DSA(55)	547-0360-0 55	10	25.40	22.86			MDF7C-10P-2.54DSA(55)	547-0191-5 55	10	25.40	22.86		
MDF7P-11P-2.54DSA(**)	————	11	27.94	25.40			MDF7C-11P-2.54DSA(55)	547-0376-0 55	11	27.97	25.40		
MDF7P-12P-2.54DSA(55)	547-0345-7 55	12	30.48	27.94			MDF7C-12P-2.54DSA(**)	547-0475-2 **	12	30.48	27.94		
MDF7P-13P-2.54DSA(**)	————	13	33.02	30.48			MDF7C-13P-2.54DSA(55)	547-0401-6 55	13	33.02	30.48		
MDF7P-14P-2.54DSA(55)	547-0385-1 55	14	35.56	33.02	12.5	Yes	MDF7C-14P-2.54DSA(55)	547-0380-8 55	14	35.56	33.02	19.46	Yes
MDF7P-15P-2.54DSA(55)	547-0230-5 55	15	38.10	35.56			MDF7C-15P-2.54DSA(55)	547-0187-8 55	15	38.10	35.56		
MDF7P-16P-2.54DSA(55)	547-0346-0 55	16	40.64	38.10			MDF7C-16P-2.54DSA(**)	————	16	40.64	38.10		
MDF7P-17P-2.54DSA(**)	————	17	43.18	40.64			MDF7C-17P-2.54DSA(**)	————	17	43.18	40.64		
MDF7P-18P-2.54DSA(**)	————	18	45.72	43.18			MDF7C-18P-2.54DSA(55)	547-0029-7 55	18	45.72	43.18		
MDF7P-19P-2.54DSA(55)	547-0347-2 55	19	48.26	45.72			MDF7C-19P-2.54DSA(55)	547-0361-3 55	19	48.26	45.72		
MDF7P-20P-2.54DSA(**)	————	20	50.80	48.26			MDF7C-20P-2.54DSA(**)	547-0198-4 **	20	50.80	48.26		
MDF7P-21P-2.54DSA(**)	————	21	53.34	50.80			MDF7C-21P-2.54DSA(**)	————	21	53.34	50.80		
MDF7P-22P-2.54DSA(**)	————	22	55.88	53.34			MDF7C-22P-2.54DSA(**)	————	22	55.88	53.34		
MDF7P-23P-2.54DSA(**)	————	23	58.42	55.88			MDF7C-23P-2.54DSA(55)	547-0909-0 55	23	58.42	55.88		
MDF7P-24P-2.54DSA(**)	————	24	60.96	58.42			MDF7C-24P-2.54DSA(**)	————	24	60.96	58.42		
MDF7P-25P-2.54DSA(55)	547-0348-5 55	25	63.50	60.96			MDF7C-25P-2.54DSA(55)	547-0305-2 55	25	63.50	60.96		

Note 1: PCB distance in the above table represents the case where the 1.6mm thickness board is used.

Note 2: A quantity for delivery is determined 100 pcs/pack. Please order the products per pack.

Note 3: As for the products, which HRS No. is not indicated in the above table, we will correspond to samples, and mass-production according to your demand. Please contact our account executive, as required.

Single-Row Right Angle Pin Header

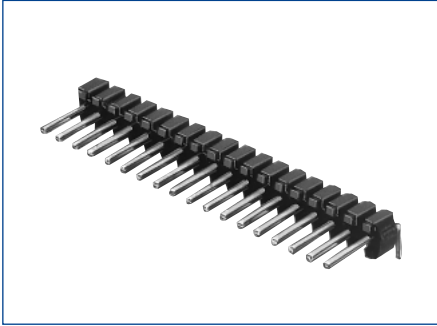

● Board Through-hole Diameter: $\phi 1.0^{+0.1}$

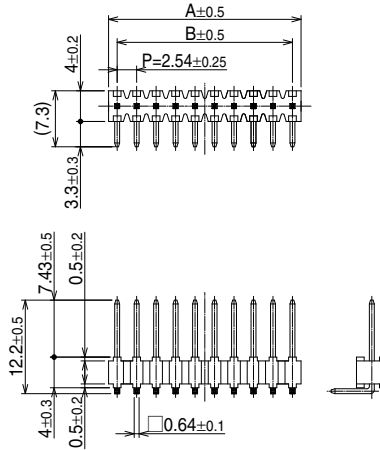

[Specific No.] - * *, (* *)
 (55) : Tin plated
 (56) : Gold plated

Unit: mm

Part No.	HRS No.	No. of Contacts	A	B	RoHS	Part No.	HRS No.	No. of Contacts	A	B	RoHS	
MDF7-5P-2.54DS(**)	547-0160-1 **	5	12.70	10.16	Yes	MDF7-16P-2.54DS(**)	547-0169-6 **	16	40.64	38.10	Yes	
MDF7-6P-2.54DS(**)	547-0161-4 **	6	15.24	12.70		MDF7-17P-2.54DS(**)	547-0170-5 **	17	43.18	40.64		
MDF7-7P-2.54DS(**)	547-0162-7 **	7	17.78	15.24		MDF7-18P-2.54DS(**)	547-0019-3 **	18	45.72	43.18		
MDF7-8P-2.54DS(**)	547-0163-0 **	8	20.32	17.78		MDF7-19P-2.54DS(**)	547-0171-8 **	19	48.26	45.72		
MDF7-9P-2.54DS(**)	547-0164-2 **	9	22.86	20.32		MD7F-20P-2.54DS(**)	547-0172-0 **	20	50.80	48.26		
MDF7-10P-2.54DS(**)	547-0165-5 **	10	25.40	22.86		MDF7-21P-2.54DS(**)	547-0173-3 **	21	53.34	50.80		
MDF7-11P-2.54DS(**)	547-0166-8 **	11	27.94	25.40		MDF7-22P-2.54DS(**)	547-0174-6 **	22	55.88	53.34		
MDF7-12P-2.54DS(**)	547-0116-0 **	12	30.48	27.94		MDF7-23P-2.54DS(**)	547-0175-9 **	23	58.42	55.88		
MDF7-13P-2.54DS(**)	547-0167-0 **	13	33.02	30.48		MDF7-24P-2.54DS(**)	547-0176-1 **	24	60.96	58.42		
MDF7-14P-2.54DS(**)	547-0168-3 **	14	35.56	33.02		MDF7-25P-2.54DS(**)	547-0028-4 **	25	63.50	60.96		
MDF7-15P-2.54DS(**)	547-0027-1 **	15	38.10	35.56								

Note: A quantity for delivery is determined 100 pcs/pack. Please order the products per pack.

Application Pattern and PCB mounting pattern

● When the single-row straight pin header is used

● When the header with locator is used

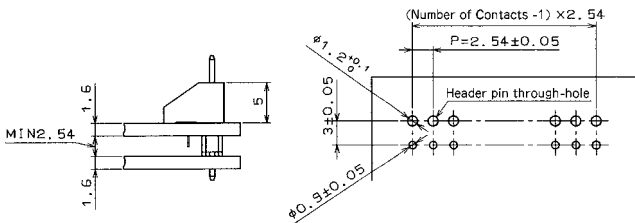

The locator moves as the connector is inserted.

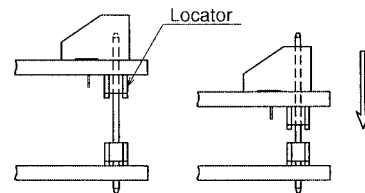

● When the PCB distance is set to MAX

● When the right angle pin header is used

To separate clearance between the boards, the operation limit t is defined as the state where the male pin has passed through the receptacle.

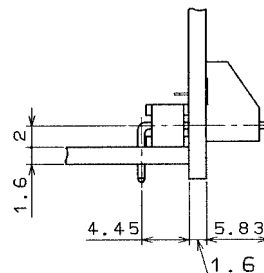
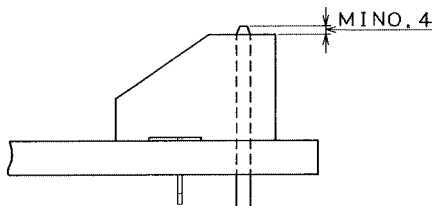

Double-Row Straight Pin Header

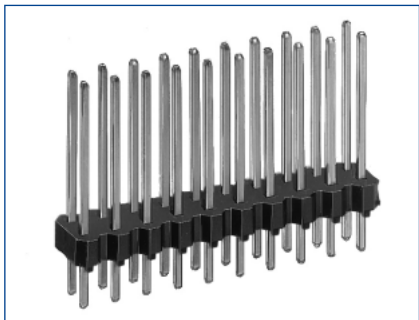

●Board Through-hole Diameter: $\phi 1.0^{+0.1}$

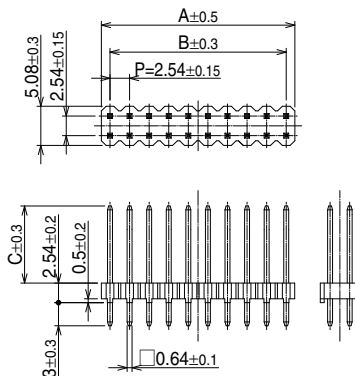

[Specific No.] -** *, (** *)
 (55) : Tin plated
 Blank : Gold plated

●MDF7 (PCB distance: 2.54 to 5.5mm)

●MDF7P (PCB distance: 2.54 to 8mm)

Unit: mm

Unit: mm

Part No.	HRS No.	No. of Contacts	A	B	C	RoHS	Part No.	HRS No.	No. of Contacts	A	B	C	RoHS
MDF7-12DP-2.54DSA(**)	547-0034-7 **	12	15.24	12.70	10	Yes	MDF7P-12DP-2.54DSA(**)	547-0407-2 **	12	15.24	12.70	12.5	Yes
MDF7-14DP-2.54DSA(**)	547-0365-4 **	14	17.78	15.24			MDF7P-14DP-2.54DSA(**)	—	14	17.78	15.24		
MDF7-16DP-2.54DSA(**)	547-0364-1 **	16	20.32	17.78			MDF7P-16DP-2.54DSA(55)	547-0367-0 55	16	20.32	17.78		
MDF7-20DP-2.54DSA(**)	547-0114-4 **	20	25.40	22.86			MDF7P-20DP-2.54DSA(55)	547-0260-6 55	20	25.40	22.86		
MDF7-22DP-2.54DSA(**)	547-0093-6 **	22	27.94	25.40			MDF7P-22DP-2.54DSA(55)	547-0261-9 55	22	27.94	25.40		
MDF7-24DP-2.54DSA(**)	547-0250-2 **	24	30.48	27.94			MDF7P-24DP-2.54DSA(**)	547-0262-1 **	24	30.48	27.94		
MDF7-26DP-2.54DSA(**)	547-0251-5 **	26	33.02	30.48			MDF7P-26DP-2.54DSA(**)	547-0263-4 **	26	33.02	30.48		
MDF7-30DP-2.54DSA(**)	547-0037-5 **	30	38.10	35.56			MDF7P-30DP-2.54DSA(55)	547-0264-7 55	30	38.10	35.56		
MDF7-34DP-2.54DSA(**)	547-0252-8 **	34	43.18	40.64			MDF7P-34DP-2.54DSA(**)	—	34	43.18	40.64		
MDF7-40DP-2.54DSA(**)	547-0253-0 **	40	50.80	48.26			MDF7P-40DP-2.54DSA(00)	547-0917-9 00	40	50.80	48.26		
MDF7-46DP-2.54DSA(**)	547-0254-3 **	46	58.42	55.88			MDF7P-46DP-2.54DSA(**)	—	46	58.42	55.88		

Note 1: PCB distance in the above table represents the state where the 1.6mm thickness board is used.

Note 2: A quantity for delivery is determined 100 pcs/pack. Please order the products per pack.

Note 3: As for the products, which HRS No. is not indicated in the above table, we will correspond to samples, and mass-production according to your demand. Please contact our account executive, as required.

Application Pattern and PCB mounting pattern

●When the double-row straight pin header is used

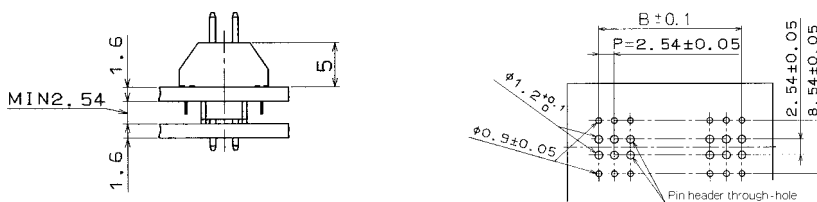

Precautions

1. Recommended Soldering Condition	<p>■Flow Condition by Automatic Soldering Unit Soldering temperature: 255±5°C, Soldering time: within 10 seconds</p> <p>■Manual Soldering Condition Soldering iron temperature: 340±10°C, Soldering time: within 3 seconds</p>
2. Board Masking	<p>If the automatic soldering unit is used, block the pin header through-hole on the receptacle mounted board with the masking tape, etc., and prevent the flux pervasion.</p> <p>In addition, if much flux is adhered so as to affect the contact, please be sure to clean the board.</p>
3. Cleaning Condition	Refer to Nylon Connector Use Hand book.
4. Cautions	<p>■It is impossible to fix the board to the board by the connector only. Please take actions to fix the board without using the connector.</p> <p>■If the board deformation could occur due to vibration, please use the gold plating.</p> <p>■Don't use the connector as the top entry.</p>

USA:

HIROSE ELECTRIC (U.S.A.), INC. HEADQUARTERS
 2688 Westhills Court, Simi Valley, CA 93065-6235
 Phone : +1-805-522-7958
 Fax : +1-805-522-3217
<http://www.hirose.com/us/>

USA:

HIROSE ELECTRIC (U.S.A.), INC. SAN JOSE OFFICE
 3255 Scott Boulevard, Building 7, Suite 101
 Santa Clara, CA 95054
 Phone : +1-408-253-9640
 Fax : +1-408-253-9641
<http://www.hirose.com/us/>

USA:

HIROSE ELECTRIC (U.S.A.), INC. CHICAGO OFFICE
 580 Waters Edge Lane, Suite 205 Lombard IL
 60148
 Phone : +1-630-282-6706
 Mail : inquiries@hirose.com
<http://www.hirose.com/us/>

USA:

HIROSE ELECTRIC (U.S.A.), INC. DETROIT OFFICE (AUTOMOTIVE)
 37677 Professional Center Drive, Suite #100C
 Livonia, MI 48154
 Phone : +1-734-542-9963
 Fax : +1-734-542-9964
<http://www.hirose.com/us/>

THE NETHERLANDS:

HIROSE ELECTRIC EUROPE B.V.
 Hogehillweg #8 1101 CC Amsterdam Z-0
 Phone : +31-20-6557460
 Fax : +31-20-6557469
<http://www.hirose.com/eu/>

GERMANY:

HIROSE ELECTRIC EUROPE B.V. GERMAN BRANCH
 Herzog-Carl-Strasse 4 D-73760 Ostfildern
 (Scharnhäuser Park)
 Phone : +49-711-4560-02-1
 Fax : +49-711-4560-02-299
<http://www.hirose.com/eu/>

GERMANY:

HIROSE ELECTRIC EUROPE B.V. NUERNBERG OFFICE
 Muggenhofer Str. 136 90429 Nuernberg
 Phone : +49-911 32 68 89 63
 Fax : +49-911 32 68 89 69
<http://www.hirose.com/eu/>

UNITED KINGDOM:

HIROSE ELECTRIC EUROPE BV (UK BRANCH)
 4 Newton Court, Kelvin Drive, Knowlhill,
 Milton Keynes, MK5 8NH
 Phone : +44-1908 202050
 Fax : +44-1908 202058
<http://www.hirose.com/eu/>

CHINA:

HIROSE ELECTRIC (SHANGHAI) CO., LTD.
 1601, Henderson Metropolitan, NO.300, East Nanjing
 Road, Huangpu District, Shanghai, China 200001
 Phone : +86-21-6391-3355
 Fax : +86-21-6391-3335
<http://www.hirose.com/cn/>

CHINA:

HIROSE ELECTRIC (SHANGHAI) CO.,LTD. BEIJING BRANCH
 A1001, Ocean International Center, Building 56# East 4th
 Ring Middle Road, ChaoYang District, Beijing, 100025
 Phone : +86-10-5165-9332
 Fax : +86-10-5908-1381
<http://www.hirose.com/cn/>

CHINA:

HIROSE ELECTRIC TECHNOLOGIES (SHENZHEN) CO., LTD.
 Room 09-13, 19/F, Office Tower Shun Hing Square, Di Wang Commercial Centre,
 5002 Shen Nan Dong Road, Shenzhen City, Guangdong Province, 518008
 Phone : +86-755-8207-0851
 Fax : +86-755-8207-0873
<http://www.hirose.com/cn/>

HONG KONG:

HIROSE ELECTRIC HONGKONG TRADING CO., LTD.
 Room 1001, West Wing, Tsim Sha Tsui Centre, 66
 Mody Road, Tsim Sha Tsui East, Kowloon, Hong Kong
 Phone : +852-2803-5338
 Fax : +852-2591-6560
<http://www.hirose.com/hk/>

TAIWAN:

HIROSE ELECTRIC TAIWAN CO., LTD.
 103 8F, No.87, Zhengzhou Rd., Taipei
 Phone : +886-2-2555-7377
 Fax : +886-2-2555-7350
<http://www.hirose.com/cn/>

KOREA:

HIROSE KOREA CO., LTD.
 1261-10, Jeoungwhang-Dong, Shihung-City,
 Kyunggi-Do 429-450
 Phone : +82-31-496-7000,7124
 Fax : +82-31-496-7100
<http://www.hirose.co.kr/>

SINGAPORE:

HIROSE ELECTRIC SINGAPORE PTE. LTD.
 10 Anson Road #26-1, International Plaza
 079903, Singapore
 Phone : +65-6324-6113
 Fax : +65-6324-6123
<http://www.hirose.com/sg/>

INDIA:

HIROSE ELECTRIC SINGAPORE PTE. LTD. DELHI LIAISON OFFICE
 Office NO.519, Regus-Green Boulevard, Level5, Tower C,
 Sec62, Plot B-9A, Block B, Noida, 201301, Uttar Pradesh, India
 Phone : +91-12-660-8018
 Fax : +91-120-4804949
<http://www.hirose.com/sg/>

INDIA:

HIROSE ELECTRIC SINGAPORE PTE. LTD. BANGALORE LIAISON OFFICE
 Unit No.03, Ground Floor, Explorer Building International Tech
 Park Whitefield Road, Bangalore 560066 Karnataka, India
 Phone : +91-80-4120 1907
 Fax : +91-80-4120 9908
<http://www.hirose.com/sg/>

MALAYSIA:

HIROSE ELECTRIC SINGAPORE PTE. LTD. (REPRESENTATIVE OFFICE)
 1-10-07, Suntech @ Penang Cybercity (1164),Lintang
 Mayang Pasir 3,11950, Bayan Baru, Penang, Malaysia.
 Phone : +604-619-2564
 Fax : +604-619-2574
<http://www.hirose.com/sg/>



HIROSE ELECTRIC CO.,LTD.

2-6-3,Nakagawa Chuoh,Tsuzuki-Ku,Yokohama-Shi 224-8540,JAPAN
 TEL: +81-45-620-3526 Fax: +81-45-591-3726
<http://www.hirose.com>
<http://www.hirose-connectors.com>

X-ON Electronics

Largest Supplier of Electrical and Electronic Components

Click to view similar products for [Board to Board & Mezzanine Connectors](#) category:

Click to view products by [Hirose](#) manufacturer:

Other Similar products are found below :

[589158040000018](#) [FCN-230C068-11](#) [FCN-268F012-G/BD](#) [FCN-268F036-G/BD](#) [FCN-268M012-G/0D](#) [FCN-268M024-G/1D](#) [FCN-723J004/1](#) [MIS-048-01-F-D-DP-K](#) [832-10-034-10-001000](#) [FX4C-80S-1.27DSA](#) [FCN-214Q030-G/0](#) [FCN-234P048-G/0](#) [FCN-235D050-G/C](#) [2-22603-0](#) [AXG720047](#) [5031084030](#) [MIT-114-03-F-D-K](#) [55323-1519](#) [YFT-20-05-H-03-SB-K](#) [503308-3040](#) [026-6203-PDB](#) [027-6203-PDB](#) [069159702701000](#) [10123981-102LF](#) [101A10019X](#) [55650-0588-C](#) [68682-310LF](#) [68684-306](#) [75140-7012](#) [87471-650](#) [YTW-30-07-H-Q-410-140](#) [194261-1](#) [FCN-268F024-G0D](#) [10124054-515LF](#) [68685-603](#) [8-1616154-3](#) [MIS-019-01-F-D](#) [FCN-268M024-G/3D](#) [FCN-268M036-G/BD](#) [20021832-06016C1LF](#) [KX15-20KLDL-E1000E](#) [AXE810124](#) [FCN-214J100-G/0](#) [FCN-230C068-E/S](#) [AXE812124](#) [AXE816124](#) [AXE720127](#) [354184](#) [MIT-019-04-F-D-K](#) [P50-028-DDS-TG](#)