

PO6 SERIES RF CO-AXIAL CONNECTORS

Low-profile ultrasmall coaxial connectors D.C.~2000MHz

Overview

The PO6 (Push-on Lock Connectors Type VI) series consists of low-profile ultrasmall coaxial connectors for printed circuit boards. Its purpose is to provide high-density mounting.

The PO6 series is most suitable for high-density in-unit wiring for microwave bands and high-speed pulse transmission.

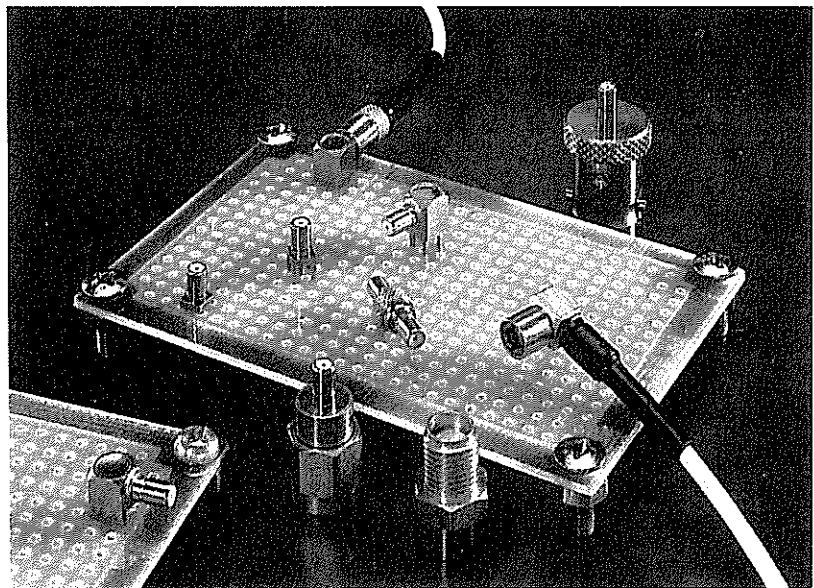

Characteristic Features

- (1) The series is low-profile.
Two models are available; one in which the height above the printed circuit board when coupled is 10.5mm (when PO6-R-RC or PO6-LP-196/U is fitted), and one in which it is 6mm (when PO6-LR-PC or PO6-P-196/U is fitted).
- (2) The series is ultrasmall in size.
The sizes have been reduced to about 80% in comparison with our company's UM type connectors (CR type), which have won an excellent reputation in mobile radio systems.
- (3) There is a high reliability.
Since the coupling parts have a lock mechanism which is unique to our company alone, the series has an unexcelled reliability when exposed to external forces such as vibrations, impacts, twisting, etc.
- (4) The series has a high degree of compatibility. The high-frequency characteristics are excellent. The V.S.W.R. is 1.2 or less from 0 to 2000MHz.
- (5) The standard cables are RG-196/U cables.

Uses

Microwave communication equipment, wired and wireless communication equipment, radio equipment, mobile radio equipment, IC testers, electronic measuring instruments, broadcasting equipment, etc.

Performance characteristics

Items	Standard values
Impedance	50Ω
Insulation resistance	1000MΩ or more at 250V DC
Contact resistance	Center conductor 6.5mΩ or less, outer conductor 4mΩ or less at 1A DC
Withstand voltage	1 minute at 250V AC r.m.s.
Voltage standing wave ratio	1.2 or less at 0 ~ 2000MHz
Coupling force (withstand force)	500g or more

Guide to products

The following are typical products of the P06 series:

HRS No.	Part No.	Applicable cable
CL328-0001-3-40	PO6-P-196/U(40)	RG-196/U

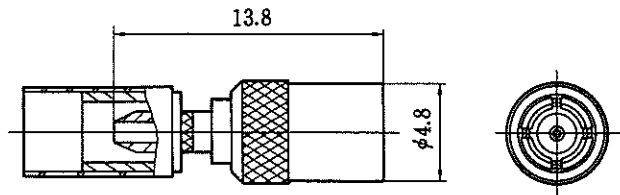
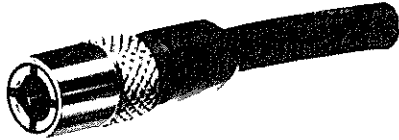

HRS No.	Part No.	Applicable cable
CL328-0002-6-40	PO6-LP-196/U(40)	RG-196/U

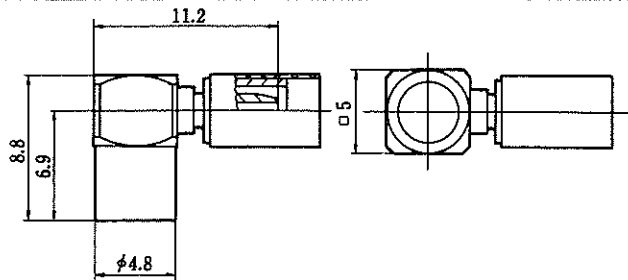
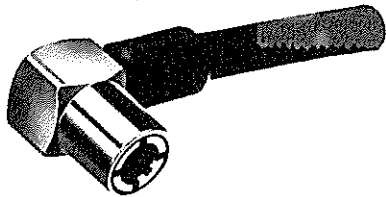

HRS No.	Part No.	A dimensions	B dimensions
CL328-0011-7-40	PO6-R-PC(40)	2.5	2.4
CL328-0013-2-40	PO6-R-PC-1(40)	3.3	3.2

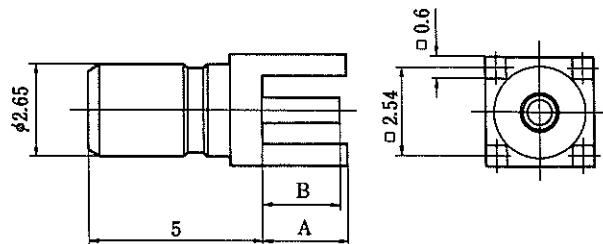
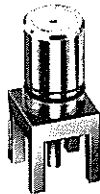

HRS No.	Part No.
CL328-0012-0-40	PO6-LR-PC(40)

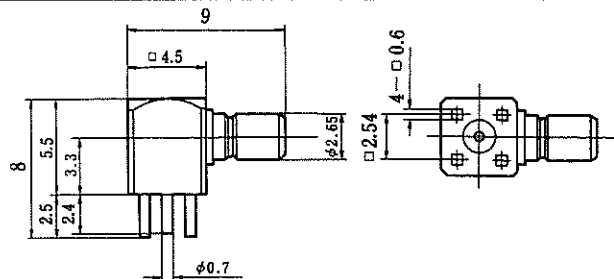
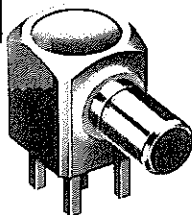

P06 SERIES RF CO-AXIAL CONNECTORS

HRS No.	Part No.
CL328-0021-0-40	P06-A-JJ(40)

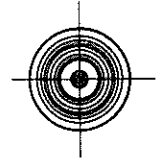
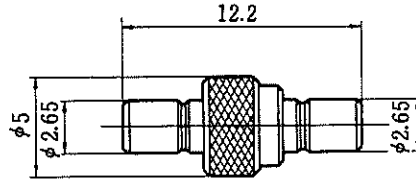
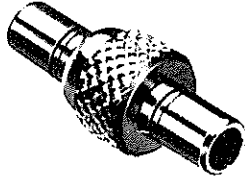

Converter adapter

For converter adapters for connecting the P06 series to other series, see the CL311BWA series.

Drawing of holes drilled in printed circuit boards.

When P06-R-PC, P06-RC-PC-1 and P06-LR-PC are to be used, machine the printed circuit boards according to the drawing.

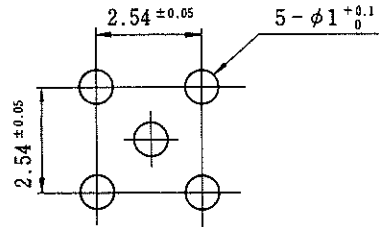

P06 SERIES RF CO-AXIAL CONNECTORS

Method for connecting cable wiring.

Method for connecting wiring of P06-P-196/U

Process 1. Insertion of heat-shrinkable tubing and solderless sleeve.

Fig. 1

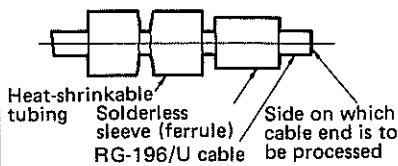

- 1) Insert the heat-shrinkable tubing and the ferrule (sleeve) onto the cable. Insert first the heat-shrinkable tubing and then the ferrule (sleeve) from the side on which the cable end is to be processed. (The sequence is shown in Fig. 1.)

Process 2. Processing the cable end.

Fig. 2

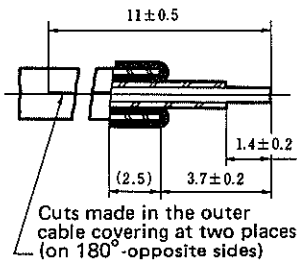

- 1) The processing dimensions for the cable end are shown in Fig. 2. The cable end is processed in the following sequence:
 1. Remove the outer cable covering.
 2. Make cuts in the outer cable covering at two places.
 3. Fold back the outer conductor.
 4. Remove the cable insulation.

Process 3. Soldering of the male contact and the center conductor of the cable.

Fig. 3

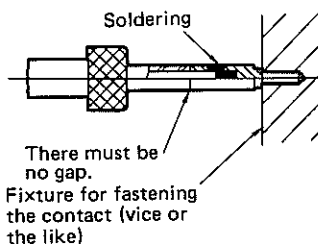

- 1) Solder the male contact to the center conductor of the cable as shown in Fig. 3.
 1. Perform preliminary soldering at the soldering hole of the male contact with $\phi 0.5$ string solder.
 2. There must be no gaps between the surface of the male contact and the surface of the cable insulation.
 3. If the solder has run down onto the outer part of the male contact, finish that part uniformly with a knife or the like.
 4. To confirm that the soldering has been performed accurately, pull with a force of about 500g.

Process 4. Crimp connection of outer conductor of cable.

Fig. 4

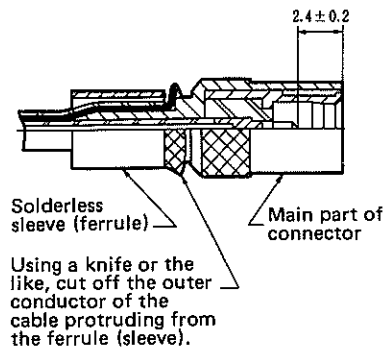

- 1) Insert the cable into the main part of the connector. Insertion of the cable is finished when it strikes. To confirm that it has been completely inserted, use vernier calipers or the like to measure the depth from the end of the main part of the connector to the end of the tip of the male contact, and make sure that it is 2.4 ± 0.2 .
- 2) Use HT303/P06-T-1 to make a crimp connection of the ferrule (sleeve) which was inserted in Process 1.
- 3) The shape of the crimping part of the crimping sleeve should be as shown in Fig. 5. Match part A with the cut in the cable sheath.

Fig. 5

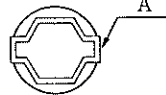

Process 5. Shrinking of heat-shrinkable tubing.

Fig. 6

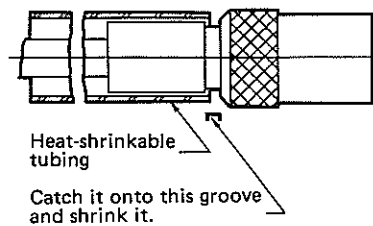

- 1) After the heat-shrinkable tubing has been inserted into the cable in Process 1, shrink it with a heat gun or the like.

P06 SERIES RF CO-AXIAL CONNECTORS

Method for connecting wiring of P06-LP-196/U

Process 1. Insertion of heat-shrinkable tubing and ferrule.

Same as process 1 of P06-P-196/U

Process 2. Processing the cable end.

Fig. 1

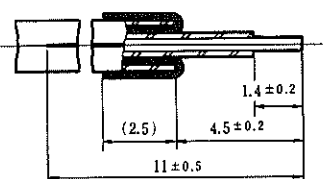

- 1) The processing dimensions for the cable end are shown in Fig. 1. The sequence in processing the end is the same as in Process 2 of P06-P-196/U.

Process 3. Crimp connection of outer conductor of cable.

Fig. 2

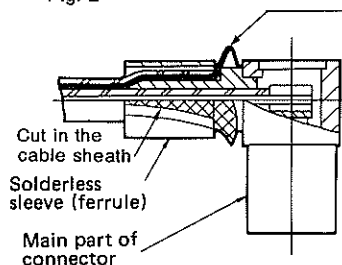

Using a knife or the like, cut off the outer conductor of the cable protruding from the ferrule (sleeve).

- 1) Insert the cable into the connector. Insertion of the cable is finished when the surface of the cable insulator strikes against the surface of the male contact of the connector.

Fig. 3

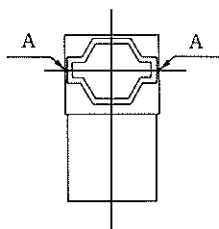

- 2) Use HT303/P06-T-1 to make crimp connections of the ferrule (sleeve) which was inserted in Process 1.
- 3) The crimping direction of the ferrule (sleeve) is to be as shown in Fig. 3.

Process 4. Crimp connection of center conductor of cable.

Fig. 4

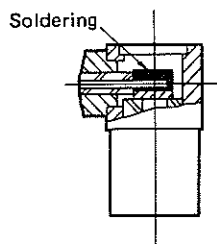

- 1) Solder the center conductor of the cable to the male contact of the connector.
1. The tip of the soldering iron is about $\phi 0.8$, and $\phi 0.5$ string solder is used as the solder.
2. In soldering, be careful not to allow solder to be deposited onto the outer surface of the male contact of the connector.
3. Soils on the inside of the connector produced as a result of soldering should be washed off with thinner or the like and cleaned off with compressed air in order to prevent the occurrence of faulty insulation or inadequate withstand voltage.

Process 5. Pressure-fitting of the cover and shrinking of the heat-shrinkable tubing

Fig. 5

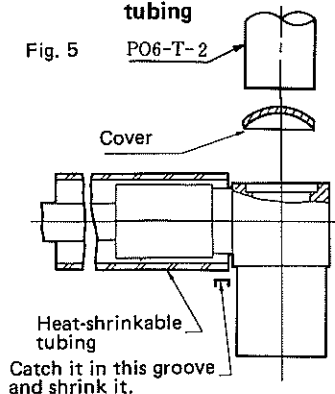

- 1) Using a drill press or the like, pressure-fit the cover into the connector with a pressure-fitting bar of $\phi 3.3 \pm 0.05$.
- 2) After the heat-shrinkable tubing has been inserted into the cable in Process 1, shrink it with a heat gun or the like.

X-ON Electronics

Largest Supplier of Electrical and Electronic Components

Click to view similar products for [RF Connectors / Coaxial Connectors](#) category:

Click to view products by [Hirose](#) manufacturer:

Other Similar products are found below :

[8915-1511-000](#) [89674-0827](#) [6001-7071-019](#) [6002-7051-003](#) [6002-7551-202](#) [6059674-1](#) [619550-1](#) [630059-000](#) [M39030/3-01N](#) [6500-7071-046](#) [6769](#) [CX050L2AQ](#) [7002-1542-011](#) [7004-1512-000](#) [7009-1511-004](#) [7010-1511-000](#) [7029-1511-060](#) [7101-1541-010](#) [7101-1571-002](#) [7105-1521-002](#) [7145-1521-002](#) [7203-1571-003](#) [7209-1511-011](#) [7210-1511-015](#) [7210-1511-019](#) [73137-5015](#) [73216-2241](#) [7325-1512-000](#) [73404-2300](#) [7405-1521-005](#) [7405-1521-802](#) [7406-1521-005](#) [8527](#) [8547](#) [FS11V](#) [8808-1511-001](#) [9049-9513-000](#) [9074-9513-000](#) [9101-9573-002](#) [910A205F](#) [9130-9573-002](#) [PL11SC-026](#) [PL375-33](#) [PL40-5](#) [PL71-9](#) [PL74C-221](#) [PL75MC-217](#) [PL803-7](#) [980-8666-005](#) [1200690078](#)