

# QR/P4 SERIES

## Small Rectangular Multi-electrode Solderless Connectors for Racks and Panels

### General

QR/P4 Series is a series of small connectors for rack and panel application. This is a smaller-size version of the QR/P and QR/P1 Series, whose rectangular multi-electrode plug in connectors for racks and panels have been well received in the market.

Six models with different numbers of contacts are available: 8, 12, 16, 24, 32 and 40. Wires are connected to the connectors without solder for easier connection and higher reliability.

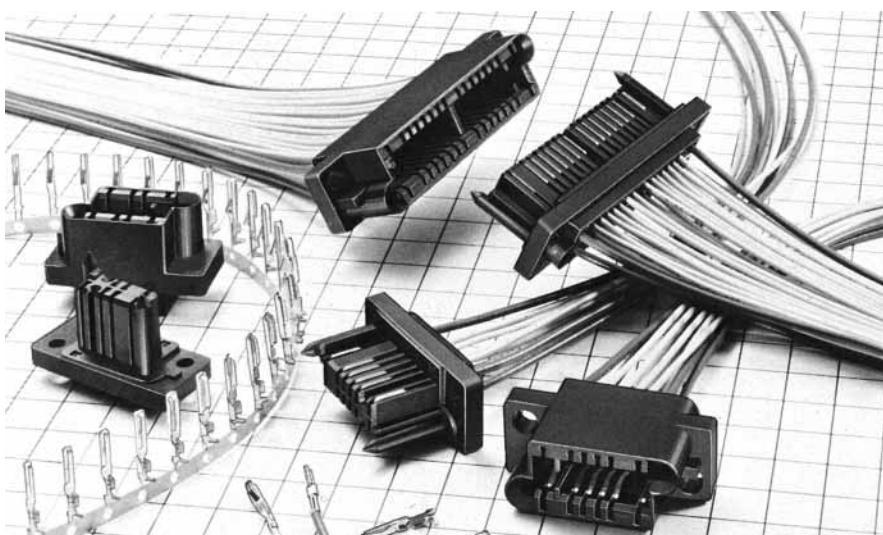

### Features

- (1) The pins can be smoothly inserted into the receptacle, and give stable contact pressure because of their point contact with the receptacle blades. Furthermore, they have a larger allowance for the variation of connection length - a characteristic of plug-in connections.
- (2) The connector size has been made smaller by separating the terminals for signals from those for voltage supply.
- (3) The pitch of the signal terminals inside the housing is 2.54mm. Two pairs of diametrically opposed electrodes (four electrodes in total) on the two sides are arranged with a pitch of 5.08mm so that they can withstand high voltage, and can be used for power supply. In addition, a nonflammable material (UL94V-0) is used as the insulating housing of the connectors.
- (4) Guide pins and the housing body are molded as one piece to achieve a smaller connector size.
- (5) Since the connectors are mounted on racks or panels with stepped screws, connection and disconnection can be done easily.
- (6) The contact for female terminals in the housing is deeper than the fitting surface of the housing which conforms to the finger test (UL Standard 1950).
- (7) The connectors of this series have passed UL, CSA and TÜV standard.

### Application

PPC, Transmission and reception equipment, Data Communication, Vending Machine, Measuring Instruments, Automatic Equipment, Switchboards, etc.

## Specification

Item	Specifications	
Contact Resistance	Power	Max. 15mΩ at DC1A
	Signal	Max. 15mΩ at DC1A
Insulation Resistance	Min. 5000MΩ at DC500V	
Withstand Voltage (for 1 minute)	Power	AC 2000V
	Signal	AC 500V
Rated Current	Power	3A
	Signal	1A
Rated Voltage	Power	AC 300V
	Signal	AC 250V

Item	Material	Finish
Insulator	PBT resin *:UL94V-0	Black
Contact	Phosphor Bronze	Selective Gold plating over Nickel

Ratings authorized by QR/P4 safety standards			
Safety standard		UL CSA. TÜV	
Operating temperature		- 10 ~ + 60℃	
Rated Voltage	Power supply	AC 30V	AC380V, DC450V
	Signal unit	AC 250V	AC120V, DC150V
Rated current	AWG#20	3A	2.5A
	AWG#22		1A
	AWG#24	2A	
	AWG#26	1A	
	AWG#28		

## Ordering Information

▲ Connector Unit      QR / P4 — 12 P — C — (01)  
    (1)                    (2)(3)                    (4)                    (10)

▲ Contact                    QR / P1 — PC 2 A — 1 1 1  
    (1)                    (5) (6)                    (7)(8)(9)

- |  |  |
|--|--|
| (1) Series name                            | (6) Size of Barrel   |
| (2) No.of contacts (8, 12, 16, 24, 32, 40) | 2A: Thin Wire (UL1007 Type)  |
| (3) Type of Housing                        | 2B: Thin Wire (UL1007 Type) . . . For 4 contact holes at both ends |
| P: Plug Housing                            | (7) Contact Type   |
| S: Socket Housing                          | 1: Loose Contact   |
| (4) Type of termination                    | 2: Chain Contact   |
| C: Crimping                                | (8) Applicable wire  |
| (5) Type of Contact                        | 1: Thin Wire AWG #24 - #28   |
| PC: Pin Contact                            | 2: Thick Wire AWG #20 - #24  |
| SC: Socket Contact                         | (9) Finish   |
|  | 1: Selective Gold plated over Nickel                               |
|  | (10) UL, CSA, TÜV  |
|  | Approved Spec  |

## Housing

### Male Housing

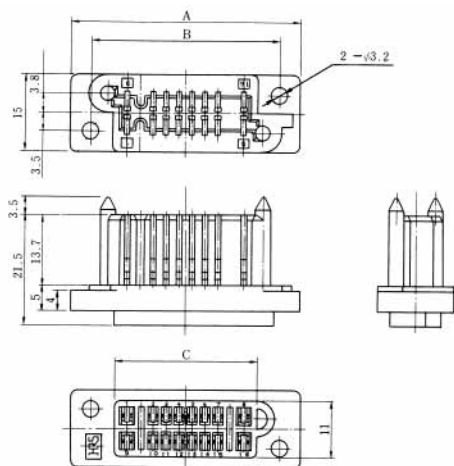

Unit: mm

HRS No.	No. of Pin	Part No.	A	B	C	RoHS
CL221-0159-5-01	8	QR/P4-8P-C(01)	34.68	26.68	17.68	○
CL221-0139-8-01	12	QR/P4-12P-C(01)	39.8	31.8	22.8	
CL221-0155-4-01	16	QR/P4-16P-C(01)	44.84	36.84	27.84	
CL221-0141-0-01	24	QR/P4-24P-C(01)	55	47	38	
CL221-0153-9-01	32	QR/P4-32P-C(01)	67.7	59.7	50.7	
CL221-0211-3-01	40	QR/P4-40P-C(01)	77.86	69.86	60.86	

### Female Housing

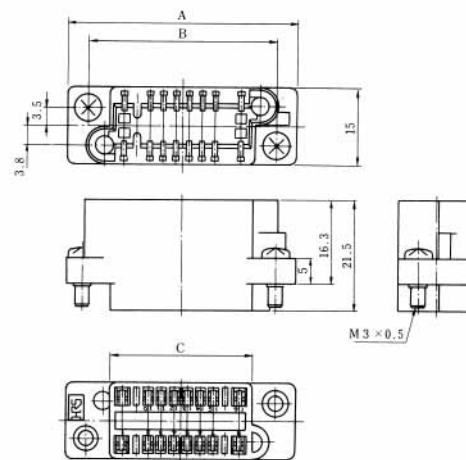

Unit: mm

HRS No.	No. of Pin	Part No.	A	B	C	RoHS
CL221-0160-4-01	8	QR/P4-8S-C(01)	34.68	26.68	17.68	○
CL221-0140-7-01	12	QR/P4-12S-C(01)	39.8	31.8	22.8	
CL221-0156-7-01	16	QR/P4-16S-C(01)	44.84	36.84	27.84	
CL221-0142-2-01	24	QR/P4-24S-C(01)	55	47	38	
CL221-0154-1-01	32	QR/P4-32S-C(01)	67.7	59.7	50.7	
CL221-0212-6-01	40	QR/P4-40S-C(01)	77.86	69.86	60.86	

Note: Determine the combinations with the panel so that the mating clearance between the P side and S side is 1.5mm or less.

## Contact

### Power Male Contact

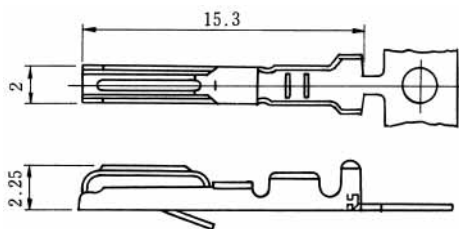

### Power Female Contact

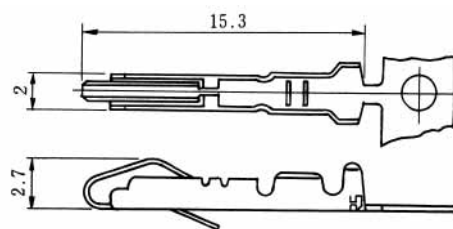

Selective gold plated with nickel under plating

Applicable Wire	HRS No.	Part No.	Type	Packing	RoHS
AWG#20~24	CL221-0115-0-12	QR/P1-PC2B-121(12)	Loose contact	100pin	○
	CL221-0119-0-12	QR/P1-PC2B-221(12)	Chain contact	5,000pin	

Selective gold plated with nickel under plating

Applicable Wire	HRS No.	Part No.	Type	Packing	RoHS
AWG#20~24	CL221-0117-2-12	QR/P1-SC2B-121(12)	Loose contact	100pin	○
	CL221-0121-2-12	QR/P1-SC2B-221(12)	Chain contact	5,000pin	

## Contact

### Signal Male Contact

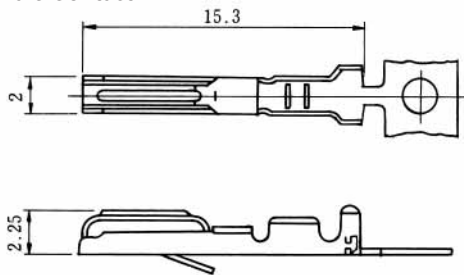

Partly gold plated over nickel plating

Applicable Wire	HRS No.	Part No.	Type	Packing	RoHS
AWG#20~24	CL221-0103-0-12	QR/P1-PC2A-111 (12)	Loose contact	100pin	○
	CL221-0107-1-12	QR/P1-PC2A-211 (12)	Chain contact	5,000pin	

### Signal Female Contact

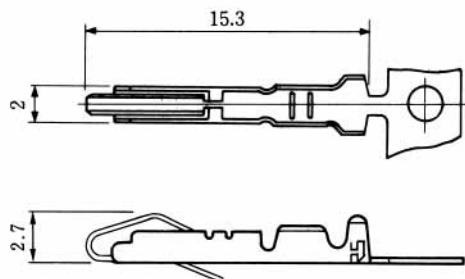

Partly gold plated over nickel plating

Applicable Wire	HRS No.	Part No.	Type	Packing	RoHS
AWG#24~28	CL221-0105-6-12	QR/P1-SC2A-111 (12)	Loose contact	100pin	○
	CL221-0109-7-12	QR/P1-SC2A-211 (12)	Chain contact	5,000pin	

## Panel Cutout

### QR/P4-※P-C

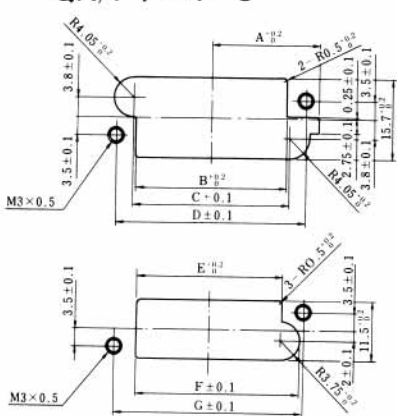

		No. of pin	8pin	12pin	16pin	24pin	32pin	40pin
Rear Mounting	A	15.87	18.45	20.97	26.05	32.4	37.48	
	B	19.18	24.3	29.34	39.5	52.2	62.36	
	C	20.18	25.3	30.34	40.5	53.2	63.36	
	D	26.68	31.8	36.84	47	59.7	69.86	
Front Mounting	E	18.18	23.3	28.34	38.5	51.2	61.36	
	F	21.68	26.8	31.84	42	54.7	64.86	
	G	26.68	31.8	36.84	47	59.7	69.86	

### QR/P4-※S-C

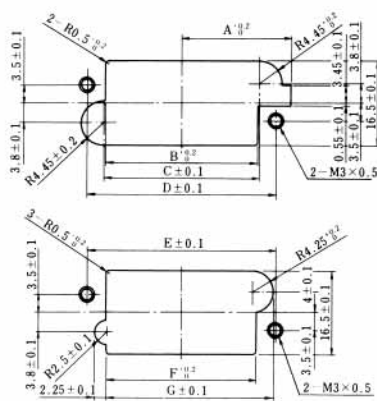

		No. of pin	8pin	12pin	16pin	24pin	32pin	40pin
Rear Mounting	A	16.87	18.95	21.49	26.57	32.9	37.98	
	B	19.68	24.8	29.84	40	52.7	62.86	
	C	20.18	25.3	30.34	40.5	53.2	63.36	
	D	26.68	31.8	36.84	47	59.7	69.86	
Front Mounting	E	26.68	31.8	38.84	47	59.7	69.86	
	F	19.18	24.3	29.34	39.5	52.2	62.36	
	G	22.68	27.8	32.84	43	55.7	65.68	

## Tooling

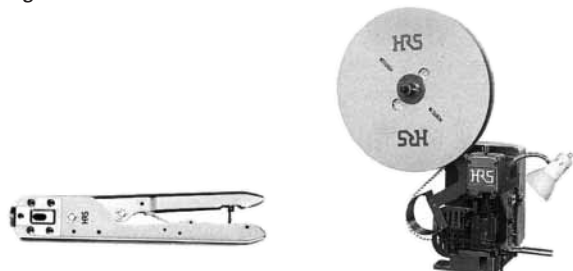

Hand Crimp Tool

Auto Crimp Machine  
CM-105  
CL901-0005-4

Kind	HRS No.	Part No.	Applicator Contact
Hand Crimp Tool	CL250-0021-3	TC-QR/P1-PC2B	QR/P1-PC2B-121
	CL250-0016-3	TC-QR/P1-PC2A	QR/P1-PC2A-111
	CL250-0023-9	TC-QR/P1-SC2B	QR/P1-SC2B-121
	CL250-0018-9	TC-QR/P1-SC2A	QR/P1-SC2A-111
Auto Crimp Machine Applicator	CL901-2530-5	AP105-QR/P1-2B-2	QR/P1-PC2B-221
			QR/P1-SC2B-221
	CL901-2528-3	AP105-QR/P1-2A-1	QR/P1-PC2A-211
Extraction Tool	CL250-0029-5	TC-QR/P4-21	QR/P1-SC2A-211
			QR/P1-SC2, PC2

## Contacts for thick wire Contact Configuration

Male Housing (Viewed from Wiring Side)

■: indicates a contact hole for thick wire

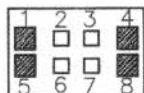

QR/P4-8P-C (01)



QR/P4-12P-C (01)

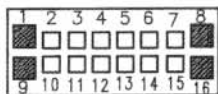

QR/P4-16P-C (01)

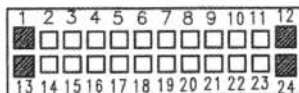

QR/P4-24P-C (01)

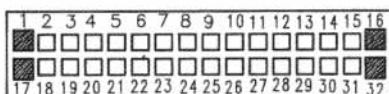

QR/P4-32P-C (01)

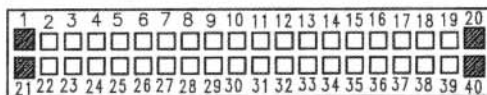

QR/P4-40P-C (01)

## X-ON Electronics

Largest Supplier of Electrical and Electronic Components

*Click to view similar products for [Rack & Panel Connectors](#) category:*

*Click to view products by [Hirose](#) manufacturer:*

Other Similar products are found below :

[00171410002](#) [00171420202](#) [00171440002](#) [02-014-013-5200-000](#) [613467-000](#) [CTJ112E01E-513](#) [CTJ116E03A-513](#) [CTJ720E01B-513 L/C](#)  
[66020-2](#) [CW8958-000](#) [699886-000](#) [D250-50632](#) [70.400.3240.0](#) [70.955.2453.3](#) [733753-000](#) [F22831-000](#) [780-522-DPX34RG8-02](#) [8660-501](#)  
[87.060.0053.0](#) [900709N001](#) [928358-1](#) [D-659-0061](#) [DMC-MD 24 C-T](#) [1-445717-6](#) [1484469-2](#) [1604997-2](#) [MTC100-BF1-P31CS015](#)  
[MTC100-KT2-0083](#) [MTC100-KT2-0123-003](#) [MTC100-YA1-005](#) [MTCPQKT1R2PGCA](#) [MTCR-103-04S](#) [MTCX1X-100-100CS025](#)  
[1738331-1](#) [1757667-1](#) [1811481-1](#) [1883433-1](#) [201046-7](#) [202648-4](#) [213364-1](#) [226503-000](#) [937028-164](#) [1663130-2](#) [172305-4](#) [F36711-000](#)  
[202355-2](#) [202356-2](#) [G20S-AB](#) [CHA-0017-003](#) [CHA-0296](#)