

Sep.1.2021 Copyright 2021 HIROSE ELECTRIC CO., LTD. All Rights Reserved.
In case of consideration for using Automotive equipment / device which demand high reliability, kindly contact our sales window correspondents.

CONTACT MOUNTING

RECOMMENDED PC BOARD PATTERN
(MOUNTING SIDE) t=1.6

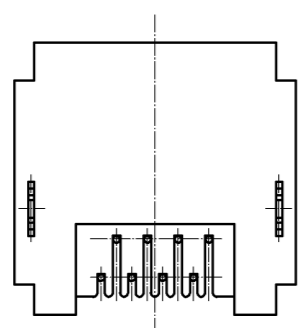
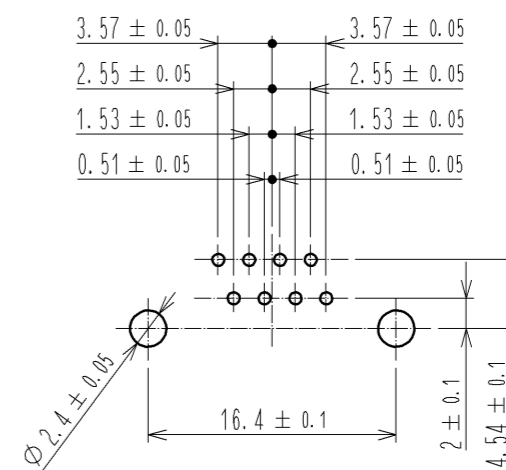
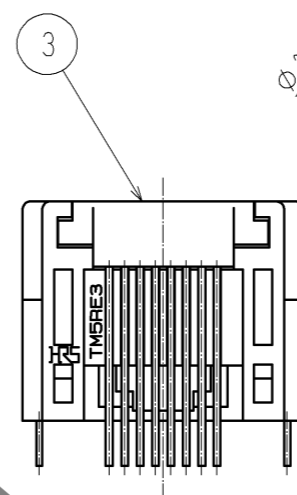
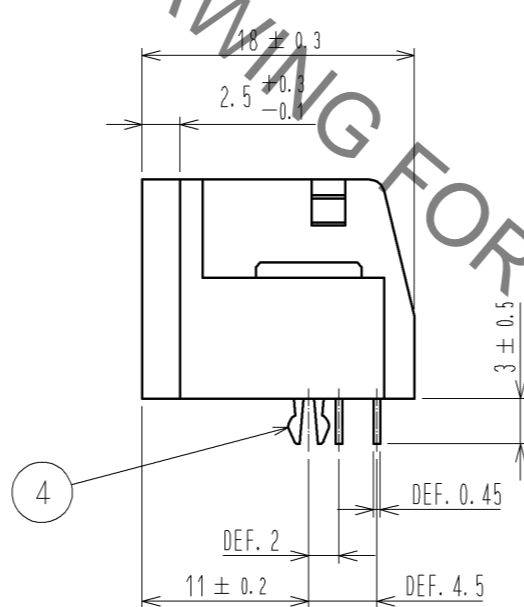
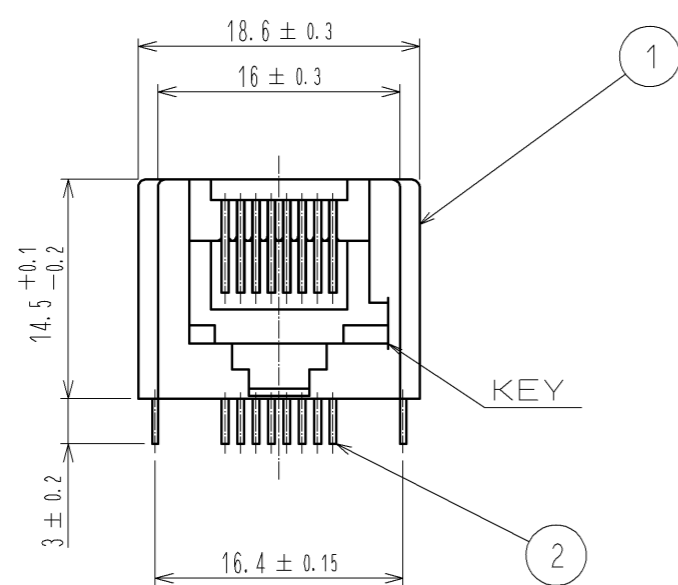
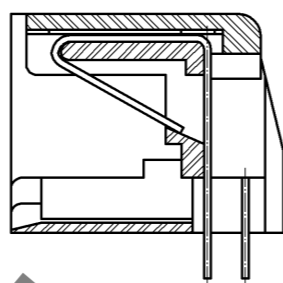
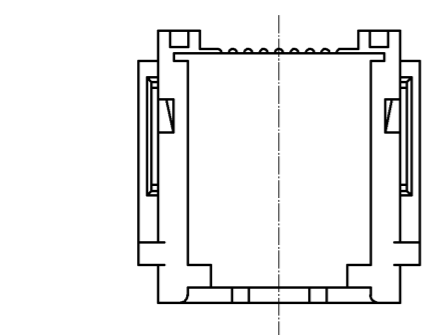

HRS DRAWING FOR REFERENCE

2	PHOSPHOR BRONZE	CONTACT: Au 1.27 μm min LEAD: Au 0.03 μm min UNDER: Ni 1.27 μm min	4	PHOSPHOR BRONZE	OVER: Su(REFLOW Fin) 1μm min			
1	PBT	(DARK GREY)UL94V-0	3	PBT	(DARK GREY)UL94V-0			
NO.	MATERIAL	FINISH . REMARKS	NO.	MATERIAL	FINISH . REMARKS			
UNITS mm		SCALE 2 : 1	COUNT △	DESCRIPTION OF REVISIONS		DESIGNED	CHECKED	DATE
HRS HIROSE ELECTRIC CO., LTD.		APPROVED : YH. ENAMI	08.04.28	DRAWING NO.		EDC3-027886-02		
		CHECED : HK. TANAKA	08.04.28	PART NO.		TM5RE3-88(20)		
		DESIGNED : MT. ITANO	08.04.28	CODE NO.		CL222-1702-7-20		
		DRAWN : MT. ITANO	08.04.28			△ 1/1		

X-ON Electronics

Largest Supplier of Electrical and Electronic Components

Click to view similar products for [Modular Connectors](#) / [Ethernet Connectors](#) category:

Click to view products by [Hirose](#) manufacturer:

Other Similar products are found below :

[8949-H88/06BLKA/SN](#) [74441-0010/BKN](#) [MP1010RX-1000](#) [MP44RX-1000](#) [PHJ-4P4C-1-V-4](#) [PHP-6P6C-5](#) [GAX-3-66](#) [GAX-8-62](#) [GDCX-PA-66-50](#) [GDCX-PN-64](#) [GDCX-PN-66](#) [GDCX-PN-66-50](#) [GDLX-A-66](#) [GDLX-N-66](#) [GDLX-S-66](#) [GDLX-S-88K](#) [GDTX-S-88-50](#) [GDX-PA-1010](#) [GLX-N-1010M-BLK](#) [GLX-S-88M-BLK](#) [GMX-N-1010](#) [GMX-S-1010](#) [GMX-S-66](#) [GMX-SMT4-N-88](#) [GPX-2-64](#) [GSGX-N-2-88](#) [GSGX-N-4-88](#) [GSX-NS2-88-3.05-50](#) [PT-108A-8C-UL](#) [PT-J951-8C](#) [PTS-J531-8CS-50UL](#) [1-1775629-2](#) [A-2014-0-4](#) [GWLX-S-88-GR](#) [GWLX-S9-88-YG](#) [DC-1021-8-WH-6](#) [1300530003](#) [1324640-4](#) [RJ11FTVC2G](#) [RJ11FTVC2N](#) [RJFTVX2SA1G](#) [132764-001](#) [1413235](#) [MP88X-1000](#) [MPS88RX-5000](#) [MRJR-5481-0F2](#) [E5288-S000K3-L](#) [E5908-15A242-L](#) [155302-001](#) [AX100653](#)