

# Ultra Small Surface Mount Coaxial Connectors 1.4mm or 1.65mm Mated Height

## W.FL Series

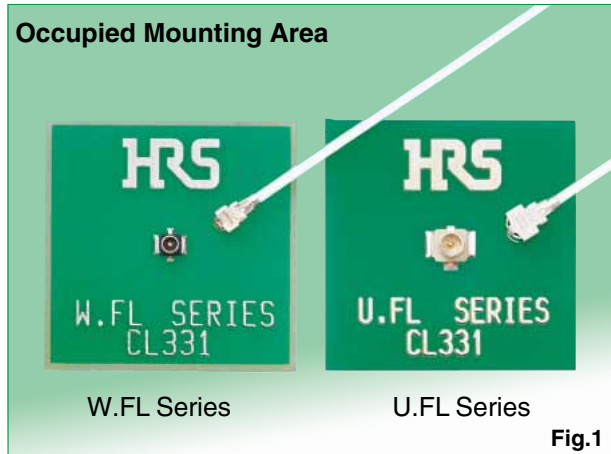
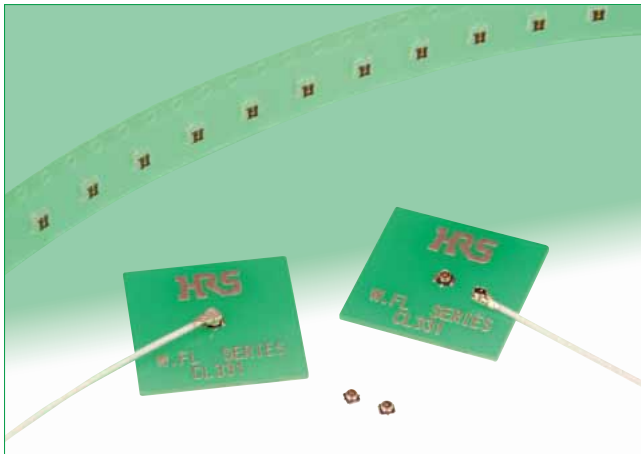

Fig.1

### ■ Features

#### 1. Nominal mated height of 1.4mm or 1.65mm (Max. 1.55 or 1.85mm)(Fig.2)

#### 2. Small board footprint

The W.FL Series is about 55% smaller than our U.FL Series connector and only uses 3.4mm<sup>2</sup> of PCB space. The PCB layout for the W.FL Series is the same as for W.FL2 and X.FL Series.

Note: This product is not compatible with W.FL2 Series and X.FL Series. (Fig.1)

#### 3. Extremely light weight

Receptacle: 5.6 mg

Right-angle plug: 18.6 mg(040), 28.2mg(062)

#### 4. Frequency range up to 6 GHz

DC to 3 GHz : V.S.W.R. of 1.3 max.

3 GHz to 6 GHz: V.S.W.R. of 1.4 max.

#### 5. Automatic board placement

Packaged on tape-and-reel the receptacles can be placed with vacuum nozzles of the automatic placement equipment.

#### 6. Plugs are terminated with ultra-fine coaxial (fluorinated resin insulated) cable

The use of ultra-fine coaxial (fluorinated resin insulated) cables on these connectors offer the ability to complete connections in small, confined spaces with a smooth, easy operation.

#### 7. Simple connector mating / unmating

Use of the available mating/un-mating tools assures correct connection/disconnection of the plug and receptacle.

#### 8. Halogen-free\*(Receptacle, Plug(HF type))

\*As defined by IEC61249-2-21

Br-900ppm maximum, Cl-900 ppm maximum, Cl+Br combined-1,500 ppm maximum

### Mated height comparison

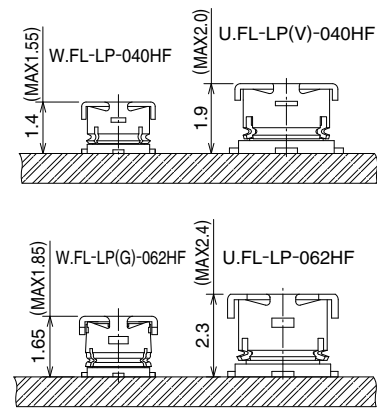

Fig.2

### W. FL Plug and Receptacle

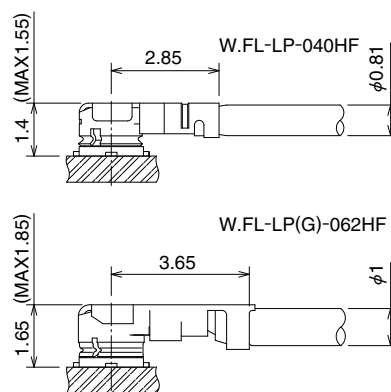
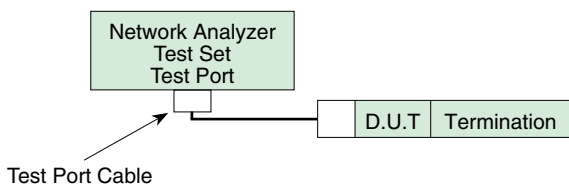

Fig.3

## Specifications

Rating	Nominal characteristic impedance	50Ω	Operating temperature range	-40°C to +90°C (90% RH max.)
	Frequency range	DC to 6 GHz	Storage temperature range	-30°C to +70°C (90% RH max.)
Item	Specification		Conditions	
1. Contact resistance	Center contact : 20mΩ max. Outer contact : 10mΩ max.		10mA max.	
2. Insulation resistance	500MΩ min.		100V DC	
3. Withstanding voltage	No flashover or insulation breakdown		200V AC / 1 minute	
4. V.S.W.R.*	1.3 Max. 1.4 Max.		Up to 3 GHz 3 to 6 GHz	

\*V.S.W.R. Measurement System  
Measured as shown on the block diagram below.



Note1 : Measurement way of a W.FL Cable assembly (plug)  
W.FL Cable assembly (plug) is measured with SMA conversion adapters mated with W.FL plugs at both ends of a 100cm coaxial cable harness

Note2 : Measurement way of a W.FL receptacle  
W.FL receptacle, which is mounted on a 50Ω glass epoxy board, is measured with a SMA conversion adapter.

## Materials / Finish

### ●Plug – right angle

Part	Material	Finish / Remarks
Shell	Phosphor bronze	Silver plated
Female center contact	Phosphor bronze	Gold plated
Insulator	PBT	Color : Gray, UL94V HB(040HF, 062HF)

### ●Receptacle

Part	Material	Finish / Remarks
Shell	Phosphor bronze	Silver plated
Insulator	LCP	Color : Black, UL94V-0
Male center contact	Brass	Gold plated

## Cable Assembly(Plug)

W.FL-LP-040HF(06) (Applicable cable : outer diameter 0.81)

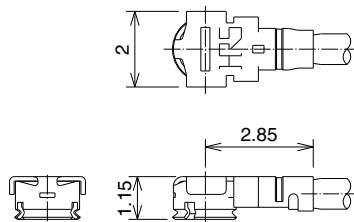

W.FL-LP-062HF(06) (Applicable cable : outer diameter 0.95)

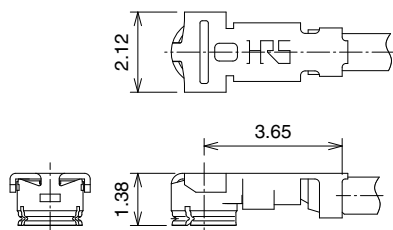

[Plugs can be ordered only as terminated cable assemblies.]

## ◆How to Specify Cable Assembly

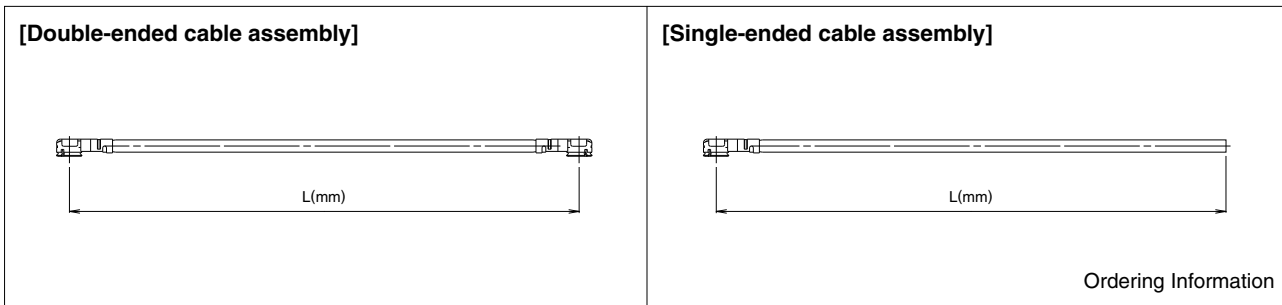

### ●Ordering Information

Used plug : W.FL-LP-040HF(06) (Dia. 0.81)

#### Double-Ended

**W.FL - 2LP HF6 - 04N [ ] TV - A - L**

①      ②      ③      ④      ⑤      ⑥      ⑦

#### Single-Ended

**W.FL - LP HF6 - 04N [ ] TV - A - L**

①      ②      ③      ④      ⑤      ⑥      ⑦

① Series name	W.FL
② Assembly type	LP : Single ended 2LP : Double ended
③ Environmental compliant	HF6 : Halogen-free
④ Cable type	04N : 0.81mm dia. ultra-fine coaxial cable
⑤ Cable Color	1 : White 2 : Black
⑥ Cable outer conductor	TV : Tin plated braided wire
⑦ Total length(mm)	Length(L)

Used plug:W.FL-LP(G)-062HF(06) (Dia. 0.95)

#### Double-Ended

**W.FL - 2LPG HF6 - 062N [ ] D - A - L**

①      ②      ③      ④      ⑤      ⑥      ⑦

#### Single-Ended

**W.FL - LPG HF6 - 062N [ ] D - A - L**

①      ②      ③      ④      ⑤      ⑥      ⑦

① Series name	W.FL
② Assembly type	LPG : Single ended 2LPG : Double ended
③ Environmental compliant	HF6 : Halogen-free
④ Cable type	062N : 0.95mm dia. ultra-fine coaxial cable
⑤ Cable Color	1 : Gray 2 : Black 3 : White
⑥ Cable outer conductor	D : Copper tape + Outer tin plated braided wire
⑦ Total length(mm)	Length(L)

### ●Standard tolerances for (L)

(L)mm	Standard tolerance(mm)
*L=35 to 200	±4
L=200 to 500	±8
L=500 to 1000	±12
L=Longer than 1000	±1.5% of (L)

Note : Minimum available length(L) is 35mm.

### Receptacle

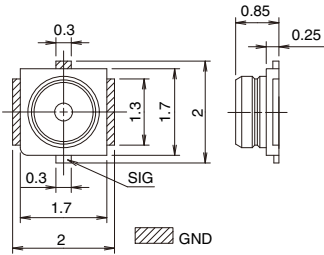
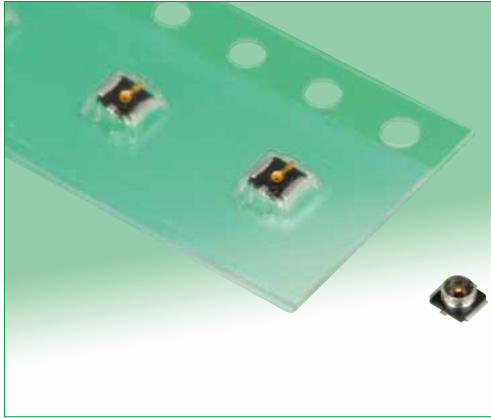

### Recommended PCB mounting pattern

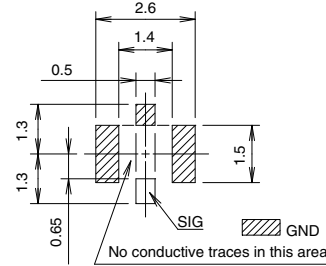

Note : The land pattern is the same as that of the X.FL, W.FL2 series connectors.

All dimensions : mm

Part No.	HRS No.	Packaging
W.FL-R-SMT-1(60)	331-0482-6 60	Reel (5,000 pcs/reel)
W.FL-R-SMT-1(80)	331-0482-6 80	Reel (10,000 pcs/reel)

### Embossed Carrier Tape Dimensions(IEC 60286-3 compliant)

#### Embossed Carrier Tape Dimensions

(W.FL-R-SMT-1(60) 8mm pitch)

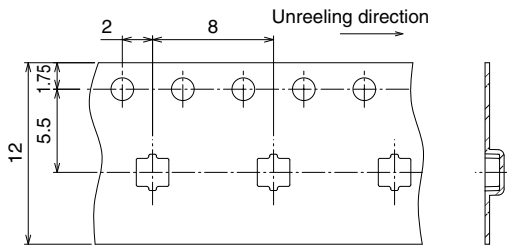

(W.FL-R-SMT-1(80) 4mm pitch)

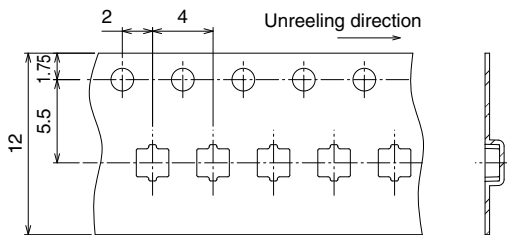

#### Reel Dimensions

Material : PS(Black)

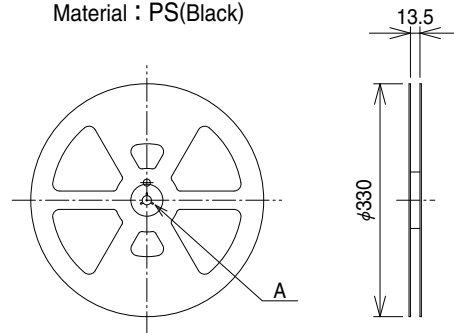

A(SCALE FREE)

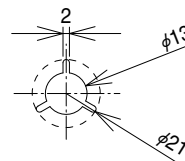

## ■ Conversion Adapters

### ● SMA Conversion Adapter (W.FL side jack – SMA side plug)

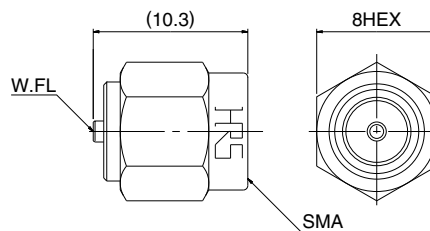

Note : Used for performance measurements only.  
The W.FL mating side has lower retention force than the regular product when mated to the corresponding part.

Part No.	HRS No.	Packaging
HRMP-W.FLJ(40)	311-0367-3 40	1

### ● SMA Conversion Adapter (W.FL side plug – SMA side jack)

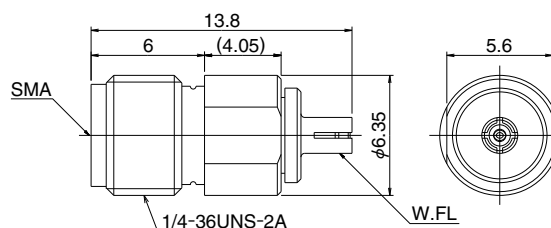

Note : Used for performance measurements only.  
The W.FL mating side has lower retention force than the regular product when mated to the corresponding part.

Part No.	HRS No.	Packaging
HRMJ-W.FLP(40)	311-0368-6 40	1

### ● SMA Conversion Adapter

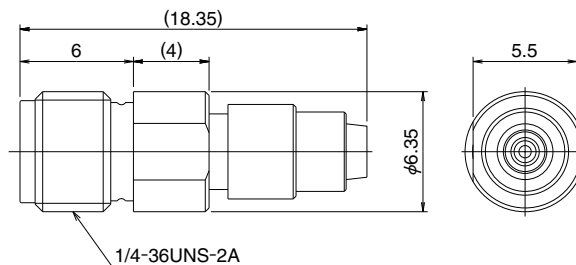

Note : When mating with corresponding part (W.FL-R-SMT-1) it must be pressed down and held to make complete connection.

Part No.	HRS No.	Packaging
HRMJ-W.FLP-ST1(40)	311-0386-8 40	1

## ■Receptacle Inspection Adapter

Used for inspecting the performance parameters of the cable assembly.

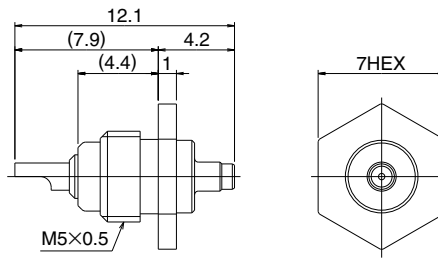
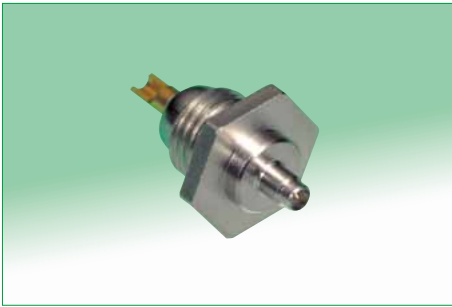

Part No.	HRS No.	Packaging
W.FL-R-1	331-0483-9	1

## ◆Plug-Mating Tool

This tool is used for mating a plug.

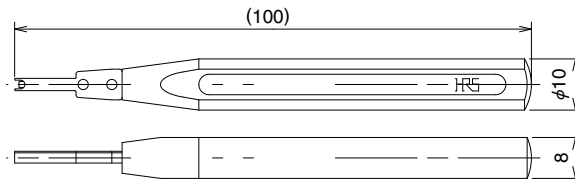

Part No.	HRS No.	Packaging
W.FL-LP-IN	331-0323-2	1

## ◆Plug-Extraction Tool

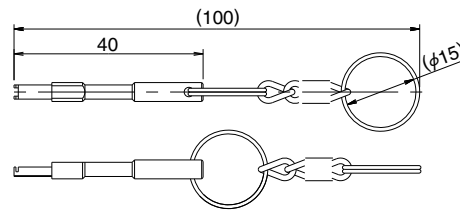
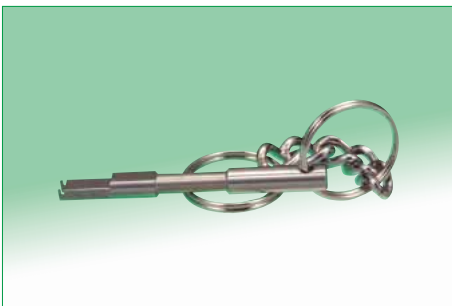

Part No.	HRS No.	Packaging
W.FL-LP-N	331-0492-0	1

**◆ Precautions**

**1. Plug**

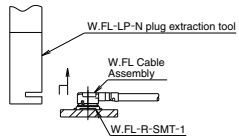
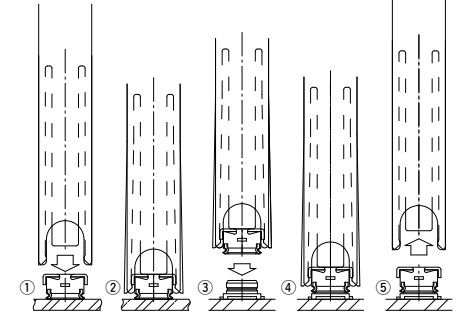
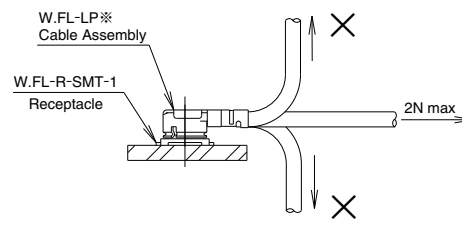
<p>(1) Mating / unmating</p>	<p>• <b>Unmating</b> Insert both ends of the extraction tool under the plug (from the direction opposite to the Cable termination), as shown and pull-up in the direction perpendicular to the mounting surface of the receptacle.</p> <p>● Recommended the use of the extraction tool for unmating. Any attempt of unmating by pulling on the cable may result in damage and affect the mechanical / electrical performance.</p>  <p>• <b>Mating</b></p> <ol style="list-style-type: none"> <li>Align the mating tool W.FL-LP-IN or the mating end of the tool over the plug end of the cable assembly.</li> <li>Firmly place the tool over the plug until it is secured in the tool.</li> <li>Place the plug cable assembly (held in the tool) over the corresponding receptacle.</li> <li>Assuring that the plug and receptacle are aligned press-down perpendicular to the mounting surface until both connectors are fully mated.</li> <li>Remove the mating tool by carefully pulling it up. Removal of the tool.</li> </ol>  <p>Plug pickup → Insertion to a receptacle → Removal of the tool</p>
<p>(2) Pull forces on the cable after connectors are mated</p>	<p>After the connectors are mating, do not apply a load to the cable in excess of the values indicated in the diagram.</p> 
<p>(3) Precautions</p>	<p>Do not twist connectors excessively during mating / unmating.</p>

**2. Receptacle**

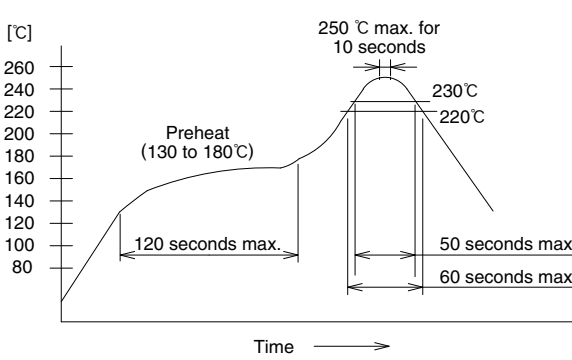
<p>(1) Recommended reflow temperature profile</p>	 <ol style="list-style-type: none"> <li>The temperature of the printed circuit board surface temperature at the points of contact with the terminals.</li> <li>Reflow soldering should be performed at a printed circuit surface temperature of 250°C max.</li> <li>In individual applications the actual temperature may vary, depending on the solder paste type, volume / thickness and board size / thickness. Consult your solder paste and equipment manufacturer for specific recommendations.</li> </ol>
<p>(2) Recommended metal mask thickness</p>	<p>0.1mm to 0.12mm</p>
<p>(3) Reflow cycles</p>	<p>2 times</p>

**3. Operating environment and storage conditions**

<p>(1) Operating environment</p>	<p>The connectors are not designed to operate in the following environments:</p> <ul style="list-style-type: none"> <li>Exposed to a excessive amounts of fine particles and dust</li> <li>Regions and places having a high density of sulfur dioxide, hydrogen sulfide, nitrogen dioxide or other corrosive gasses.</li> <li>Environments having large rapid variations in temperature.</li> </ul>
<p>(2) Storage conditions - Receptacle</p>	<p>Store in the Hirose Electric packaging. Temperature : -10 to +40°C, Humidity : 85% max. Use within 6 months of delivery. Receptacles for which the storage period has elapsed must be tested for solderability to the PC board mounting surface.</p>

Dec.1.2018 Copyright 2018 HIROSE ELECTRIC CO., LTD. All Rights Reserved.

**USA:**

**HIROSE ELECTRIC (U.S.A.), INC. HEADQUARTERS CHICAGO OFFICE**  
2300 Warrenville Road, Suite 150,  
Downers Grove, IL 60515  
Phone : +1-630-282-6700  
<http://www.hirose.com/us/>

**USA:**

**HIROSE ELECTRIC (U.S.A.), INC. SAN JOSE OFFICE**  
2841 Junction Ave, Suite 200  
San Jose, CA. 95134  
Phone : +1-408-253-9640  
Fax : +1-408-253-9641  
<http://www.hirose.com/us/>

**USA:**

**HIROSE ELECTRIC (U.S.A.), INC. DETROIT OFFICE (AUTOMOTIVE)**  
17197 N. Laurel Park Drive, Suite 253,  
Livonia, MI 48152  
Phone : +1-734-542-9963  
Fax : +1-734-542-9964  
<http://www.hirose.com/us/>

**USA:**

**HIROSE ELECTRIC (U.S.A.), INC. BOSTON OFFICE**  
300 Brickstone Square Suite 201,  
Andover, MA 01810  
Phone : +1-978-662-5255

**THE NETHERLANDS:**

**HIROSE ELECTRIC EUROPE B.V.**  
Hogehillweg #8 1101 CC Amsterdam Z-0  
Phone : +31-20-6557460  
Fax : +31-20-6557469  
<http://www.hirose.com/eu/>

**GERMANY:**

**HIROSE ELECTRIC EUROPE B.V. GERMAN BRANCH**  
Schoenbergstr. 20, 73760 ostfildern  
Phone : +49-711-456002-1  
Fax : +49-711-456002-299  
<http://www.hirose.com/eu/>

**GERMANY:**

**HIROSE ELECTRIC EUROPE B.V. NUREMBERG OFFICE**  
Neumeyerstrasse 22-26, 90411 Nurnberg  
Phone : +49-911 32 68 89 63  
Fax : +49-911 32 68 89 69  
<http://www.hirose.com/eu/>

**GERMANY:**

**HIROSE ELECTRIC EUROPE B.V. HANOVER OFFICE**  
Bayernstr. 3, Haus C 30855 Langenhagen, Germany  
Phone : +49-511 97 82 61 30  
Fax : +49-511 97 82 61 35  
<http://www.hirose.com/eu/>

**FRANCE:**

**HIROSE ELECTRIC EUROPE B.V. PARIS OFFICE**  
130 Avenue Joseph Kessel, Bat E, 78960  
Voisins le Bretonneux, France  
Phone : +33-1-85764886  
Fax : +33-1-85764823  
<http://www.hirose.com/eu/>

**UNITED KINGDOM:**

**HIROSE ELECTRIC EUROPE BV (UK BRANCH)**  
4 Newton Court, Kelvin Drive, Knowlhill,  
Milton Keynes, MK5 8NH  
Phone : +44-1908 202050  
Fax : +44-1908 202058  
<http://www.hirose.com/eu/>

**CHINA:**

**HIROSE ELECTRIC (CHINA) CO., LTD. (SHANGHAI, HEADQUARTERS)**  
18, Enterprise Center Tower 2, 209# Gong He  
Road, Jing'an District, Shanghai, CHINA 200070  
Phone : +86-21-6391-3355  
Fax : +86-21-6391-3335  
<http://www.hirose.com/cn/>

**CHINA:**

**HIROSE ELECTRIC (CHINA) CO.,LTD. BEIJING BRANCH**  
A1001, Ocean International Center, Building 56# East 4th  
Ring Middle Road, ChaoYang District, Beijing, 100025  
Phone : +86-10-5165-9332  
Fax : +86-10-5908-1381  
<http://www.hirose.com/cn/>

**CHINA:**

**HIROSE ELECTRIC (CHINA) CO., LTD. SHENZHEN BRANCH**  
Room 09-13, 19/F, Office Tower Shun Hing Square, Di Wang Commercial Centre,  
5002 Shen Nan Dong Road, Shenzhen City, Guangdong Province, 518008  
Phone : +86-755-8207-0851  
Fax : +86-755-8207-0873  
<http://www.hirose.com/cn/>

**HONG KONG:**

**HIROSE ELECTRIC HONGKONG TRADING CO., LTD.**  
Room 1001, West Wing, Tsim Sha Tsui Centre, 66  
Mody Road, Tsim Sha Tsui East, Kowloon, Hong Kong  
Phone : +852-2803-5338  
Fax : +852-2591-6560  
<http://www.hirose.com/hk/>

**TAIWAN:**

**HIROSE ELECTRIC TAIWAN CO., LTD.**  
103 8F, No.87, Zhengzhou Rd., Taipei  
Phone : +886-2-2555-7377  
Fax : +886-2-2555-7355  
<http://www.hirose.com/tw/>

**KOREA:**

**HIROSE KOREA CO.,LTD.**  
143, Gongdan 1-daero, Siheung-si,  
Gyeonggi-do, 15084, Korea  
Phone : +82-31-496-7000  
Fax : +82-31-496-7100  
<http://www.hirose.co.kr/>

**SINGAPORE:**

**HIROSE ELECTRIC SINGAPORE PTE. LTD.**  
03, Anson Road, #20-01, Springleaf Tower,  
Singapore 079909  
Phone : +65-6324-6113  
Fax : +65-6324-6123  
<http://www.hirose.com/sg/>

**INDIA:**

**HIROSE ELECTRIC SINGAPORE PTE. LTD. DELHI LIAISON OFFICE**  
Office NO.552, Regus-Green Boulevard, Level5, Tower C,  
Sec62, Plot B-9A, Block B, Noida, 201301, Uttar Pradesh, India  
Phone : +91-12-660-8018  
Fax : +91-120-4804949  
<http://www.hirose.com/sg/>

**INDIA:**

**HIROSE ELECTRIC SINGAPORE PTE. LTD. BANGALORE LIAISON OFFICE**  
Unit No-403, 4th Floor, No-84, Barton Centre, Mahatma  
Gandhi (MG) Road, Bangalore 560 001, Karnataka, India  
Phone : +91-80-4120 1907  
Fax : +91-80-4120 9908  
<http://www.hirose.com/sg/>

**MALAYSIA:**

**PENANG REPRESENTATIVE OFFICE**  
73-3-1, Ideal@The One, Jalan Mahsuri, Bayan  
Lepas Penang, 11950, Malaysia  
Phone : +604-648-5536  
<http://www.hirose.com/sg/>

**THAILAND:**

**BANGKOK OFFICE (REPRESENTATIVE OFFICE)**  
Unit 4703, 47th FL., 1 Empire Tower, South Sathorn  
Road, Yannawa, Sathorn, Bangkok 10120 Thailand  
Phone : +66-2-686-1255  
Fax : +66-2-686-3433  
<http://www.hirose.com/sg/>



**HIROSE ELECTRIC CO.,LTD.**

2-6-3,Nakagawa Chuoh,Tsuzuki-Ku,Yokohama-Shi 224-8540,JAPAN  
TEL: +81-45-620-3526 Fax: +81-45-591-3726  
<http://www.hirose.com>  
<http://www.hirose-connectors.com>



## X-ON Electronics

Largest Supplier of Electrical and Electronic Components

*Click to view similar products for [RF Cable Assemblies](#) category:*

*Click to view products by [Hirose](#) manufacturer:*

Other Similar products are found below :

[73-6352-10](#) [73-6353-3](#) [73-6364-6](#) [R285001001](#) [R288940004](#) [R288940005](#) [145111-05-12.00](#) [1661-C-24](#) [1801171170914KE](#) [24P104C24J1-012](#) [24P104C24P1-006](#) [24P104C24P1-018](#) [24P204C24J1-003](#) [172-2150-EX](#) [1800920920914PJ](#) [FCB-3030-ALT](#) [21117-046](#) [21117-050](#) [PCX-24-50](#) [24P103C24P2-003](#) [25P203C25P2-003](#) [PTWY-24-78](#) [R284008001](#) [R285001021](#) [R285426000](#) [R288940003](#) [R288940008](#) [RF179-74BJ3-77RP1-0305](#) [4814-BB-24](#) [5260-72](#) [JT2N1-CL1-1F](#) [DLP-COAX1](#) [4814-K-48](#) [115101-09-06.00](#) [CCNTN2-MM-LL335-26](#) [73-6351-25](#) [73-6352-3](#) [73-6353-25](#) [1800920920610PJ](#) [GD0BQ0BQ024.0](#) [1-3636-600-5210](#) [TL8A-11SMA-11SMA-01500-51](#) [R284C0351060](#) [R288940009](#) [R284C0351028](#) [R288940002](#) [9702-1SL-1](#) [PT82NSMA](#) [73-6353-10](#) [R285020301W](#)