

Sep.1.2021 Copyright 2021 HIROSE ELECTRIC CO., LTD. All Rights Reserved.  
In case of consideration for using Automotive equipment / device which demand high reliability, kindly contact our sales window correspondents.

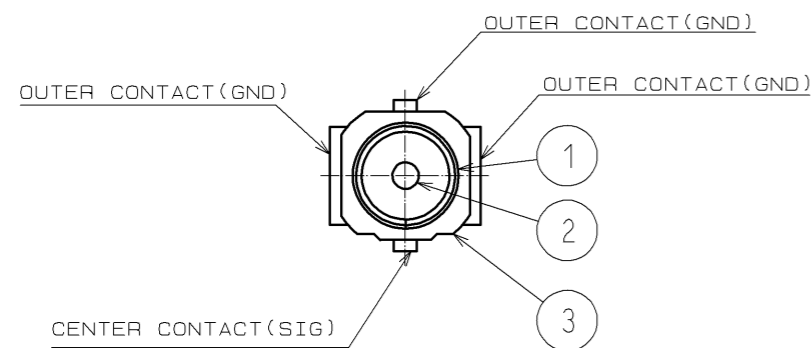

RECOMMENDED PCB LAYOUT (MOUNTING SURFACE SIDE)(5:1)

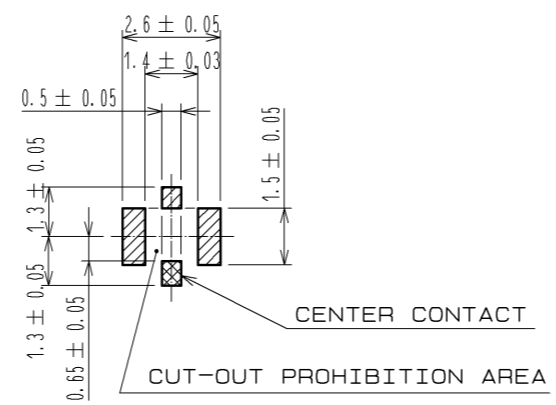

EMBOSSED TAPING DRAWING (4:1)

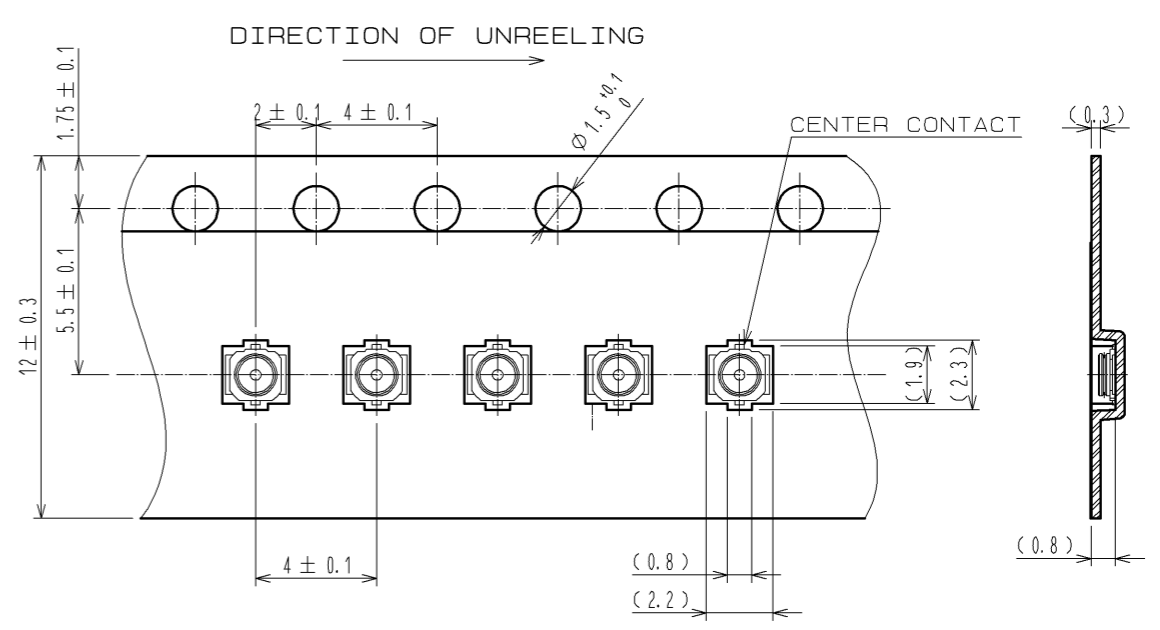

RECOMMENDED METAL MASK DIMENSIONS (5:1)  
METAL MASK THICKNESS: 0.1mm/0.12mm

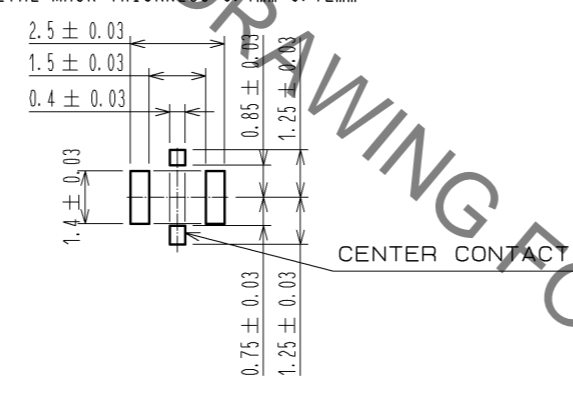

REEL DRAWING (SCALE FREE)

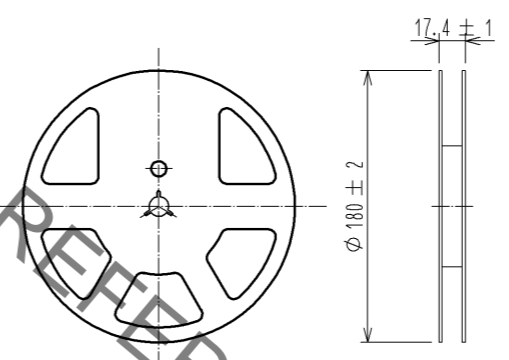

REFLOW TEMPERATURE PROFILE USING LEAD-FREE SOLDER PASTE (REFERENCE)

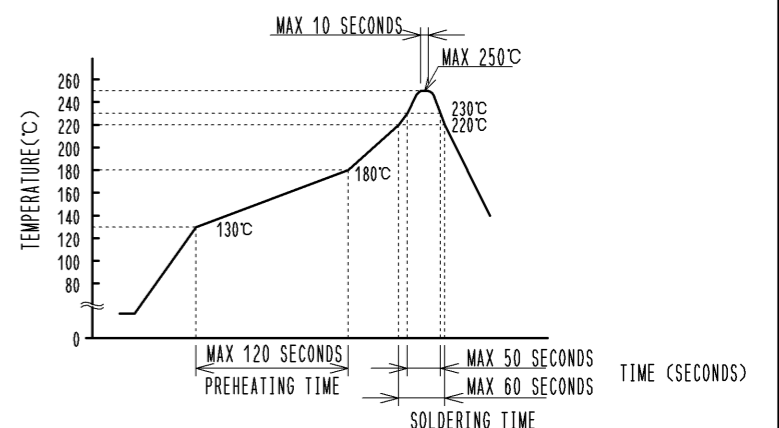

NOTES:

- 1: THE QUANTITY OF X.FL-R-SMT-1(02) IS 500 CONNECTORS PER REEL.
- 2: THIS DIMENSION SHOWS THE ALLOWABLE RANGE THAT THE RESIN IS PUT OVER THE CENTER CONTACT.
- 3: LEAD CO-PLANARITY SHALL BE 0.08MAX.
- 4: FOR THE POSSIBILITY OF BREAKAGE OR DEFORMATION DO NOT MATE THIS CONNECTOR WITH PARTNER, X.FL-LP-040 BEFORE MOUNTING ON PC BOARD.
- 5: USE ALL PRODUCTS WITHIN 6 MONTHS AFTER THE DELIVERY. STORE THEM IN MANUFACTURER'S PACKAGE OR TIGHTLY RE-CLOSED BOX WITH THE FOLLOWING CONDITIONS. CHECK THE TERMINAL SOLDERABILITY BEFORE USE IF THE PRODUCT HAS BEEN STORED FOR MORE THAN 6 MONTHS.  
TEMPERATURE: -10°C TO +40°C  
HUMIDITY : 15 TO 85% RH.
- 6: ENVIRONMENTAL CONDITIONS DO NOT USE THE PRODUCTS UNDER THE ENVIRONMENTAL CONDITIONS AS SHOWN BELOW DUE TO POSSIBLE PRODUCT DETERIORATION.  
SPECIAL GAS ATMOSPHERE (HYDROGEN SULFIDE GAS, SULFUR SULFIDE GAS AND HYDROGEN CHLORIDE GAS)  
PLACE ATTENTION REQUIRED: HEATING SYSTEM, AREA NEAR HOT SPRING, VOLCANIC MOUNTAIN AND ALIKE.  
WATER SPLASHED AND CONDENSATION PLACES.  
PLACE ATTENTION REQUIRED: HARSH TEMPERATURE CHANGE.

A (SCALE FREE)

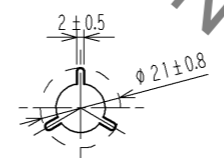

ROHS COMPLIANT

- 1) REFLOW TIME  
REFLOW METHOD : IR REFLOW  
NUMBER OF REFLOW CYCLES : 2 CYCLES MAX.  
DURATION ABOVE 220 °C : 60 SEC. MAX.  
DURATION ABOVE 230 °C : 50 SEC. MAX.  
(PEAK TEMPERATURE : 250°C 10 SEC. MAX.)
- 2) PRE-HEAT TIME  
PRE-HEAT TEMPERATURE(MIN) : 130 °C  
PRE-HEAT TEMPERATURE(MAX) : 180 °C  
PRE-HEAT TIME: 120 SEC. MAX.

THIS TEMPERATURE PROFILE IS PER THE CONDITIONS SHOWN ABOVE. ADDITIONAL FACTORS, SUCH AS SOLDER PASTE TYPE, PCB SIZE AND OTHER MOUNTED COMPONENTS COULD AFFECT THE PROFILE. THEREFORE, A THOROUGH EVALUATION OF MOUNTING CONDITION IS REQUIRED PRIOR TO PRODUCTION. TEMPERATURE IS MEASURED AT CONTACT LEAD.

1		PHOSPHOR BRONZE	UNDER PLATING:NICKEL OVER PLATING:SELECTIVE GOLD	3		LCP	(BLACK), UL94V-0
2		BRASS	UNDER PLATING:NICKEL OVER PLATING:SELECTIVE GOLD	4		BRASS	UNDER PLATING:NICKEL OVER PLATING:SELECTIVE GOLD
NO.	MATERIAL	FINISH . REMARKS		NO.	MATERIAL	FINISH . REMARKS	
UNITS	mm	SCALE	10:1	COUNT	DESCRIPTION OF REVISIONS	DESIGNED	CHECKED
APPROVED : KY. SHIMIZU		14.09.18		DRAWING NO.		EDC3-318791-02	
CHECED : MT. KANEKO		14.09.18		PART NO.		X.FL-R-SMT-1(02)	
DESIGNED : MS. MATSUMOTO		14.09.18		CODE NO.		CL331-0701-8-02	
DRAWN : MS. MATSUMOTO		14.09.18					

## X-ON Electronics

Largest Supplier of Electrical and Electronic Components

*Click to view similar products for [RF Connectors / Coaxial Connectors](#) category:*

*Click to view products by [Hirose](#) manufacturer:*

Other Similar products are found below :

[8915-1511-000](#) [89674-0827](#) [6001-7071-019](#) [6002-7051-003](#) [6002-7551-202](#) [6059674-1](#) [619550-1](#) [630059-000](#) [M39030/3-01N](#) [M3933/25-36N](#) [6500-7071-046](#) [6769](#) [CX050L2AQ](#) [7002-1542-011](#) [7004-1512-000](#) [7009-1511-004](#) [7010-1511-000](#) [7029-1511-060](#) [7101-1541-010](#) [7101-1571-002](#) [7105-1521-002](#) [7145-1521-002](#) [7203-1571-003](#) [7209-1511-011](#) [7210-1511-015](#) [7210-1511-019](#) [73137-5015](#) [73216-2241](#) [7325-1512-000](#) [73404-2300](#) [7405-1521-005](#) [7405-1521-802](#) [7406-1521-005](#) [8527](#) [8547](#) [FS11V](#) [8808-1511-001](#) [9049-9513-000](#) [9074-9513-000](#) [9101-9573-002](#) [910A205F](#) [9130-9573-002](#) [PL11SC-026](#) [PL375-33](#) [PL40-5](#) [PL71-9](#) [PL74C-221](#) [PL75MC-217](#) [PL803-7](#) [980-8666-005](#)