



Product information GDS 207 schwarz/black

Industrial Connecting Solutions:Rectangular Connectors:Valve Connectors (Type A -B -C):Type C:Field Attachable Valve Connectors:Valve Connectors (Industrial standard):GDS 207 schwarz/black

<https://www.e-catalog.beldensolutions.com:443/link/57078-24228-256261-256266-256272-276221-24344-35391/en/conf/uisstate>

Name	GDS 207 schwarz/black
	
	cable socket with central screw M 3 x 28
Delivery informations	
Availability	available
Product description	
Description	cable socket with central screw M 3 x 28
Type	GDS 207 schwarz/black
Order No.	933 138-100
Other standard types	grey housing, Order No. 933 138-106
Number of contacts	2 + PE
Cable gland	PG 7
Conductor size	max. 0.75 mm ²
Standard	industrial standard (9,4 mm)
Housing Color	black
Construction type	C
Technical data	
Pin dimensions	2,8 mm x 0,5 mm, 3,6 mm x 0,5 mm
Rated voltage	AC/DC 250 V
Rated current	6 A
Contact resistance	<= 4 mOhm
Type of termination	screw
Suitable cables	4.5 mm to 6 mm diameter
Mounting	central screw
Material	
Contact surface material	Sn
Contact bearer material	PA
Housing material	PA
Environmental conditions	
Protection class (IEC 60529)	IP 65
Pollution severity	3
Temperature range	-40 °C to +125 °C
Inflammability class	
Housing	94 HB
Contact bearer	94 V-2
Approvals	
UR	UR
VDE	VDE
SEV	SEV
CSA	CSA
Packaging unit	
Packaging unit	200 pieces
Scope of delivery and accessories	
Accessories to order separately	(NBR) flat gasket GDS 307-2, Order No. 730 185-002; (EPDM) flat gasket GDS 307-4, Order No. 730 314-004

Picture
Drawing

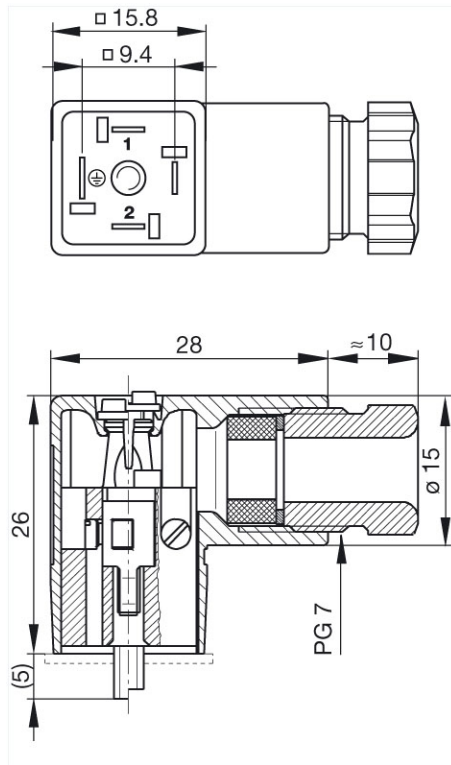

Belden Deutschland GmbH
 Im Gewerbepark 2
 58579 Schalksmühle
 Germany
 Phone: +49 7127/14-1806
 E-Mail: icos-sales@belden.com

The information published in the websites has been compiled as carefully as possible. It is subject to alteration without notice in technical as well as in price-related/commercial respect. The complete information and data were available on user documentation. Mandatory information can only be obtained by a concrete query.

X-ON Electronics

Largest Supplier of Electrical and Electronic Components

Click to view similar products for [Hirschmann](#) manufacturer:

Other Similar products are found below :

[932792001](#) [972337002](#) [XWA164](#) [931824-102](#) [PRUEF1RT](#) [932507005](#) [XZC 0704](#) [934061109](#) [934084102](#) [934158101](#) [934174103](#)
[972342001](#) [973369101](#) [LAS N WS AU GN](#) [N 6 R AM](#) [GMN 209 NJ BLACK](#) [STAS 4N GREY](#) [EAGLE40-2TX/1SFP](#) [934082101](#)
[934069100](#) [934061702](#) [932430100](#) [GSAZ 300](#) [EAGLE40-2TX/1SFP-EEC](#) [934094103](#) [975695702](#) [972355107](#) [934075109](#) [934066103](#)
[934080100](#) [934184100](#) [973929000](#) [975017700](#) [SLS 200 GN](#) [933003001](#) [934087107](#) [972338001](#) [931298006](#) [PRUEF2700RT](#) [938115101](#)
[SEB 2600 G M4 GE](#) [PMS 2](#) [MICROSMDCLIP1](#) [PRUEF 2600 C2 RT](#) [934077105](#) [EF12M5FIX AU](#) [934093104](#) [972319101](#) [931297006](#)
[934176101](#) [MLNSIL150/1RT](#) [934087102](#)