



GDM Series Rectangular Connectors, Type B, Field Attachable Female Connectors, DIN Standard and Industrial Standard, without Protection Circuit







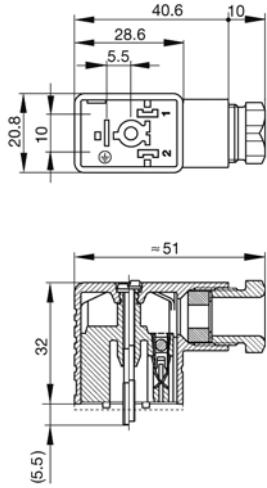
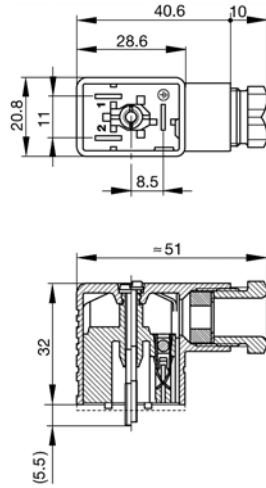

















Technical Information

Product Description		
Order Designation	GMN 2XX NJ	GM 2XX NJ
		
Description	Valve connector GDM series, type B, DIN standard, without LED, without circuit	Valve connector GDM series, type B, industrial standard, without LED, without circuit
RoHS-Compliant (2011/65/EU)	Yes	
(Construction Type) Standard	DIN EN 175 301-803-B	Industrial standard
Approvals	VDE/(UL)	
Connectible Cables	Ø 4.5 to 7 mm	
Conductor Size	max. 1.5 mm ²	
Technical Data		
No. of Pins	2 + PE	
Ambient Temperature	-40 °C to +125 °C	
Housing/Grip/Screw Coupling	PA	
Contact Holder	PA	
Contact	CuZn, tin-plated	
Mechanical Data		
Degree of Protection	IP65 (only when mated with Hirschmann/Lumberg counterparts)	
Terminal Type	Screw/terminal lug/crimp ring	
Electrical Data		
Circuit	No protection circuit, no LED	
Contact Resistance	≤ 4 mΩ	
Rated Voltage	250 V AC/DC	
Rated Current	2 A	
Pollution Degree	3	
Accessories		
Accessories to be Ordered Separately	(NBR) flat gasket GMN 209-3, Order-No: 733273002 (EPDM) flat gasket GMN 209-12, Order-No: 733271004 Knurled screw GDM 3011-8, Order No. 732574001 Stainless steel screw GDM 3011 RF-1, Order No. 734363001	(NBR) flat gasket GM 207-3, Order-No: 731423002 (EPDM) flat gasket GM 207-7, Order-No: 731755004 Knurled screw GDM 3011-8, Order No. 732574001 Stainless steel screw GDM 3011 RF-1, Order No. 734363001

Technical Drawing		
		

Be Certain with Belden

Order Information

Order No.	Order Designation	No. of Pins	Circuit	Cable Gland	Rated Voltage	Rated Current	Characteristics
932987100	GMN 209 NJ black	2 + PE	No protection circuit	PG9	250 V AC/DC	2 A	  
932987106	GMN 209 NJ gray	2 + PE	No protection circuit	PG9	250 V AC/DC	2 A	  
934457100	GMN 216 NJ black	2 + PE	No protection circuit	M16	250 V AC/DC	2 A	  
934457106	GMN 216 NJ gray	2 + PE	No protection circuit	M16	250 V AC/DC	2 A	  
932977100	GM 209 NJ black	2 + PE	No protection circuit	PG9	250 V AC/DC	2 A	  
932977106	GM 209 NJ gray	2 + PE	No protection circuit	PG9	250 V AC/DC	2 A	  
934456100	GM 216 NJ black	2 + PE	No protection circuit	M16	250 V AC/DC	2 A	  
934456106	GM 216 NJ gray	2 + PE	No protection circuit	M16	250 V AC/DC	2 A	  

X-ON Electronics

Largest Supplier of Electrical and Electronic Components

Click to view similar products for [Sensor Cables / Actuator Cables](#) category:

Click to view products by [Hirschmann](#) manufacturer:

Other Similar products are found below :

[60963](#) [60964](#) [703000D02F2002](#) [703001D02F0602](#) [703001D02F1201](#) [703001D02F300](#) [704000D02F120](#) [MDM21SH001F](#) [773032K02F030](#)
[802027107404-1](#) [802027213811-1](#) [804001A09M150](#) [805001A09M0502](#) [84914-0235](#) [84914-0237](#) [885030A09M010](#) [8R4006A18M010](#)
[8R4J30E03C3003](#) [1200651713](#) [1200660844](#) [1200660845](#) [1200661173](#) [1200680071](#) [1200720053](#) [1200720081](#) [1200720094](#) [1200720099](#)
[1200720217](#) [1200800231](#) [1200860125](#) [1200870123](#) [1200660183](#) [1200660782](#) [1200660849](#) [1200661295](#) [1200661297](#) [1200661342](#)
[1200661343](#) [1200670080](#) [1200680331](#) [1200720252](#) [1200720255](#) [1200720597](#) [1200730184](#) [1200860344](#) [1200870359](#) [1200870643](#)
[1200980008](#) [1200980031](#) [1210502211](#)