



User Manual

Installation

Industrial ETHERNET Rail Switch

SPIDER II, SPIDER II Giga, SPIDER II PoE

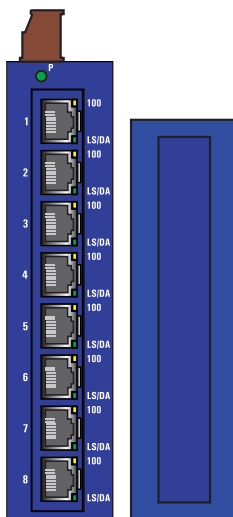

SPIDER II 8TX
SPIDER II 8TX EEC

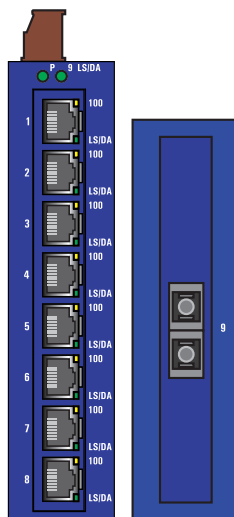

SPIDER II 8TX/1FX EEC
SPIDER II 8TX/1FX-SM EEC

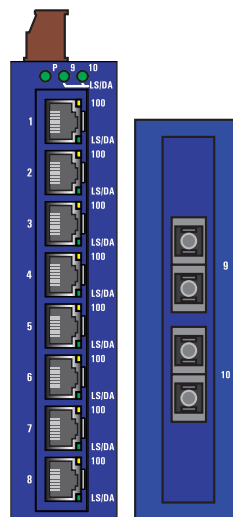

SPIDER II 8TX/2FX EEC
SPIDER II 8TX/2FX-SM EEC

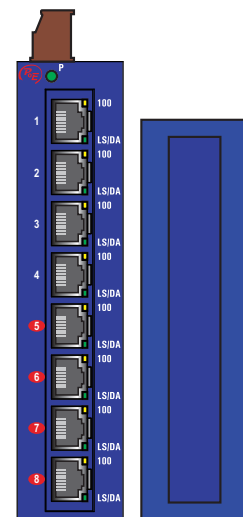

SPIDER II 8TX PoE

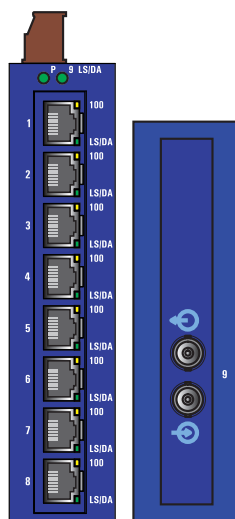

SPIDER II 8TX/1FX-ST EEC

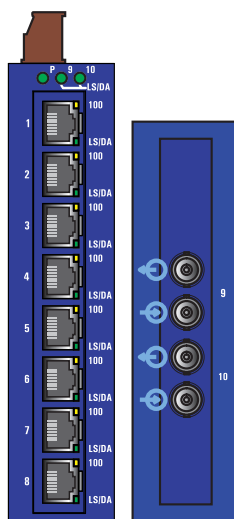

SPIDER II 8TX/2FX-ST EEC

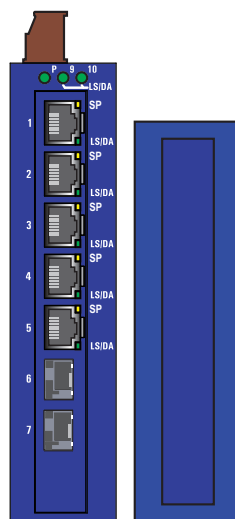

SPIDER II Giga 5T/2S EEC

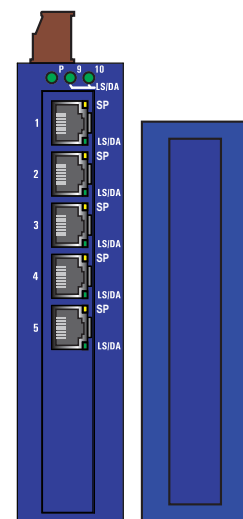

SPIDER II Giga 5T EEC

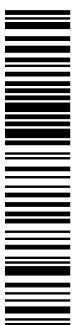

039709001040909000

The naming of copyrighted trademarks in this manual, even when not specially indicated, should not be taken to mean that these names may be considered as free in the sense of the trademark and tradename protection law and hence that they may be freely used by anyone.

© 2009 Hirschmann Automation and Control GmbH

Manuals and software are protected by copyright. All rights reserved. The copying, reproduction, translation, conversion into any electronic medium or machine scannable form is not permitted, either in whole or in part. An exception is the preparation of a backup copy of the software for your own use. For devices with embedded software, the end-user license agreement on the enclosed CD applies.

The performance features described here are binding only if they have been expressly agreed when the contract was made. This document was produced by Hirschmann Automation and Control GmbH according to the best of the company's knowledge. Hirschmann reserves the right to change the contents of this document without prior notice. Hirschmann can give no guarantee in respect of the correctness or accuracy of the information in this document.

Hirschmann can accept no responsibility for damages, resulting from the use of the network components or the associated operating software. In addition, we refer to the conditions of use specified in the license contract.

You can get the latest version of this manual on the Internet at the Hirschmann product site (www.hirschmann-ac.de).

Printed in Germany
Hirschmann Automation and Control GmbH
Stuttgarter Str. 45-51
72654 Neckartenzlingen
Germany
Tel.: +49 1805 141538

Content

Safety instructions	4
Legend	8
1 Device description	9
1.1 Description of the device variants	10
2 Assembly and start-up	14
2.1 Installing the device	14
2.1.1 Unpacking and checking	14
2.1.2 Installing the SFP modules (if present)	15
2.1.3 Connecting the terminal block for the supply voltage and the grounding	15
2.1.4 Mounting the device on the DIN rail	16
2.1.5 Dimensions	17
2.1.6 Installing the terminal block, start-up procedure	17
2.1.7 Connecting the data lines	17
2.2 Display elements	20
2.2.1 Device state	20
2.2.2 Port state	20
2.3 Disassembly	21
2.3.1 Removing the device from the DIN rail	21
2.3.2 Disassembling the SFP modules	22
3 Technical data	23
Further support	28

Safety instructions

■ Notes on safety

This manual contains instructions to be observed for ensuring your personal safety and for preventing damage. The warnings appear next to a warning triangle with a different heading depending on the degree of danger posed:



Danger!

Means that death, serious physical injury or significant damage to property **will occur** if the corresponding safety measures are not carried out.



Warning!

Means that death, serious physical injury or significant damage to property **could occur** if the corresponding safety measures are not carried out.



Caution!

Means that minor physical injury or damage to property can occur if the required safety measures are not carried out.

Note: Contains important information on the product, on how to manage the product, or on the respective section of the documentation to which your special attention is being drawn.

■ Certified usage

Please observe the following: The device may only be employed for the purposes described in the catalog and technical description, and only in conjunction with external devices and components recommended or approved by the manufacturer. The product can only be operated correctly and safely if it is transported, stored, installed and assembled properly and correctly. Furthermore, it must be operated and serviced carefully.

■ Supply voltage

The devices are designed for operation with a safety extra-low voltage. Accordingly, only SELV circuits with voltage restrictions in line with IEC/EN 60950-1 may be connected to the supply voltage connections.



Warning!

Only connect a supply voltage that corresponds to the type plate of your device.

Use only undamaged parts.

- If you are operating the module with an external voltage, only supply the system with a safety extra-low voltage in compliance with IEC/EN 60950-1.
- Connect the ground connector before you set up the other connections. When removing the connections, you remove the ground connector last.
- Relevant for North America: To be used in class 2 circuits.
The device may only be connected to a supply voltage of class 2 that fulfills the requirements of the National Electrical Code, Table 11(b).
- Relevant for North America: For use in Class 2 circuits.
Only use copper wire/conductors of class 1, 60/75°C or 90 °C.
- Relevant for North America
for devices certified for hazardous locations:
Power, input and output (I/O) wiring must be in accordance with Class I, Division 2 wiring methods [Article 501-4(b) of the National Electrical Code, NFPA 70] and in accordance with the authority having jurisdiction.
- Only switch on the device when the housing is closed.

■ **Shielding ground**

- Beware of possible short circuits when connecting a cable section with conductive shielding braiding.

■ **Housing**

Only technicians authorized by Hirschmann are permitted to open the housing.

Note: The device is grounded by means of a 3-pin terminal block.

- Make sure that the electrical installation meets local or nationally applicable safety regulations.
- The ventilation slits must not be covered so as to ensure free air circulation.
- The clearance to the ventilation slits of the housing must be at least 10 cm (3.94 in).
- The device must be installed in the vertical position.
- If installed in a living area or office environment, the device must be operated exclusively in switch cabinets with fire protection characteristics in accordance with EN 60950-1.



Warning!

Never insert sharp objects (small screwdrivers, wires, etc.) into the inside of the product. There is the risk of an electric shock.

■ **Environment**

The device may only be operated at the specified maximum ambient temperature (temperature of the ambient air at a distance of up to 5 cm (1.97 in) from the device) and relative air humidity.

- Install the device in a location where the climatic threshold values specified in the technical data are adhered to.
- Only to be used in an environment with the contamination level specified in the technical data.

■ **Qualification requirements for personnel**

Qualified personnel as understood in this manual and the warning signs, are persons who are familiar with the setup, assembly, startup, and operation of this product and are appropriately qualified for their job. This includes, for example, those persons who have been:

- ▶ trained or directed or authorized to switch on and off, to ground and to label power circuits and devices or systems in accordance with current safety engineering standards;
- ▶ trained or directed in the care and use of appropriate safety equipment in accordance with the current standards of safety engineering;
- ▶ trained in providing first aid.

■ **General safety instructions**

Electricity is used to operate this equipment. Comply in every detail with the safety requirements specified in the operating instructions regarding the voltages to apply (refer to page 4).

Non-observance of these safety instructions can therefore cause material damage and/or serious injuries.

- Only appropriately qualified personnel should work on this device or in its vicinity. These personnel must be thoroughly familiar with all the warnings and maintenance procedures in accordance with this operating manual.
- The proper and safe operation of this device depends on proper handling during transport, proper storage and assembly, and conscientious operation and maintenance procedures.
- Never start operation with damaged components.
- Only use the devices in accordance with this manual. In particular, observe all warnings and safety-related information.
- Any work that may be required on the electrical installation may only be carried out by personnel trained for this purpose.

Relevant for SPIDER II 8 TX/...FX... EEC and SPIDER II Giga 5T/2S EEC:

Note:

LED or LASER components in compliance with IEC 60825-1 (2001):

CLASS 1 LASER PRODUCT

CLASS 1 LED PRODUCT

■ **National and international safety regulations**

- Make sure that the electrical installation meets local or nationally applicable safety regulations.

■ **Note on the CE marking**

The devices comply with the regulations contained in the following European directive(s):

2006/95/EG, 2004/108/EG

Directive of the European Parliament and the council for standardizing the regulations of member states with regard to electromagnetic compatibility.

72/245/EWG, 2006/28/EG

Guideline for standardizing the regulations of member states relating to radio interference from motor vehicles. Certified devices are marked with an e1 type approval indicator.

In accordance with the above-named EU directive(s), the EU conformity declaration will be at the disposal of the relevant authorities at the following address:

Hirschmann Automation and Control GmbH
Stuttgarter Str. 45-51
72654 Neckartenzlingen
Tel.: +49 1805 141538

The product can be used in living areas (living area, place of business, small business) and in industrial areas.

- ▶ Interference immunity: EN 61000-6-2:2005
- ▶ Emitted interference: EN 55022:2006 Class A



Warning

This is a class A device. This device can cause interference in living areas, and in this case the operator may be required to take appropriate measures.

The assembly guidelines provided in these instructions must be strictly adhered to in order to observe the EMC threshold values.

■ **FCC note:**

Appropriate testing has established that this device fulfills the requirements of a class A digital device in line with part 15 of the FCC regulations.

These requirements are designed to provide sufficient protection against interference when the device is being used in a business environment.

The device creates and uses high frequencies and can radiate same, and if it is not installed and used in accordance with this operating manual, it can cause radio transmission interference. The use of this device in a living area can also cause interference, and in this case the user is obliged to cover the costs of removing the interference.

■ **Recycling note**

After usage, this product must be disposed of properly as electronic waste in accordance with the current disposal regulations of your county / state / country.

Legend

The commendations used in this manual have the following meanings:

▶	Listing
□	Work step
■	Subheading

1 Device description

The SPIDER II devices are designed for the special requirements of industrial automation. They meet the relevant industry standards, provide very high operational reliability, even under extreme conditions, and also long-term reliability and flexibility.

The devices allow you to set up switched industrial ETHERNET networks that conform to the IEEE 802.3 and 802.3u standards using copper wires or optical fibers in a line structure.

The SPIDER II 8TX... devices have, depending on the variant, eight TP ports (10/100 Mbit/s, RJ45 socket) and up to two 100 Mbit/s F/O ports (100BASE-FX, DSC or ST connection). The SPIDER II Giga... devices have, depending on the variant, five TP ports (10/100/1000 Mbit/s, RJ45 socket) and up to two 1000 Mbit/s F/O ports (1000BASE-SX/LX, SFP slot).

The SPIDER II 8TX PoE devices support Power over ETHERNET (PoE) according to IEEE 802.3af.

They allow the connection and remote supply of, for example, IP telephones (Voice over IP), webcams, sensors, printer servers and WLAN access points via 10BASE-T/100BASE-TX. With PoE, these terminal devices are powered by the twisted-pair cable.

Mount the devices by

- ▶ simply snapping them onto a DIN rail

Depending on the device variant, you can choose various media to connect terminal devices and other infrastructure components:

- ▶ twisted pair cable
- ▶ multimode F/O
- ▶ singlemode F/O

The twisted pair ports support:

- ▶ Autocrossing
- ▶ Autonegotiation
- ▶ Autopolarity

The F/O ports support:

- ▶ Full duplex mode

The Hirschmann network components help you to establish continuous communication across all levels of the company. Connect your devices to:

- ▶ devices of the MICE family
- ▶ backbone devices of the MICE family
- ▶ the BAT wireless transmission system
- ▶ the EAGLE security system
- ▶ products for the LION control room / MACH 100 family

1.1 Description of the device variants

The devices differ with regard to the number of interfaces and the media type for connecting segments.

The table below shows the number and type of the ports for each product variant. The abbreviations F/O (optical fiber) and TP (twisted pair) indicate the media type. The abbreviations DSC, ST, SFP and RJ45 indicate the socket type. The abbreviations MM (Multimode) and SM (Singlemode) indicate the optical fiber type.

Variant	10/100 Mbit/s, TP, RJ45	PoE ports included	100 Mbit/s, F/O, MM, DSC	100 Mbit/s, F/O, SM, DSC	100 Mbit/s, F/O, MM, ST	10/100/ 1000 Mbit/s, TP, RJ45	1000 Mbit/s, F/O, SFP
SPIDER II 8TX	8						
SPIDER II 8TX EEC	8						
SPIDER II 8TX/1FX EEC	8		1				
SPIDER II 8TX/1FX-SM EEC	8			1			
SPIDER II 8TX/2FX EEC	8		2				
SPIDER II 8TX/2FX-SM EEC	8			2			
SPIDER II 8TX/1FX-ST EEC	8				1		
SPIDER II 8TX/2FX-ST EEC	8				2		
SPIDER II Giga 5T EEC						5	
SPIDER II Giga 5T/2S EEC						5	2
SPIDER II 8TX PoE		4					

Table 1: Number and type of ports

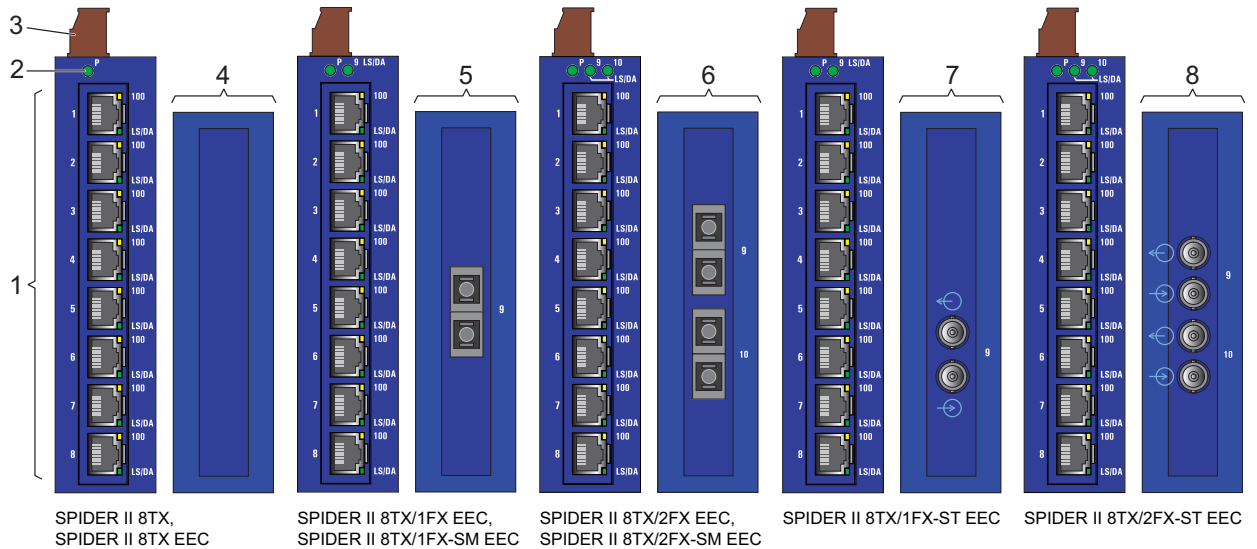

Figure 1: Overview of the device variants without gigabit ports (SPIDER II 8TX...)
 1 – Ports 1 to 8: ports in compliance with 10/100BASE-T(X) (RJ45 connections)

2 – LED display elements

3 – Plug-in terminal block, 3-pin

4 – Bottom of device: no ports

5 – Port 9 on bottom of device:

SPIDER II 8TX/1FX EEC: Multimode FX, DSC, 100 Mbit/s

SPIDER II 8TX/1FX-SM EEC: Singlemode FX, DSC, 100 Mbit/s

6 – Ports 9 and 10 on bottom of device:

SPIDER II 8TX/2FX EEC: 2 x Multimode FX, DSC, 100 Mbit/s

SPIDER II 8TX/2FX-SM EEC: 2 x Singlemode FX, DSC, 100 Mbit/s

7 – Port 9 on bottom of device:

Multimode FX, ST, 100 Mbit/s

8 – Ports 9 and 10 on bottom of device:

2 x Multimode FX, ST, 100 Mbit/s

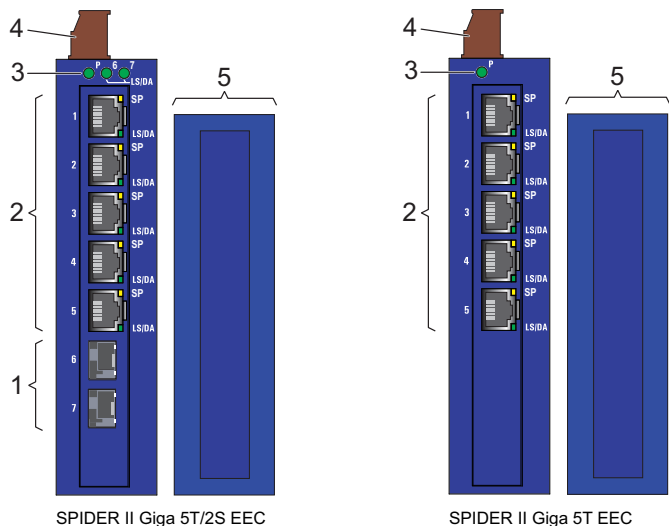

Figure 2: Overview of the device variants with gigabit ports (SPIDER II GIGA...)

- 1 – Ports 6 and 7: 2 x SX/LX, SFP slot, 1000 Mbit/s
- 2 – Ports 1 to 5: ports in compliance with 10/100/1000BASE-T(X) (RJ45 connections)
- 3 – LED display elements
- 4 – Plug-in terminal block, 3-pin
- 5 – Bottom of device: no ports

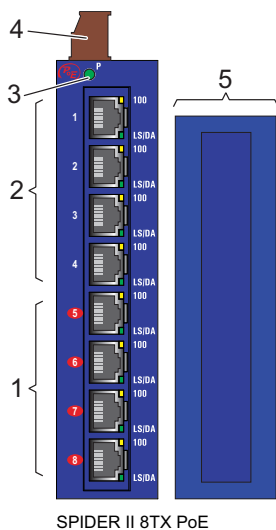

Figure 3: Overview of the device variants with PoE (SPIDER II 8TX PoE)

- 1 – Ports 5 to 8: ports in compliance with 10/100BASE-T(X) (RJ45 connections) with PoE (Power over Ethernet, phantom supply)
- 2 – Ports 1 to 4: ports in compliance with 10/100BASE-T(X) (RJ45 connections)
- 3 – LED display element
- 4 – Plug-in terminal block, 3-pin
- 5 – Bottom of device: no ports

Device variants SPIDER II 8TX PoE support Power over Ethernet (PoE) in accordance with IEEE 802.3af.

They allow the connection and remote supply of, for example, IP telephones (Voice over IP), webcams, sensors, printer servers and WLAN access points via 10BASE-T/100BASE-TX. With PoE, these terminal devices are powered by the twisted-pair cable.

The SPIDER II 8TX PoE devices provide four 10BASE-T/100BASE-TX ports (RJ45 sockets) for connecting network segments or PoE terminal devices (PD, Powered Device) for all IEEE802.3af classes up to a maximum power output of 15.4 W.

The 4 PoE-capable ports are the 4 bottom ports of the device (see [fig. 3](#)). On the device, the PoE ports are highlighted in red.

The current is supplied on wire pairs transmitting the signal; the individual ports are not electrically insulated from each other.

The following conditions are met in accordance with IEEE 802.3af:

- ▶ Endpoint PSE
- ▶ Alternative A

The devices also provide you with the following options for selecting the variant you desire:

Operating temperature	Standard	0 °C to +60 °C
	Extended	-40 °C to +70 °C

The following data applies in a cross-variant manner:

Operating voltage	SPIDER II without PoE	9.6 to 32.0 V DC
	SPIDER II 8TX PoE	18.0 to 32.0 V DC Safety extra-low voltage (SELV) Relevant for North America: Nec Class 2 power source max. 5A.
Software variant		Unmanaged
Certifications / declarations	pending	UL508 (E175531)

The devices comply with the specifications of the standard(s):

- ▶ ISO/IEC 8802-03 10BASE-T/100BASE-TX/1000BASE-T
- ▶ ISO/IEC 8802-03 100BASE-FX
- ▶ ISO/IEC 8802-03 1000BASE-SX/LX

2 Assembly and start-up

The devices have been developed for practical application in a harsh industrial environment. The installation process is correspondingly simple. On delivery, the device is ready for operation.

The following steps should be performed to install and configure a switch:

- ▶ Unpacking and checking
- ▶ Installing the SFP modules
- ▶ Connecting the terminal block for the supply voltage and the grounding
- ▶ Mounting the device on the DIN rail
- ▶ Install the terminal block, start-up procedure
- ▶ Installing the data lines

2.1 Installing the device

2.1.1 Unpacking and checking

- Check whether the contents of the package are complete ([see page 25 „Scope of delivery“](#)).
- Check the individual parts for transport damage.

2.1.2 Installing the SFP modules (if present)

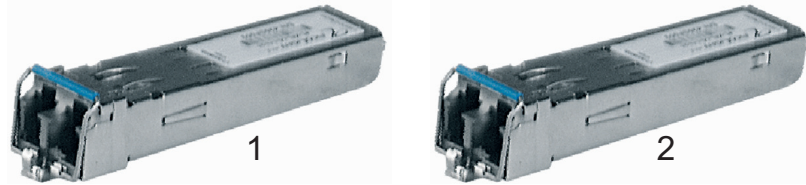

Figure 4: 1 - Fast EHTERNET fiber optic SFP module
2 - Gigabit ETHERNET fiber optic SFP module

- To attach an SFP module, first remove the protective cap over the socket.
- Push the SFP module with the lock closed into the socket until it latches audibly in place.

Note: Only use Hirschmann SFP modules ([see page 26 „Accessories“](#)).

2.1.3 Connecting the terminal block for the supply voltage and the grounding

A 3-pin terminal block is used for the grounding and for connecting the supply voltage.



Warning!

Only connect a supply voltage that corresponds to the type plate of your device.

Note: Relevant for North America:

The tightening torque of the terminal screws is max. 4.4 lb in. (0.5 Nm).

Figure	Pin	Assignment	Voltage range
	1	+ 24 V	9.6 to 32.0 V DC (18.0 to 32.0 V DC for SPIDER II 8TX PoE)
	2	0 V	
	3	Ground connection	

Table 2: Pin assignment of the 3-pin terminal block for the supply voltage

- Pull the terminal block off the device.
- Connect the supply voltage lines.
- Connect the ground connection.

2.1.4 Mounting the device on the DIN rail

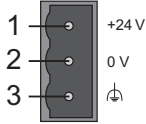

Caution!

Do not open the housing.

Note: The device is grounded by means of a 3-pin terminal block.

Note: The shielding ground of the connectable twisted pair lines is connected to the ground connection as a conductor.

- Mount the device on a 35 mm DIN rail in accordance with DIN EN 60175.
- Attach the upper snap-in guide of the device into the DIN rail and press it down against the DIN rail until it snaps into place.

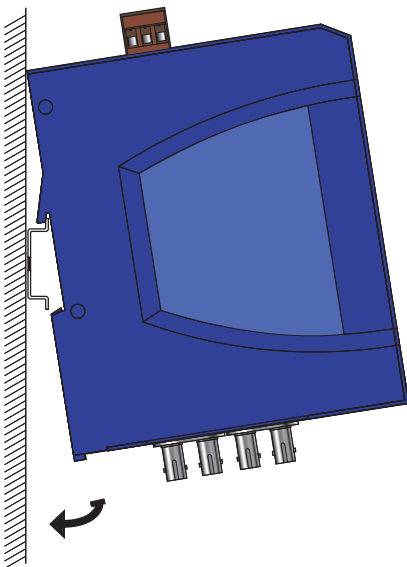

Figure 5: Mounting on the DIN rail

2.1.5 Dimensions

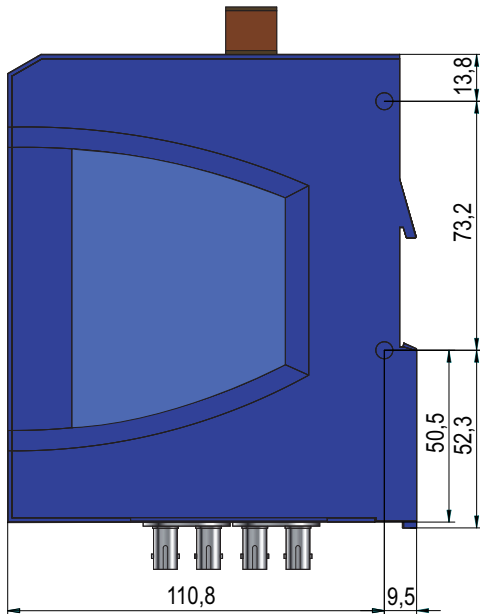

Figure 6: Dimensions of the SPIDER II

2.1.6 Installing the terminal block, start-up procedure



Warning!

Only connect a supply voltage that corresponds to the type plate of your device.

- Mount the terminal block for the supply voltage and the ground connection.

By connecting the voltage supply via the terminal block, you start the operation of the device.

2.1.7 Connecting the data lines

You can connect terminal devices and other segments at the ports of the device via twisted pair cables and F/O cables.

- Install the data lines according to your requirements.

■ 10/100 Mbit/s twisted pair connection

These connections are RJ45 sockets.

10/100 Mbit/s TP ports enable the connection of terminal devices or independent network segments according to the IEEE 802.3 10BASE-T/100BASE-TX standard.

These ports support:

- ▶ Autonegotiation
- ▶ Autopolarity
- ▶ Autocrossing

- ▶ 100 Mbit/s half-duplex mode, 100 Mbit/s full duplex mode
- ▶ 10 Mbit/s half-duplex mode, 10 Mbit/s full duplex mode

Figure	Pin	Function
	1+2	One line pair
	3+6	One line pair
	4,5,7,8	Not used

Table 3: Pin assignment of a TP/TX interface in MDI-X mode, RJ45 socket

■ 10/100 Mbit/s twisted pair connection PoE (SPIDER II 8TX PoE)

These connections are RJ45 sockets.

10/100 Mbit/s TP PoE ports enable the connection of terminal devices or independent network segments according to the IEEE 802.3 10BASE-T/100BASE-TX and IEEE 802.3af (Power over ETHERNET on data lines) standards.

These ports support:

- ▶ Autonegotiation
- ▶ Autopolarity
- ▶ Autocrossing (if autonegotiation is activated)
- ▶ 100 Mbit/s half-duplex mode, 100 Mbit/s full duplex mode
- ▶ 10 Mbit/s half-duplex mode, 10 Mbit/s full duplex mode
- ▶ Power over ETHERNET (PoE, at the last four ports of the device)

State on delivery: autonegotiation activated.

The socket housing is electrically connected to the front panel.

The PoE voltage is input via the wire pairs transmitting the signal (phantom voltage).

Figure	Pin	Function	PoE
	1	RD+ Receive Data +	V-
	2	RD- Receive Data -	V-
	3	TD+ Transmit Data +	V+
	6	TD- Transmit Data -	V+
	4,5,7,8	Not used	

Table 4: Pin assignment of a TP/TX interface for PoE for the voltage supply to the wire pairs transmitting the signal, RJ45 socket

■ 10/100/1000 Mbit/s twisted pair connection (SPIDER II Giga 5T... EEC)

These connections are RJ45 sockets.

10/100/1000 Mbit/s TP ports enable the connection of terminal devices or independent network segments according to the IEEE 802.3 10BASE-T/100BASE-TX/1000BASE-T standard.

These ports support:

- ▶ Autonegotiation
- ▶ Autopolarity
- ▶ Autocrossing
- ▶ 1000 Mbit/s full duplex
- ▶ 100 Mbit/s half-duplex mode, 100 Mbit/s full duplex mode
- ▶ 10 Mbit/s half-duplex mode, 10 Mbit/s full duplex mode

The pin assignment corresponds to MDI-X.

Figure	Pin	Function
	1	BI_DB +
	2	BI_DB -
	3	BI_DA +
	4	BI_DD +
	5	BI_DD -
	6	BI_DA -
	7	BI_DC +
	8	BI_DC -

Table 5: Pin assignment of a 1000 MBit/s TP interface in MDI-X mode, RJ45 socket

■ 100 Mbit/s F/O connection (SPIDER II 8TX/...FX... EEC)

For the device variants 8TX/1FX EEC, 8TX/1FX-SM EEC, 8TX/2FX EEC and 8TX/2FX-SM EEC, these ports are DSC connectors.

For the device variants 8TX/1FX-ST EEC and 8TX/2FX-ST EEC, these ports are ST connectors.

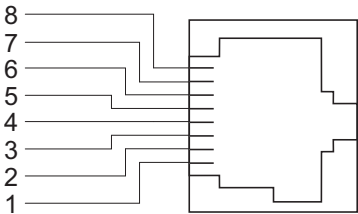
100 MBit/s F/O ports enable the connection of terminal devices or independent network segments in compliance with the IEEE 802.3 100BASE-FX standard.

These ports support:

- ▶ Full duplex mode

Note: Make sure that the SM ports are only connected with SM ports, and MM ports only with MM ports.

■ 1 Gbit/s F/O connection (SPIDER II Giga 5T/2S EEC)

These ports are SFP slots.

1 Gbit/s F/O ports enable the connection of terminal devices or independent network segments according to the IEEE 802.3 1000BASE-SX/1000BASE-LX standard.

These ports support:

- ▶ Autonegotiation
- ▶ Full duplex mode

Note: Make sure that the LH ports are only connected with LH ports, SX ports are only connected with SX ports, and LX ports only with LX ports.

2.2 Display elements

2.2.1 Device state

These LEDs provide information about conditions which affect the operation of the whole device.

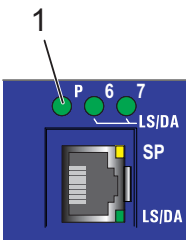

Figure 7: Device status LEDs
1 – Power LED (P)

LED	Display	Color	Activity	Meaning
P	Power	Green	Lights up	Supply voltage is on.
			None	Supply voltage is too low.

2.2.2 Port state

The green and yellow LEDs at the individual port display port-related information.

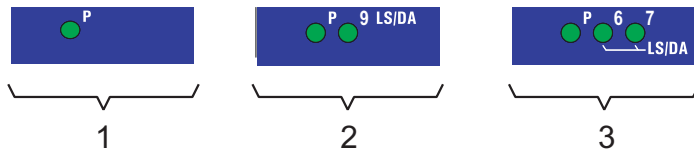

Figure 8: Port status LEDs for F/O ports on the top edge of the front of the device
 1 – No port status LEDs for devices without F/O ports
 2 – One port status LED (LS/DA) for devices with one F/O port
 3 – Two port status LEDs (LS/DA) for devices with two F/O ports

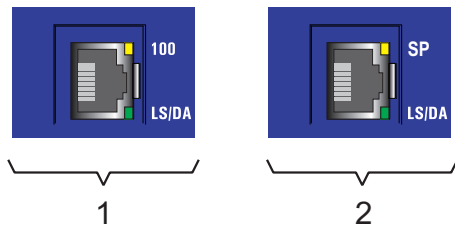

Figure 9: Port status LEDs for TP ports
 1 – Port status LEDs for Fast Ethernet TP ports
 2 – Port status LEDs for Gigabit Ethernet TP ports

LED	Display	Color	Activity	Meaning
LS/DA	Link status data	Green	Lights up	Valid connection
			Flashing	Data traffic
			None	No valid connection
100	Data rate	Yellow	Lights up	100 Mbit/s connection
			None	10 Mbit/s connection
SP	Data rate	Yellow	None	No valid connection
			Flashing 1 time a period	10 Mbit/s connection
			Flashing 2 times a period	100 Mbit/s connection
			Flashing 3 times a period	1000 Mbit/s connection

2.3 Disassembly

2.3.1 Removing the device from the DIN rail

■ SPIDER II without PoE

- To take the device off the DIN rail, insert a screwdriver horizontally under the housing into the locking slide, pull it (without tipping the screwdriver) downwards and lift the device upwards.

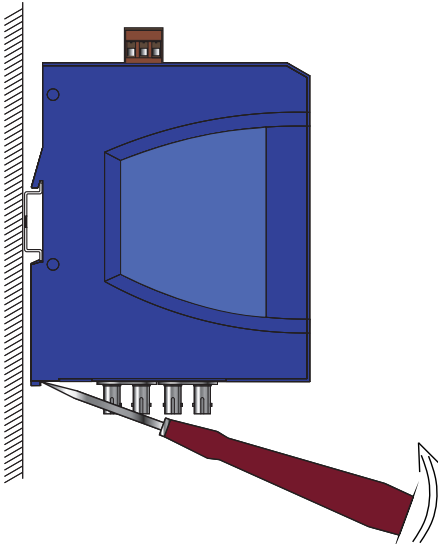

Figure 10: Removal from the DIN rail

■ SPIDER II 8TX PoE

- To remove the device from the DIN rail, press the device downwards and pull it out from under the DIN rail.

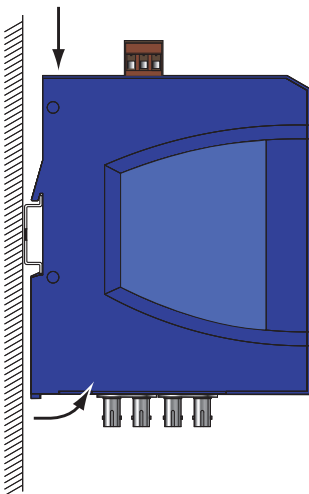

Figure 11: Removal from the DIN rail

2.3.2 Disassembling the SFP modules

- Pull the module out of the socket by means of the opened lock.
- Close the module with the protective cap.



3 Technical data

■ General technical data

Dimensions W x H x D incl. terminal block	SPIDER II 8TX	35 mm x 154 mm x 121 mm
	SPIDER II 8TX EEC	
	SPIDER II 8TX/1FX EEC	
	SPIDER II 8TX/1FX-SM EEC	
	SPIDER II 8TX/2FX EEC	
	SPIDER II 8TX/2FX-SM EEC	
	SPIDER II Giga 5T EEC	
	SPIDER II Giga 5T/2S EEC	
	SPIDER II 8TX/1FX-ST EEC	35 mm x 168 mm x 121 mm
	SPIDER II 8TX/2FX-ST EEC	
Weight	SPIDER II without FX port	246 g
	SPIDER II with one FX port	253 g
	SPIDER II with two FX ports	260 g
	SPIDER II Giga 5T EEC	255 g
	SPIDER II Giga 5T/2S EEC	270 g
	SPIDER II 8TX PoE	560 g
Power supply	Operating voltage SPIDER II without PoE	9.6 to 32.0 V DC Safety extra-low voltage (SELV) Relevant for North America: Nec Class 2 power source max. 5A.
	Operating voltage SPIDER II 8TX PoE	18.0 to 32.0 V DC
	Buffer time	min. 10 ms at 20.4 V DC
	Potential difference between incoming voltage and housing	Potential difference from incoming voltage +24 V DC -32 V DC
Environment	Storage temperature (ambient air)	SPIDER II 8TX Standard: -40 °C to +70 °C SPIDER II 8TX...EEC, SPIDER II Giga... Extended: -40 °C to +85 °C SPIDER II 8TX PoE - 20 °C to + 70 °C
	Humidity	to 95% (non-condensing)
	Air pressure	Up to 2000 m (795 hPa), higher alti- tudes on request
	Operating tempera- ture	SPIDER II 8TX Standard: 0 °C to +60 °C SPIDER II 8TX...EEC, SPIDER II Giga... Extended: -40 °C to +70 °C SPIDER II 8TX PoE -10 °C to +60 °C
Contamination level		2
Protection classes	Laser protection	Class 1 according to EN 60825-1 (2001)
	Protection class	IP 30

■ EMC and immunity

EMC interference immunity		
IEC/EN 61000-4-2	Electrostatic discharge	
	Contact discharge	+/- 4 kV
	Air discharge	+/- 8 kV
IEC/EN 61000-4-3	Electromagnetic field	
	80 - 2,700 MHz	20 V/m
IEC/EN 61000-4-4	Fast transients (burst)	
	DC power line	+/- 2 kV (2.5 kHz)
	Data line	+/- 4 kV (2.5 kHz)
IEC/EN 61000-4-5	Voltage surges	
	DC power line, line / line	+/- 1 kV
	DC power line, line / earth	+/- 2 kV
	Data line, line / earth	+/- 1 kV
IEC/EN 61000-4-6	Line-conducted interference voltages	
	150 kHz - 80 MHz	10 V

EMC emitted interference	
EN 55022	Class A
FCC 47 CFR Part 15	Class A

Stability		
Vibration	IEC 60068-2-6, test Fc	5 Hz to 9 Hz with 3.5 mm amplitude; 1g at 9 Hz to 150 Hz; 1.5 g at 200 Hz to 250 Hz
	IEC 60068-2-6, resonance search / resonance dwell, test Fc	2 Hz to 13.2 Hz with 1 mm amplitude; 0.7 g at 13.2 Hz to 100 Hz
Shock	IEC 60068-2-27 test Ea	15 g at 11 ms

■ Network range

TP port	
Length of a twisted pair segment	max. 100 m / 300 ft (cat5e cable with 1000BASE-T)

Table 6: TP port 10BASE-T / 100BASE-TX / 1000BASE-T

Product code	F/O type	Wave length	Fiber	System at- tenuation	Expansion	Fiber data
...FX EEC	MM	1300 nm	50/125 µm	0-8 dB	0-5 km	1.0 dB/km; 800 MHz*km
...FX-ST EEC						
...FX EEC	MM	1300 nm	62.5/125 µm	0-11 dB	0-4 km	1.0 dB/km; 500 MHz*km
...FX-ST EEC						
...FX-SM EEC	SM	1300 nm	9/125 µm	0-16 dB	0-30 km	0.4 dB/km; 3.5 ps/(nm*km)

Table 7: F/O port 100BASE-FX

Product code M-SFP- ...	F/O type	Wave length	Fiber	System at- tenuation	Expansion	Fiber data
-SX/LC...	MM	850 nm	50/125 µm	0-7.5 dB	0-550 m	3.0 dB/km, 400 MHz*km
-LX/LC...	MM	1310 nm ^a	50/125 µm	0-11 dB	0-550 m	1.0 dB/km, 800 MHz*km
-SX/LC...	MM	850 nm	62.5/125 µm	0-7.5 dB	0-275 m	3.2 dB/km, 200 MHz*km
-LX/LC...	MM	1310 nm ^a	62.5/125 µm	0-11 dB	0-550 m	1.0 dB/km, 500 MHz*km
-LX/LC...	SM	1310 nm	9/125 µm	0-11 dB	0-20 km	0.4 dB/km; 3.5 ps/(nm*km)
-LH/LC...	LH	1550 nm	9/125 µm	6-22 dB	24-72 km	0.25 dB/km; 19 ps/(nm*km)

Table 8: Fiber port 1000BASE-FX (SFP fiber optic Gigabit ETHERNET Transceiver)

- a. With F/O adapter compliant with IEEE 802.3-2002 clause 38 (single-mode fiber offset-launch mode conditioning patch cord)

MM = Multimode, SM = Singlemode, LH = Singlemode Longhaul

■ Power consumption/power output at 24 V DC

Device name	Max. power consumption	Power output
SPIDER II 8TX	4.1 W	14.0 Btu (IT)/h
SPIDER II 8TX EEC	5.8 W	19.8 Btu (IT)/h
SPIDER II 8TX/1FX EEC	6.3 W	21.5 Btu (IT)/h
SPIDER II 8TX/2FX EEC	8.4 W	28.7 Btu (IT)/h
SPIDER II 8TX/1FX-SM EEC	7.0 W	23.9 Btu (IT)/h
SPIDER II 8TX/1FX-ST EEC	7.0 W	23.9 Btu (IT)/h
SPIDER II 8TX/2FX-SM EEC	8.4 W	28.7 Btu (IT)/h
SPIDER II 8TX/2FX-ST EEC	8.4 W	28.7 Btu (IT)/h
SPIDER II Giga 5T EEC	3.6 W	12.1 Btu (IT)/h
SPIDER II Giga 5T/2S EEC	6.6 W	21.6 Btu (IT)/h
SPIDER II 8TX PoE non-PD (powered device)	4.6 W	15.7 Btu (IT)/h
SPIDER II 8TX PoE 4 x Class0-PD (powered device)	74.9 W	255.5 Btu (IT)/h

■ Scope of delivery

Device	Scope of delivery
SPIDER II...	Device
	Terminal block for the supply voltage
	Installation user manual

■ Order numbers

Device	Order number
Rail Switch SPIDER II 8 TX	943 957-001
Rail Switch SPIDER II 8 TX EEC	943 958-001
Rail Switch SPIDER II 8 TX/1FX EEC	943 958-111

Device	Order number
Rail Switch SPIDER II 8 TX/2FX EEC	943 958-211
Rail Switch SPIDER II 8 TX/1FX-SM EEC	943 958-131
Rail Switch SPIDER II 8 TX/2FX-SM EEC	943 958-231
Rail Switch SPIDER II 8 TX/1FX-ST EEC	943 958-121
Rail Switch SPIDER II 8 TX/2FX-ST EEC	943 958-221
Rail Switch SPIDER II Giga 5T EEC	943 962-002
Rail Switch SPIDER II Giga 5T/2S EEC	943 963-002
Rail Switch SPIDER II 8TX PoE	942 008-001

■ Accessories

Name	Order number
Pocket Guide	280 710-851
Rail Power Supply RPS 30	943 662-003
Rail Power Supply RPS 80 EEC	943 662-080
Rail Power Supply RPS 120 EEC	943 662-120
Gigabit ETHERNET SFP Transceiver	
M - SFP - SX / LC EEC	943 896-001
M - SFP - LX / LC EEC	943 897-001
M - SFP - LH / LC EEC	943 898-001

■ Underlying norms and standards

Norm	
cUL 508:1998	Safety for Industrial Control Equipment
EN 55022:2006	IT equipment – radio interference characteristics
EN 61000-6-2:2005	Generic norm – immunity in industrial environments
EN 61131-2:2003	Programmable logic controllers
IEC/EN 60950-1:2006	Safety for the installation of IT equipment
FCC 47 CFR Part 15:2006	Code of Federal Regulations

Table 9: List of norms and standards. Certified devices are marked with a certification indicator. From the imprint on the device label you will see the current certification status of your device.

■ Certifications

Standard	SPIDER II...
UL508 (E175531)	pending

Table 10: Certifications - for the current status, visit www.hirschmann.com

Further support

■ Technical questions and training courses

In the event of technical queries, please contact your local Hirschmann distributor or Hirschmann office.

You can find the addresses of our distributors on the Internet:

www.hirschmann-ac.com.

Our support line is also at your disposal:

- ▶ Tel. +49 1805 14-1538
- ▶ Fax +49 7127 14-1551

Answers to Frequently Asked Questions can be found on the Hirschmann internet site (www.hirschmann-ac.com) at the end of the product sites in the FAQ category.

The current training courses to technology and products can be found under <http://www.hicomcenter.com>.

■ Hirschmann Competence Center

In the long term, excellent products alone do not guarantee a successful customer relationship. Only comprehensive service makes a difference worldwide. In the current global competition scenario, the Hirschmann Competence Center is ahead of its competitors on three counts with its complete range of innovative services:

- ▶ Consulting incorporates comprehensive technical advice, from system evaluation through network planning to project planning.
- ▶ Training offers you an introduction to the basics, product briefing and user training with certification.
- ▶ Support ranges from the first installation through the standby service to maintenance concepts.

With the Hirschmann Competence Center, you have decided against making any compromises. Our client-customized package leaves you free to choose the service components you want to use.

Internet:

<http://www.hicomcenter.com>.



HIRSCHMANN

A **BELDEN** BRAND

X-ON Electronics

Largest Supplier of Electrical and Electronic Components

Click to view similar products for [hirschmann](#) manufacturer:

Other Similar products are found below :

[931298001 GSP 211 PG11](#) [934828001 BRSCIS 4D/9](#) [930011200 MAB 6](#) [932326100 CA 6 GS](#) [G 30 KW 3 M](#) [831530400 CA 00 SD 1](#)
[934077105](#) [934066788](#) [934061103](#) [934059104](#) [930046100](#) [975090703](#) [943301-001](#) [934061704](#) [STAK2](#) [PRUEF1SW](#) [SPIDER-PL-20-](#)
[05T1999999TZ9HHHH](#) [BAT867-RUSW99AU999AT199L999ZHX](#) [930136106](#) [930317804](#) [934066105](#) [934076103](#) [934086104](#) [934086188](#)
[973929000](#) [934157101](#) [934077106](#) [934064104](#) [932794001](#) [973601101](#) [GECKO 4TX](#) [972309101](#) [934100707](#) [975455709](#) [975455701](#)
[973528101](#) [931297006](#) [MESAP 43650](#) [932140100](#) [STAK 3 N SCHWARZ](#) [932507005](#) [XZC 0704](#) [975694707](#) [MLSWG100/2.5RT](#) [BAT867-](#)
[RUSW99CU999AT199L999ZHX](#) [934081100](#) [934089101](#) [934090100](#) [973929001](#) [975017701](#) [975106101](#) [934157100](#)