



东莞市皇捷通讯科技有限公司

DONGGUAD HUANG JIE COMMUNI CAT ION TECHNOLOGY CO.,LTD.

3N0301LG-007

2.4/5GHz ISM Flexible Polymer

Key Features

2.4/5 GHz ISM
2400-2500 MHz
5150-5850 MHz
Embedded Antenna
Wifi Antenna
High Performance
Ground Plane Independent
Self-Adhesive
Dimensions 40.4 x 7.4mm
ustomizable Cable and Connecto

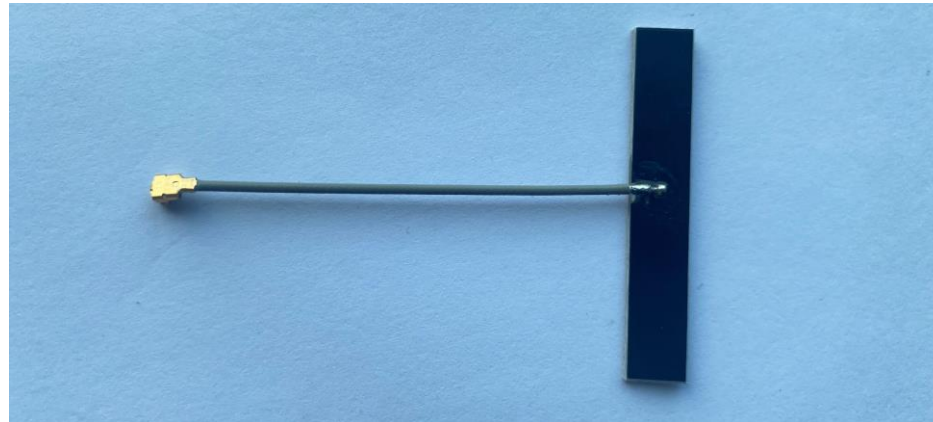

Description

3N0301LG-007 antenna is flexible high efficiency embedded solution covering 2.4/5 GHz. Antenna can be easily mounted in most devices due to self-adhesive layer and small size. 3N0301LG-007 is omnidirectional, ground plane independent antenna. Cable and connector is upon request.

东莞市皇捷通讯科技有限公司
地址:广东省东莞市寮步镇泉塘大岷地工业区
网址:www.iphone-line.com
电话:0769-83328111 FAX:83327688





Antenna and electrical specifications

Parameters	2.4/5GHz ISM Flexible Polymer
Standards	双频
Band (MHz)	2.4/5GHz
Frequency (MHz)	2400-2500 MHz, 5150-5850 MHz
Return Loss (dB)	-15.6
VSWR	<2.5
Efficiency (%)	40-60
Peak Gain (dBi)	2
Impedance (Ohm)	50
Polarisation	Linear
Radiation Pattern	Omni-Directional
Max. Input Power (W)	25
Connector Type	Most RF Connectors (U.FL Standard)
Cable Length	Any Cable Length (50mm Standard)
Cable Type	Other Cables Available (1.13mm Standard)

Antenna Measurement Conditions:

Mounted 40x10x0.3 Cm ABS Plastic Plate

Measured in Certified CTIA 3DAnechoic Chamber



Mechanical and environmental specifications

Specifications	3N0301LG-007
Mounting Type	Self-Adhesive
Dimensions (mm)	40.4 x 7.4mm
Adhesive Type	3M
Material	Flexible Polymer
Operating Temperature (C)	-40 to +85
Storage Temperature (C)	-40 to +85
Substance Compliance	RoHS

REVISION	DESCRIPTION	DATE	DRAFTER
A0	FIRST RELEASE	18.06.19	DENGJUN. TAN

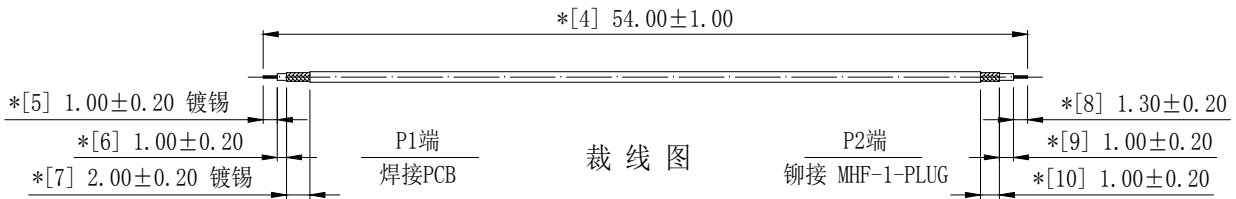
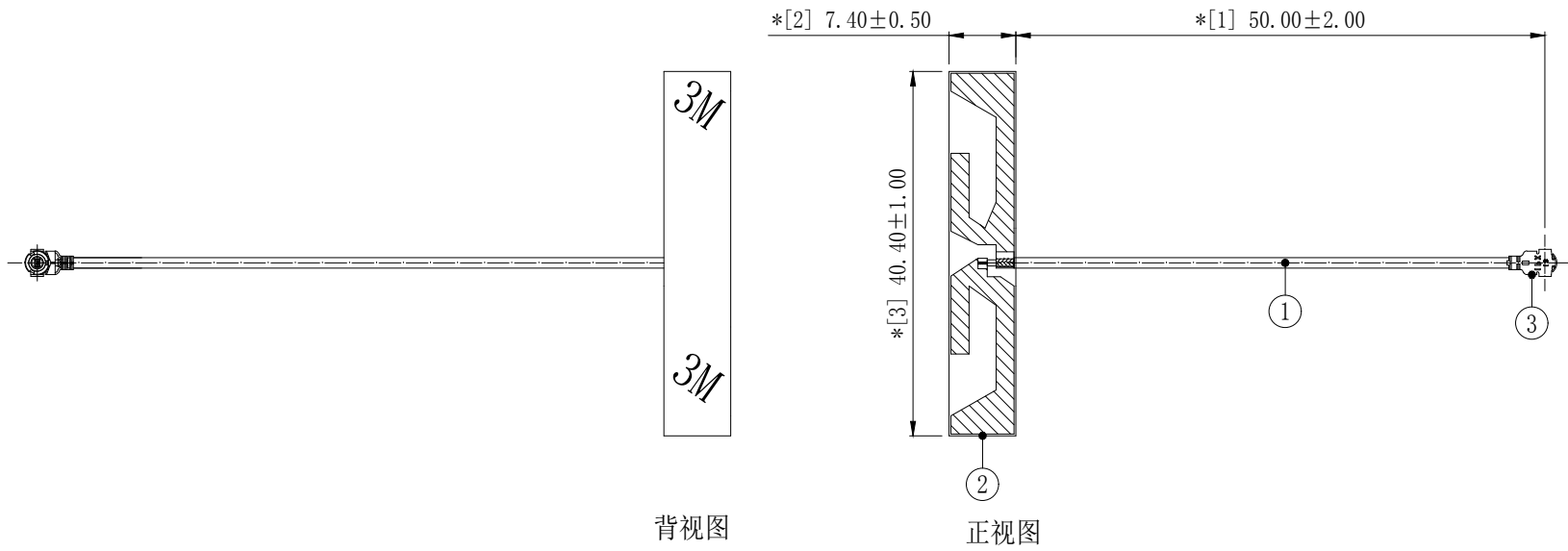

技术要求:

- 方向要求: 端子口方向指向PCB背面, 如图所示。
- 电气特性: 特性阻抗: 50Ω; 频率范围: 2.40GHz~2.50GHz & 5.15GHz~5.85GHz; 驻波比: 最大2.50;
检验方法: 单测天线, 使用网络分析仪100%比对Gold sample波形测试。
- 尺寸检验: [*]为FAI检测项目; *为重点检测项目; ■为CPK管制项目。
- 外观检验: 电缆裁切须平整, 镀锡须光亮, 导体不得有多余股数伸出与散乱;
PCB不得有划痕、刮伤、露铜等不良, 焊接须饱满, 不得有假焊、虚焊、毛刺;
电缆外被不得有破损、折皱及异色等不良。
检验方法: 目视全检。
- 包装规范: 50PCS/扎, 2扎/包, 即100PCS/包。
- 环保要求: 产品及其使用之物料皆需要符合RoHS要求。

3	2LM10P113210	MHF-1-PLUG FOR OD1.13 CABLE	1	---
2	2YPO24	L40.40*W7.40*T0.80mm, 焊锡点区域镀锡	1	含3M 背胶
1	2C5M11312LG1	微细同轴电缆, OD1.13, 双锡线, 浅灰色	1	依裁线图裁线
No.	PART NUMBER	PART NAME & DESCRIPTION	Q' TY	REMARKS

GENERAL TOLERANCE:
 LINEAR:
 X ±0.20
 X.X ±0.15
 X.XX ±0.05
 X.XXX ±0.01
 ANGLE:
 X° ±4.00°
 X.X° ±3.00°
 X.XX° ±2.00°
 X.XXX° ±1.00°

HJ-Tech 东莞市皇捷通讯科技有限公司

FILE NAME: 产品图
 TITLE: 内置天线, OD1.13, 双锡线, 浅灰色;
 P1端焊接PCB; P2端打一代端子; 裁线长L=54mm
 A7550D113001L

ENG/DATE: DENGJUN. TAN/18.06.19
 CHE/DATE: .
 APP/DATE: .

P/N: 3N0301LG-007

UNIT: mm
 SCALE: 1:1
 REVISION: A0
 SHEET: 1/1

COMPLIANCE WITH THE REQUIREMENT: ■RoHS; □HF; □SONY SS-00259; □OTHERS
 *NO USING ESTRICED AND BANNED SUBSTANCE

H372

实物照片

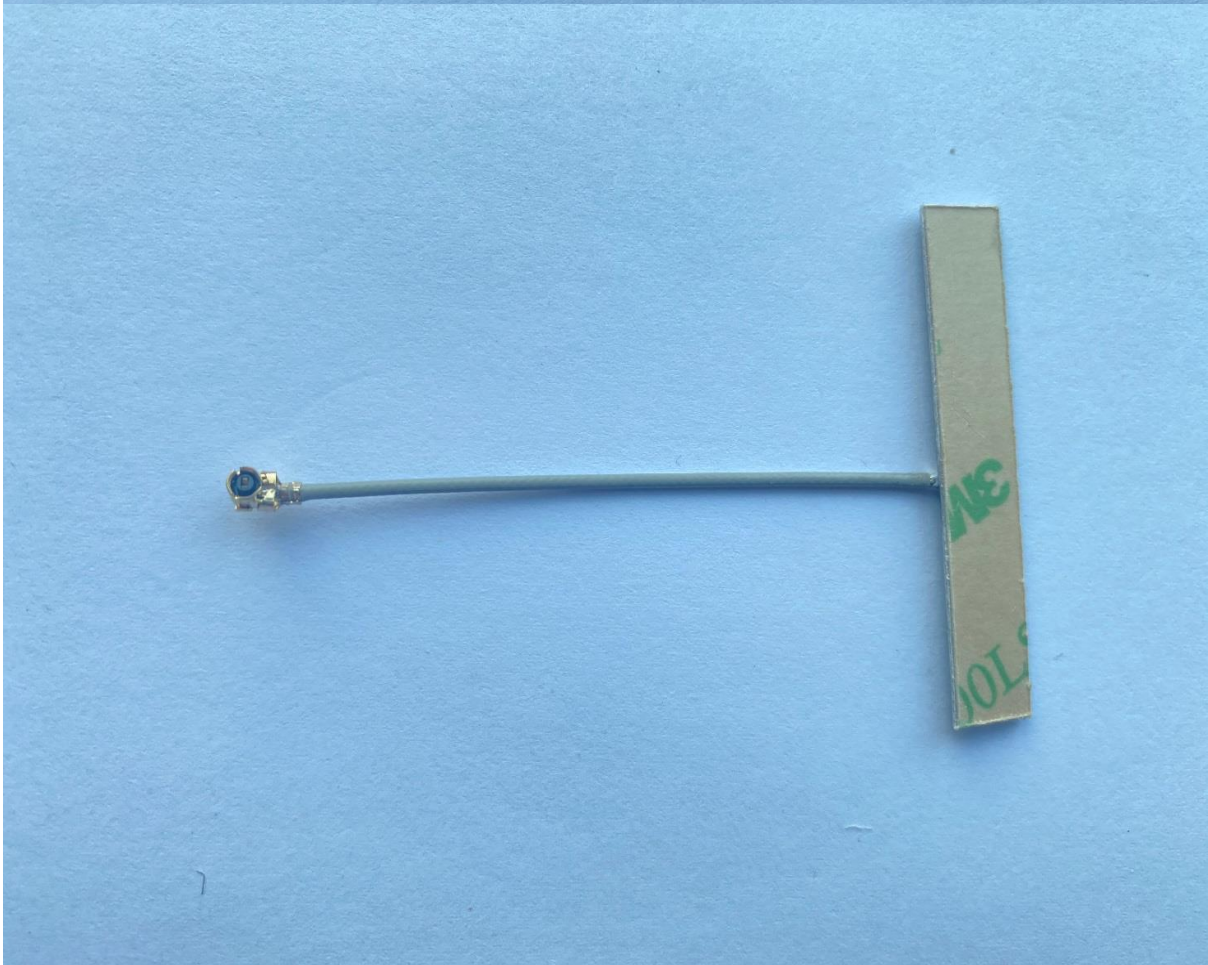
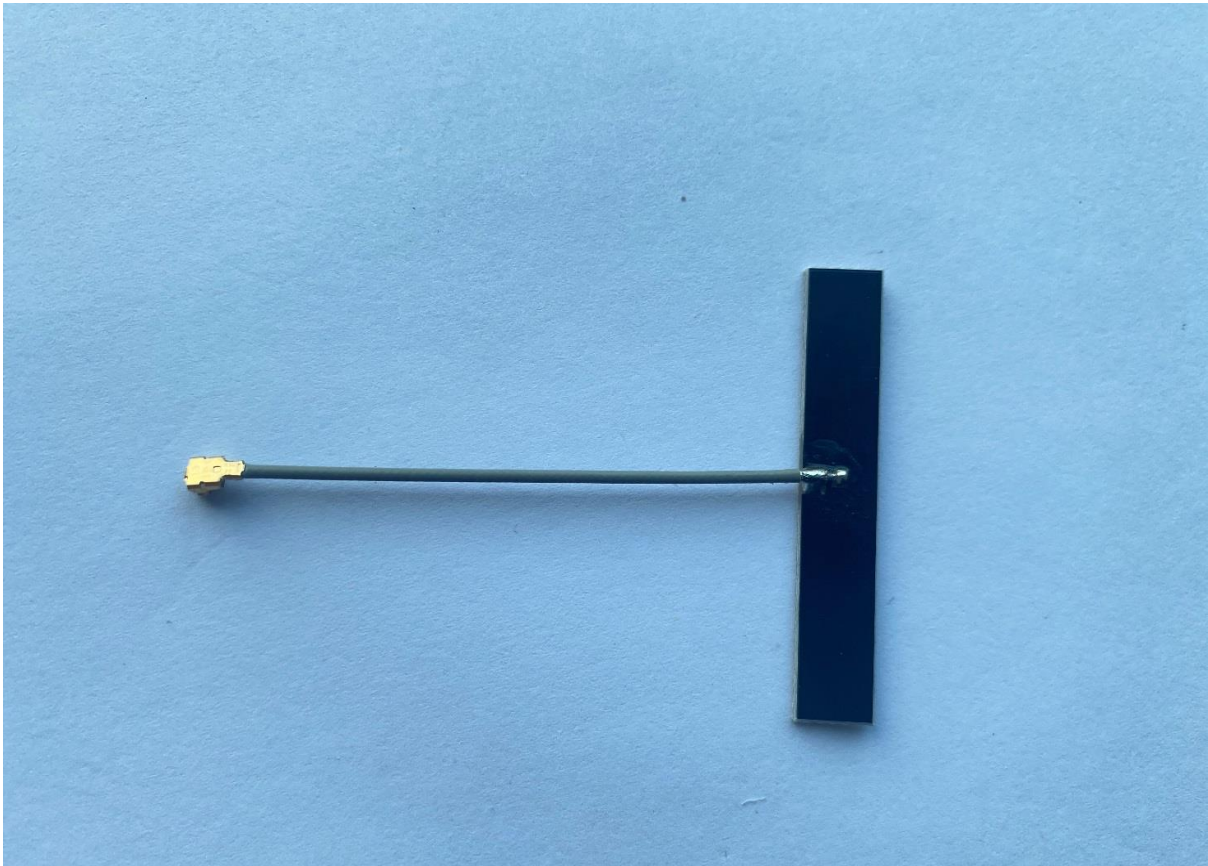

东莞市皇捷通讯科技有限公司

天线电气特性测试报告

Antenna Electrical Characteristic Test Report

编号:HJ-QR-Q-13/A0

产品料号 Part Number:	3N0301LG-007	测试项目 Item	规格 Spec	结果判定 Judge
产品名称 Part Name:	内置双频天线	VSWR 驻波比	≤2.0	pass
测试设备 Test Equipment	网络分析仪/暗室	Characteristic impedance 特性阻抗	50Ω	pass
数量 Quantity	5pcs	Gain 增益	2dBi	pass
测试日期 Test Date	2021/6/16			

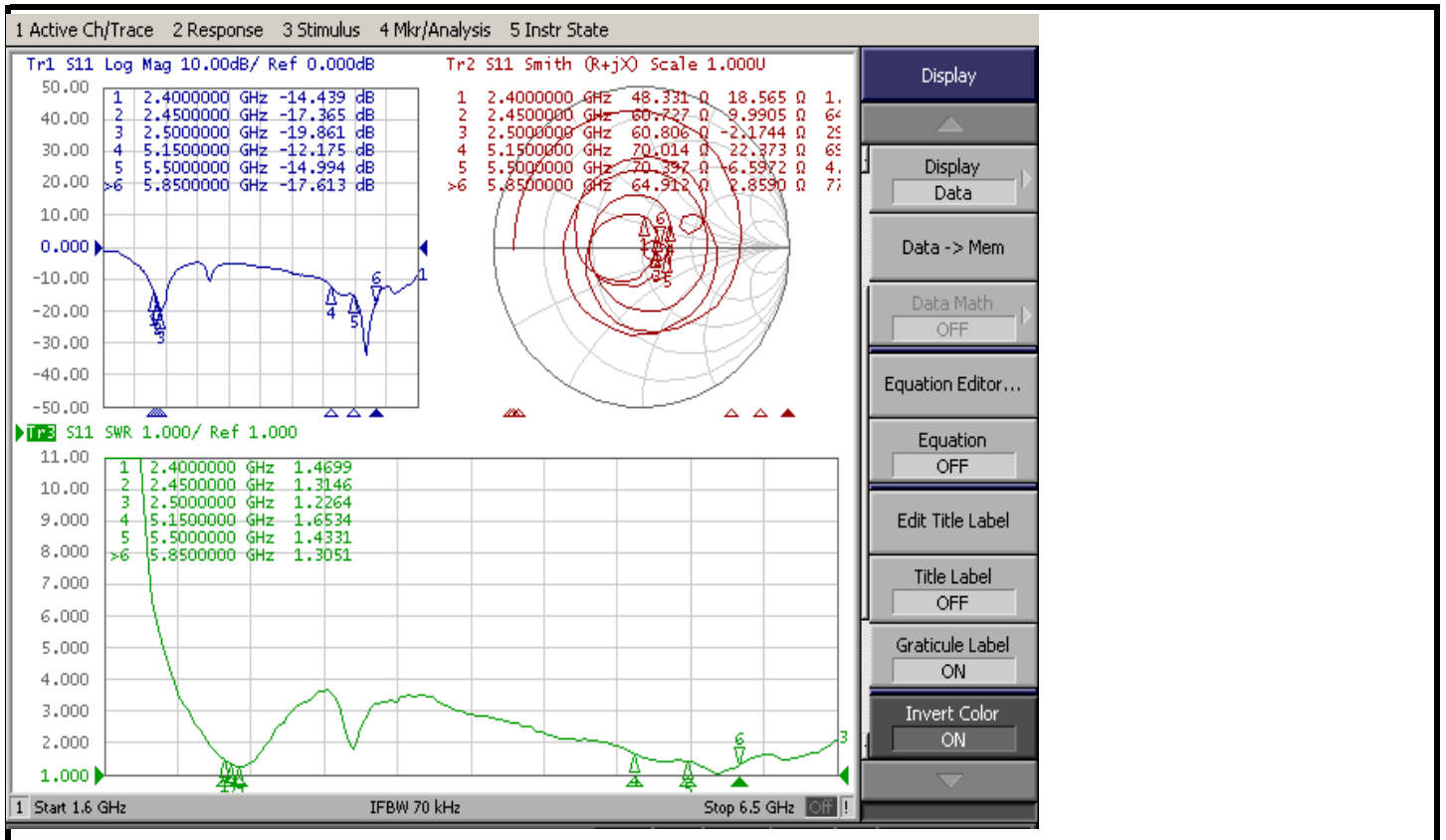

FETUKEJI

Frequency ID	1	2	3	4	5	6	7	8	9	10	11
Frequency (MHz)	2400.0	2410.0	2420.0	2430.0	2440.0	2450.0	2460.0	2470.0	2480.0	2490.0	2500.0
Point Values											
Ant. Port Input Pwr. (dBm)	0.00	0.00	0.00	0.00	0.00	0.00	0.00	0.00	0.00	0.00	0.00
Tot. Rad. Pwr. (dBm)	-2.39	-2.31	-2.19	-1.95	-1.74	-1.72	-1.61	-1.41	-1.46	-1.41	-1.38
Peak EIRP (dBm)	1.69	1.75	1.88	2.24	2.53	2.56	2.73	3.04	3.10	3.22	3.27
Directivity (dBi)	4.07	4.06	4.07	4.19	4.27	4.28	4.34	4.45	4.56	4.64	4.64
Efficiency (dB)	-2.39	-2.31	-2.19	-1.95	-1.74	-1.72	-1.61	-1.41	-1.46	-1.41	-1.38
Efficiency (%)	57.70	58.70	60.40	63.80	67.10	67.30	69.00	72.20	71.40	72.20	72.80
Gain (dBi)	1.69	1.75	1.88	2.24	2.53	2.56	2.73	3.04	3.10	3.22	3.27
NHPRP $\pm\pi/4$ (dBm)	-4.11	-4.03	-3.93	-3.70	-3.49	-3.49	-3.36	-3.16	-3.19	-3.12	-3.05
NHPRP $\pm\pi/6$ (dBm)	-5.89	-5.79	-5.69	-5.46	-5.25	-5.24	-5.10	-4.89	-4.91	-4.83	-4.75
NHPRP $\pm\pi/8$ (dBm)	-7.31	-7.20	-7.10	-6.88	-6.66	-6.64	-6.49	-6.26	-6.27	-6.17	-6.10
Upper Hem. PRP (dBm)	-5.42	-5.34	-5.20	-4.94	-4.72	-4.73	-4.66	-4.51	-4.60	-4.57	-4.54
Lower Hem. PRP (dBm)	-5.37	-5.31	-5.21	-4.99	-4.77	-4.73	-4.58	-4.34	-4.35	-4.29	-4.24
Upper Hem. PRP (%)	28.70	29.23	30.22	32.07	33.70	33.64	34.21	35.41	34.71	34.94	35.19
Lower Hem. PRP (%)	29.04	29.46	30.15	31.73	33.36	33.64	34.84	36.82	36.71	37.26	37.63

FETUKEJI

Frequency ID	12	13	14	15	16	17	18	19	20	21	22	23	24	25	26
Frequency (MHz)	5150.0	5200.0	5250.0	5300.0	5350.0	5400.0	5450.0	5500.0	5550.0	5600.0	5650.0	5700.0	5750.0	5800.0	5850.0
Point Values															
Ant. Port Input Pwr. (dBm)	0.00	0.00	0.00	0.00	0.00	0.00	0.00	0.00	0.00	0.00	0.00	0.00	0.00	0.00	0.00
Tot. Rad. Pwr. (dBm)	-3.92	-2.82	-2.66	-3.35	-2.81	-1.86	-2.64	-2.31	-2.60	-3.22	-3.66	-3.45	-3.19	-3.42	-3.71
Peak EIRP (dBm)	0.54	1.66	1.62	1.05	1.69	4.23	4.03	4.21	2.73	0.86	0.43	0.79	0.96	0.79	1.02
Directivity (dBi)	4.46	4.47	4.28	4.41	4.50	6.09	6.67	6.51	5.33	4.08	4.10	4.24	4.14	4.21	4.74
Efficiency (dB)	-3.92	-2.82	-2.66	-3.35	-2.81	-1.86	-2.64	-2.31	-2.60	-3.22	-3.66	-3.45	-3.19	-3.42	-3.71
Efficiency (%)	40.50	52.30	54.20	46.20	52.40	65.20	54.40	58.80	54.90	47.60	43.00	45.20	48.00	45.50	42.60
Gain (dBi)	0.54	1.66	1.62	1.05	1.69	4.23	4.03	4.21	2.73	0.86	0.43	0.79	0.96	0.79	1.02
NHPRP $\pm\pi/4$ (dBm)	-5.95	-4.83	-4.65	-5.30	-4.76	-3.81	-4.66	-4.41	-4.71	-5.31	-5.75	-5.51	-5.25	-5.50	-5.80
NHPRP $\pm\pi/6$ (dBm)	-7.93	-6.78	-6.60	-7.23	-6.71	-5.74	-6.57	-6.31	-6.59	-7.17	-7.61	-7.37	-7.09	-7.33	-7.62
NHPRP $\pm\pi/8$ (dBm)	-9.32	-8.13	-7.99	-8.59	-8.05	-7.07	-7.88	-7.66	-7.92	-8.53	-8.94	-8.71	-8.44	-8.70	-9.00
Upper Hem. PRP (dBm)	-6.98	-5.89	-5.71	-6.45	-5.90	-4.96	-5.67	-5.27	-5.55	-6.17	-6.61	-6.43	-6.21	-6.48	-6.83
Lower Hem. PRP (dBm)	-6.89	-5.77	-5.63	-6.28	-5.74	-4.78	-5.64	-5.36	-5.68	-6.30	-6.74	-6.48	-6.18	-6.38	-6.61
Upper Hem. PRP (%)	20.05	25.79	26.86	22.66	25.70	31.88	27.12	29.71	27.89	24.18	21.85	22.75	23.92	22.50	20.73
Lower Hem. PRP (%)	20.46	26.50	27.37	23.54	26.69	33.29	27.31	29.08	27.02	23.43	21.17	22.47	24.09	23.00	21.82

2400.00MHz@T45P45

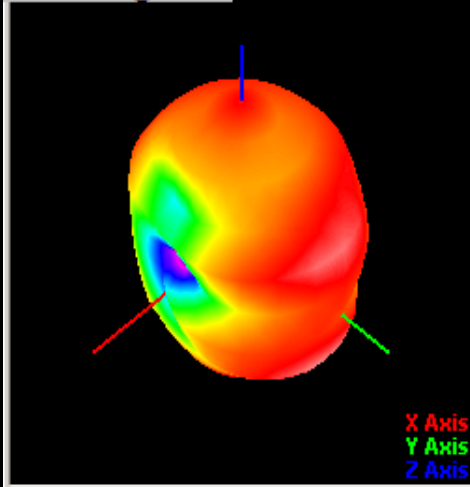

5150.00MHz@T45P45

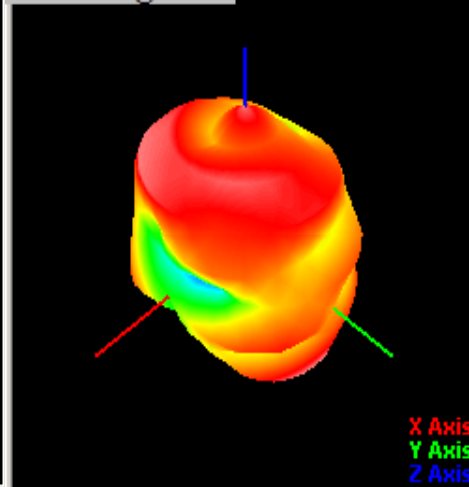

5850.00MHz@T45P45

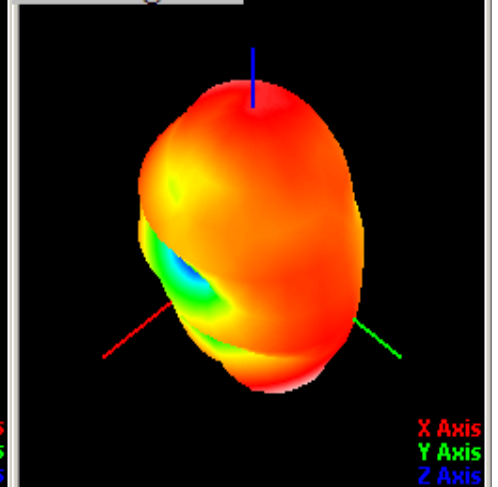

审核人 Checked by	蒋能光	测试人 Tested by	楚欢
-------------------	-----	------------------	----

X-ON Electronics

Largest Supplier of Electrical and Electronic Components

Click to view similar products for [Antennas](#) category:

Click to view products by [HJ Technology](#) manufacturer:

Other Similar products are found below :

[GAN30084EU](#) [930-033-R](#) [EXE902SM](#) [APAMPG-117](#) [MAF94383](#) [W6102B0100](#) [SPDA17RP918](#) [A09-F5NF-M](#) [RGFRA1903041A1T](#) [108-00016-050](#) [W3921B0100](#) [SIMNA-868](#) [SIMNA-915](#) [SIMNA-433](#) [W1049B090](#) [TRABT1560](#) [A75-001](#) [W3118A](#) [WTL2449CQ1-FRSMM](#) [CPL9C](#) [0600-00060](#) [GD5W-28P-NF](#) [MA9-7N](#) [GD53-25](#) [C37](#) [MAF94051](#) [FRX380](#) [MA9-5N](#) [B1322NR](#) [QWFTB120](#) [MAF94271](#) [MAF94300](#) [GPSMB301](#) [FG4403](#) [PSQ24495-91RSM](#) [MIKROE-2393](#) [DA5-32RADOME](#) [5200227](#) [GPSCPMM00](#) [W1049B030](#) [SPDA17RP918](#) [GPSCP00](#) [AN 303](#) [ANTDOM-05-01-WPM](#) [EXW30BNX](#) [OSCAR1A/5M/SMAM/S/S/31](#) [ALPHA4A/1M/SMAM/S/S/26](#) [OSCAR1A/10M/SMAM/S/S/31](#) [OSCAR40/5M/LL/SMAM/S/S/33](#) [OSCAR40/10M/LL/SMAM/S/S/33](#)