



东莞市皇捷通讯科技有限公司

DONGGUAD HUANG JIE COMMUNI CAT ION TECHNOLOGY CO.,LTD.

3N0401BK-015

4GHz ISM Flexible Polymer

Key Features

4 GHz ISM

824-960 MHz

1710-2170 MHz

2300-2690 MHz

Embedded Antenna

Wifi Antenna

High Performance

Ground Plane Independent

Self-Adhesive

Dimensions 59.5 x 15.6mm

ustomizable Cable and Connecto



Description

3N0401BK-015 antenna is flexible high efficiency embedded solution covering 4 GHz. Antenna can be easily mounted in most devices due to self-adhesive layer and small size. 3N0401BK-015 is omnidirectional, ground plane independent antenna. Cable and connector is upon request.

东莞市皇捷通讯科技有限公司

地址:广东省东莞市寮步镇泉塘大蚬地工业区

网址:www.iphone-line.com

电话:0769-83328111

FAX:83327688





Antenna and electrical specifications

Parameters	4GHz ISM Flexible Polymer
Standards	WiFi
Band (MHz)	2.4GHz
Frequency (MHz)	824-960 MHz,1710-2170 MHz,2300-2690 MHz
Return Loss (dB)	-15.6
VSWR	<2.0
Efficiency (%)	40-60
Peak Gain (dBi)	3
Impedance (Ohm)	50
Polarisation	Linear
Radiation Pattern	Omni-Directional
Max. Input Power (W)	25
Connector Type	Most RF Connectors (U.FL Standard)
Cable Length	Any Cable Length (110mm Standard)
Cable Type	Other Cables Available (1.13mm Standard)

Antenna Measurement Conditions:

Mounted 40x10x0.3 Cm ABS Plastic Plate

Measured in Certified CTIA 3DAnechoic Chamber



Mechanical and environmental specifications

Specifications	3N0401BK-015
Mounting Type	Self-Adhesive
Dimensions (mm)	59.5 x 15.6mm
Adhesive Type	3M
Material	Flexible Polymer
Operating Temperature (C)	-40 to +85
Storage Temperature (C)	-40 to +85
Substance Compliance	RoHS

REVISION	DESCRIPTION	DATE	DRAFTER
A0	FIRST RELEASE	20.05.18	Mark

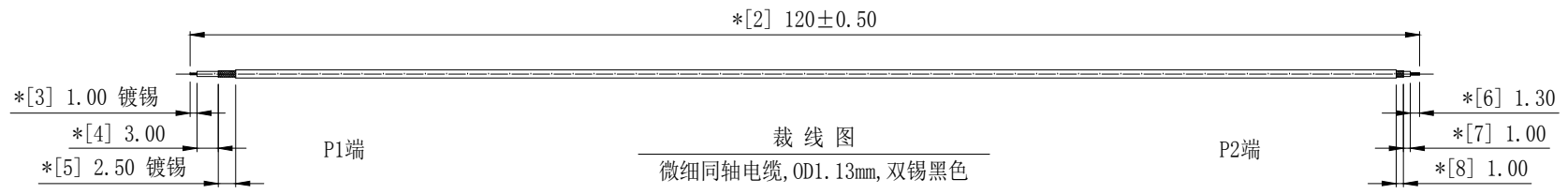
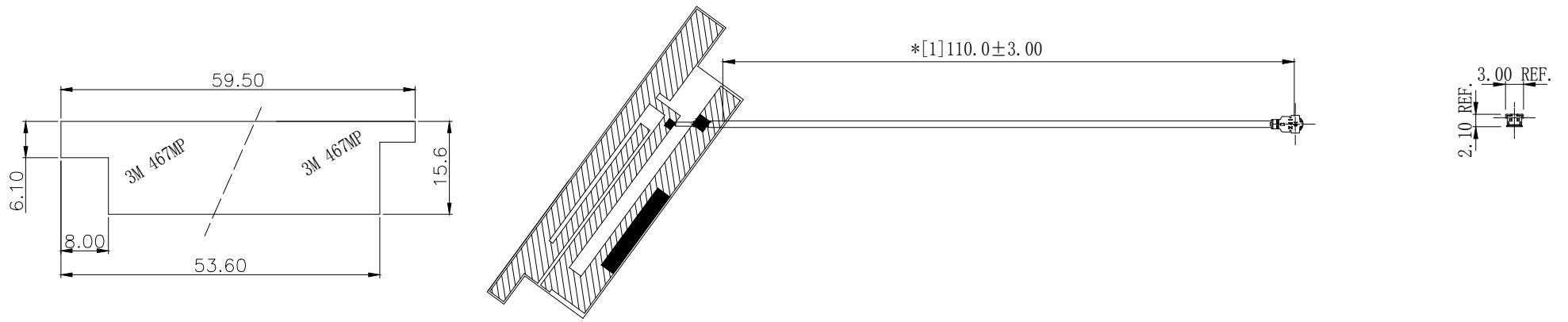

- 技术要求:
- 1 方向要求: 如图所示。
 - 2 电气特性: 特性阻抗:50Ω; 适用频率范围:824MHZ-960MHZ:1710MHZ-2170MHZ:2300MHZ-2690MHZ。
检验方法: 使用矢量网络分析仪100% Gold sample波形比对测试。
 - 3 拔出力测试: 最小1.30kgf。
测试方法: 沿电缆中心轴, 以25±3毫米/分钟的速度, 垂直将1.30kg砝码提高桌面即为合格, 反之不合格。
 - 4 尺寸检验: [*]为FAI检测项目; *为重点检测项目; ■为CPK管制项目。
 - 5 外观检验: 目视全检。产品表面不得有刮伤、破损和脏污; 镀层色泽光亮均匀, 不得有氧化。
 - 6 包装规范: 20PCS/扎, 5扎/包, 即100PCS/包。
 - 7 环保要求: 产品及其使用之物料皆需要符合RoHS要求。

No.	PART NUMBER	PART NAME & DESCRIPTION	Q' TY	REMARKS
3	2YF034	FPC, L59.5*W15.6, FPC, 背面黑油防焊漆	1	---
2	2LM10P113210	MHF-1-PLUG FOR OD1.13 CABLE	1	---
1	2C5M11312BK1	微细同轴电缆, OD1.13, 双锡线, 黑色	1	依裁线图裁线

GENERAL TOLERANCE: LINEAR: X ±0.20 X.X ±0.15 X.XX ±0.05 X.XXX ±0.01 ANGLE: X° ±4.00° X.X° ±3.00° X.XX° ±2.00° X.XXX° ±1.00°		HJ-Tech 东莞市皇捷通讯科技有限公司	
FILE NAME: 产品图	TITLE: 内置天线, OD1.13双锡黑色线; P1端焊接FPC天线, P2端铆接MHF-1-PLUG, 裁线长L=120mm		
ENG/DATE: Mark/20.05.18	P/N: 3N0401BK-015		
CHE/DATE:	UNIT: mm	SCALE: 1:1	REVISION: AO
APP/DATE:	SHEET: 1/1		

COMPLIANCE WITH THE REQUIREMENT: ■RoHS; □HF; □SONY SS-00259; □OTHERS
*NO USING ESTRICED AND BANNED SUBSTANCE

H527

实物照片

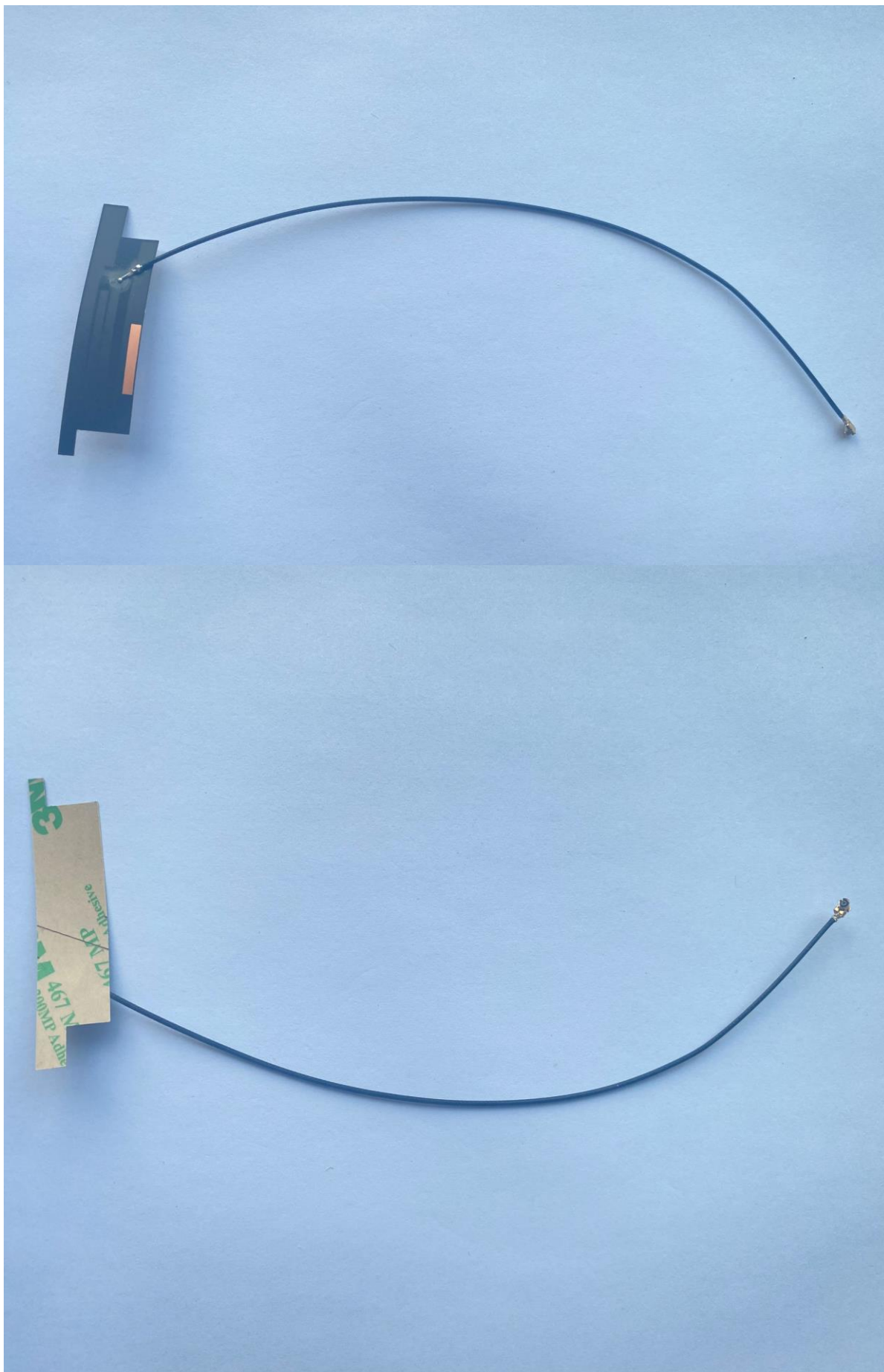

天线电气特性测试报告

Antenna Electrical Characteristic Test Report

编号:HJ-QR-Q-13/A0

产品料号 Part Number:	3N0401BK-015	测试项目 Item	规格 Spec	结果判定 Judge
产品名称 Part Name:	内置4G天线	VSWR 驻波比	≤2.0	pass
测试设备 Test Equipment	Network analyzer网络分析仪	Characteristic impedance 特性阻抗	50Ω	pass
数量 Quantity	5pcs	Gain 增益	2dBi	pass
测试日期 Test Date	2021/6/16			

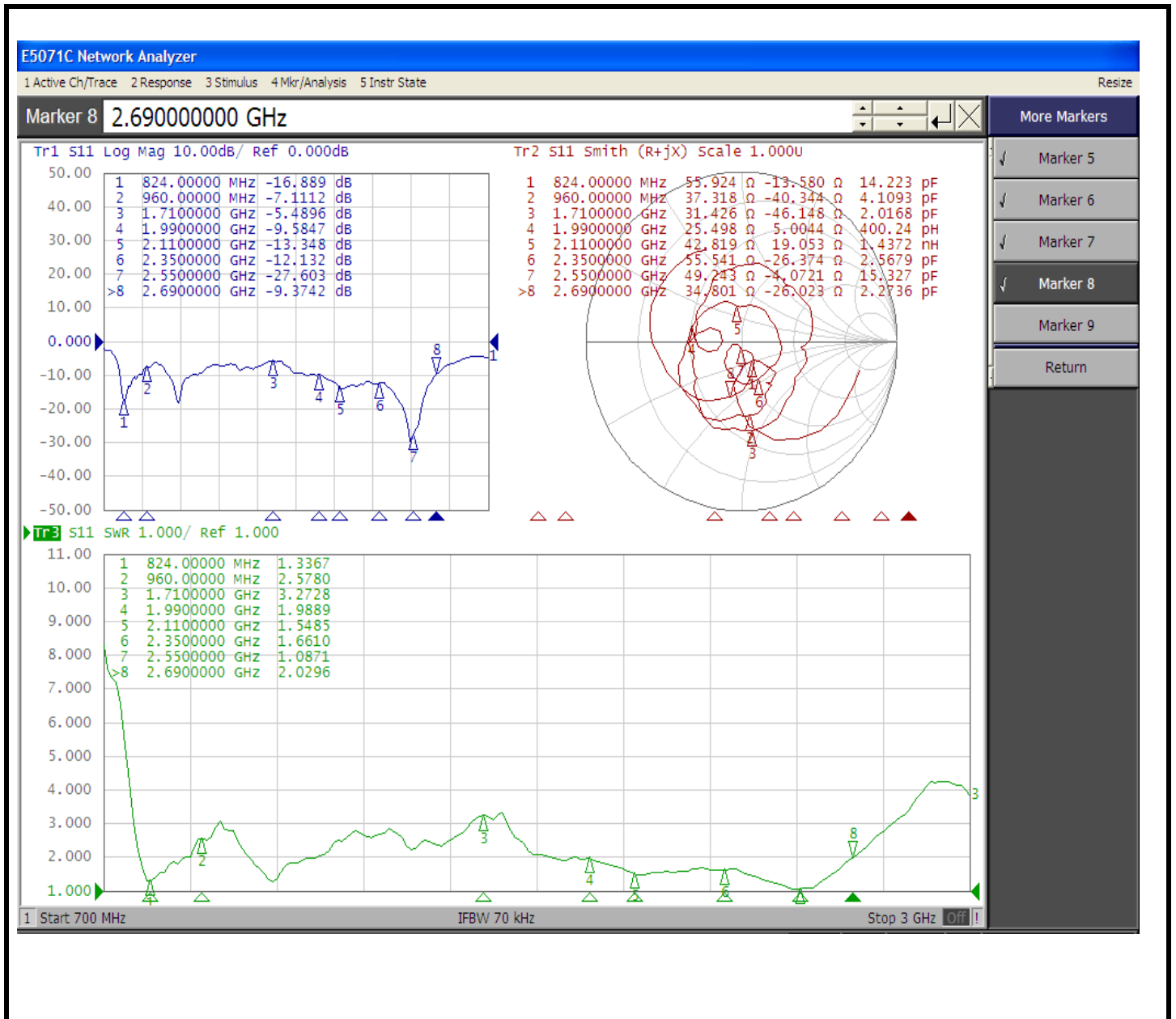

FETUKEJI																
Frequency ID	1	2	3	4	5	6	7	8	9	10	11	12	13	14	15	16
Frequency (MHz)	820.0	830.0	840.0	850.0	860.0	870.0	880.0	890.0	900.0	910.0	920.0	930.0	940.0	950.0	960.0	970.0
Point Values																
Ant. Port Input Pwr. (dBm)	0.00	0.00	0.00	0.00	0.00	0.00	0.00	0.00	0.00	0.00	0.00	0.00	0.00	0.00	0.00	0.00
Tot. Rad. Pwr. (dBm)	-3.43	-3.69	-3.65	-3.76	-3.96	-3.71	-3.29	-3.03	-2.76	-3.06	-3.18	-3.45	-3.89	-3.91	-4.23	-4.53
Peak EIRP (dBm)	0.82	0.74	0.91	0.94	0.99	1.12	1.34	1.41	1.43	1.15	1.01	0.95	0.93	0.66	-0.84	-0.89
Directivity (dBi)	4.06	4.13	4.26	4.39	4.94	4.83	4.64	4.43	4.19	4.21	4.20	4.40	4.31	4.17	3.88	3.64
Efficiency (dB)	-3.43	-3.69	-3.65	-3.76	-3.96	-3.71	-3.29	-3.03	-2.76	-3.06	-3.18	-3.45	-3.89	-3.91	-4.23	-4.53
Efficiency (%)	45.40	42.80	43.20	42.10	40.20	42.50	46.90	49.80	52.90	49.50	48.00	45.20	40.90	40.60	37.80	35.20
Gain (dBi)	0.62	0.44	0.61	0.64	0.99	1.12	1.34	1.41	1.43	1.15	1.01	0.95	0.43	0.26	-0.34	-0.89
NHPRP ±Pi/4 (dBm)	-4.47	-4.78	-4.84	-5.03	-5.27	-5.06	-4.65	-4.39	-4.18	-4.55	-4.78	-5.08	-5.49	-5.51	-5.83	-6.14
NHPRP ±Pi/6 (dBm)	-5.90	-6.15	-6.28	-6.57	-6.93	-6.73	-6.22	-5.89	-5.66	-6.08	-6.42	-6.72	-7.10	-7.08	-7.40	-7.71
NHPRP ±Pi/8 (dBm)	-7.26	-7.41	-7.58	-7.97	-8.45	-8.25	-7.59	-7.11	-6.80	-7.20	-7.55	-7.78	-8.09	-8.04	-8.34	-8.66
Upper Hem. PRP (dBm)	-7.26	-7.55	-7.75	-8.32	-8.67	-8.14	-7.51	-7.23	-7.07	-7.57	-7.78	-7.82	-7.99	-7.85	-8.11	-8.41
Lower Hem. PRP (dBm)	-5.76	-5.99	-5.78	-5.63	-5.75	-5.65	-5.36	-5.10	-4.77	-4.95	-5.04	-5.42	-6.03	-6.16	-6.51	-6.82
Upper Hem. PRP (%)	18.81	17.57	16.77	14.71	13.59	15.34	17.73	18.92	19.63	17.52	16.69	16.51	15.90	16.39	15.45	14.42
Lower Hem. PRP (%)	26.56	25.20	26.41	27.38	26.63	27.21	29.12	30.88	33.31	31.96	31.35	28.69	24.96	24.21	22.34	20.80

FETUKEJI													
Frequency ID	17	19	21	23	25	27	29	31	33	35	37	39	41
Frequency (MHz)	1710.0	1730.0	1750.0	1770.0	1790.0	1810.0	1830.0	1850.0	1870.0	1890.0	1910.0	1930.0	1950.0
Point Values													
Ant. Port Input Pwr. (dBm)	0.00	0.00	0.00	0.00	0.00	0.00	0.00	0.00	0.00	0.00	0.00	0.00	0.00
Tot. Rad. Pwr. (dBm)	-4.93	-5.19	-5.56	-5.04	-4.66	-3.22	-2.95	-2.42	-2.40	-2.04	-2.03	-1.94	-1.80
Peak EIRP (dBm)	-1.03	-1.39	-1.00	-0.16	0.51	2.24	2.47	3.05	3.13	3.31	3.16	3.27	3.49
Directivity (dBi)	3.90	3.80	4.56	4.88	5.17	5.46	5.42	5.47	5.54	5.36	5.18	5.21	5.29
Efficiency (dB)	-4.93	-5.19	-5.56	-5.04	-4.66	-3.22	-2.95	-2.42	-2.40	-2.04	-2.03	-1.94	-1.80
Efficiency (%)	32.20	30.20	27.80	31.40	34.20	47.60	50.70	57.30	57.50	62.50	62.70	64.00	66.10
Gain (dBi)	-1.03	-1.39	-1.00	-0.16	0.51	2.24	2.47	3.05	3.13	3.31	3.16	3.27	3.49
NHPRP ±Pi/4 (dBm)	-6.38	-6.52	-6.73	-6.12	-5.65	-4.13	-3.79	-3.22	-3.18	-2.78	-2.73	-2.61	-2.44
NHPRP ±Pi/6 (dBm)	-7.80	-7.83	-7.93	-7.21	-6.65	-5.07	-4.70	-4.12	-4.06	-3.62	-3.55	-3.41	-3.22
NHPRP ±Pi/8 (dBm)	-8.79	-8.74	-8.78	-7.97	-7.35	-5.76	-5.40	-4.82	-4.75	-4.28	-4.21	-4.10	-3.91
Upper Hem. PRP (dBm)	-8.16	-8.64	-9.08	-8.53	-8.09	-6.58	-6.12	-5.45	-5.33	-4.93	-4.92	-4.83	-4.73
Lower Hem. PRP (dBm)	-7.73	-7.81	-8.10	-7.62	-7.28	-5.92	-5.79	-5.41	-5.50	-5.18	-5.16	-5.06	-4.90
Upper Hem. PRP (%)	15.29	13.69	12.35	14.04	15.51	21.99	24.41	28.54	29.30	32.13	32.23	32.86	33.68
Lower Hem. PRP (%)	16.88	16.55	15.47	17.31	18.71	25.60	26.33	28.77	28.20	30.35	30.47	31.19	32.40

FETUKEJI													
Frequency ID	42	46	50	54	58	62	64	66	68	70	72	73	
Frequency (MHz)	2200.0	2240.0	2280.0	2320.0	2360.0	2400.0	2520.0	2560.0	2600.0	2640.0	2680.0	2700.0	
Point Values													
Ant. Port Input Pwr. (dBm)	0.00	0.00	0.00	0.00	0.00	0.00	0.00	0.00	0.00	0.00	0.00	0.00	
Tot. Rad. Pwr. (dBm)	-1.85	-2.39	-2.15	-2.68	-2.10	-1.88	-2.09	-2.17	-2.60	-3.14	-2.66	-2.61	
Peak EIRP (dBm)	3.52	3.11	3.64	3.25	3.71	4.17	2.94	2.54	1.76	0.89	1.88	2.24	
Directivity (dBi)	5.37	5.50	5.78	5.93	5.81	6.05	5.03	4.71	4.36	4.03	4.55	4.85	
Efficiency (dB)	-1.85	-2.39	-2.15	-2.68	-2.10	-1.88	-2.09	-2.17	-2.60	-3.14	-2.66	-2.61	
Efficiency (%)	65.30	57.70	61.00	53.90	61.70	64.90	61.90	60.60	54.90	48.60	54.20	54.90	
Gain (dBi)	3.52	3.11	3.64	3.25	3.71	4.17	2.94	2.54	1.76	0.89	1.88	2.24	
NHPRP ±Pi/4 (dBm)	-2.56	-3.07	-2.87	-3.44	-2.94	-2.82	-3.60	-3.95	-4.56	-5.22	-4.92	-4.93	
NHPRP ±Pi/6 (dBm)	-3.28	-3.79	-3.60	-4.24	-3.83	-3.71	-4.74	-5.27	-6.04	-6.85	-6.63	-6.71	
NHPRP ±Pi/8 (dBm)	-3.86	-4.37	-4.16	-4.84	-4.43	-4.27	-5.54	-6.18	-7.03	-7.92	-7.76	-7.89	
Upper Hem. PRP (dBm)	-5.91	-6.66	-6.50	-7.13	-6.52	-6.29	-5.37	-4.84	-5.06	-5.76	-5.59	-5.72	
Lower Hem. PRP (dBm)	-4.01	-4.42	-4.13	-4.61	-4.05	-3.83	-4.84	-5.56	-6.25	-6.57	-5.75	-5.52	
Upper Hem. PRP (%)	25.62	21.57	22.37	19.35	22.27	23.49	29.03	32.83	31.18	26.55	27.58	26.79	
Lower Hem. PRP (%)	39.69	36.17	38.61	34.58	39.39	41.37	32.82	27.82	23.72	22.01	26.59	28.06	

820.00MHz@T45P45

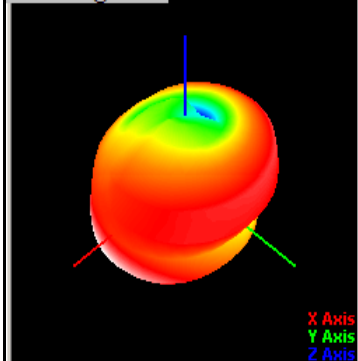

960.00MHz@T45P45

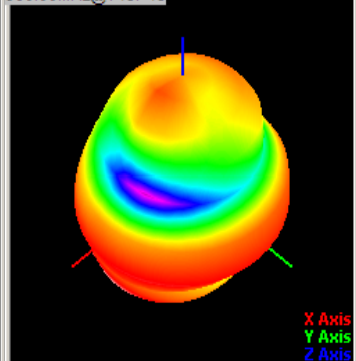

1710.00MHz@T45P45

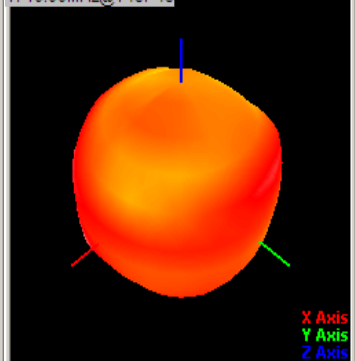

2300.00MHz@T45P45

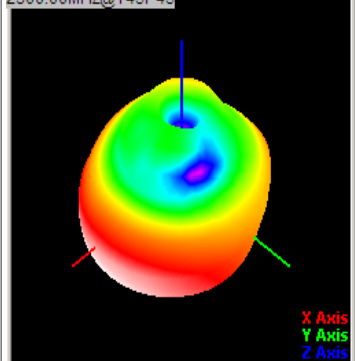

审核人 Checked by	蒋能光	测试人 Tested by	楚欢
-------------------	-----	------------------	----

X-ON Electronics

Largest Supplier of Electrical and Electronic Components

Click to view similar products for [Antennas](#) category:

Click to view products by [HJ Technology](#) manufacturer:

Other Similar products are found below :

[GAN30084EU](#) [930-033-R](#) [EXE902SM](#) [APAMPG-117](#) [MAF94383](#) [W6102B0100](#) [SPDA17RP918](#) [A09-F5NF-M](#) [RGFRA1903041A1T](#) [108-00016-050](#) [W3921B0100](#) [SIMNA-868](#) [SIMNA-915](#) [SIMNA-433](#) [W1049B090](#) [TRABT1560](#) [A75-001](#) [W3118A](#) [WTL2449CQ1-FRSMM](#) [CPL9C](#) [0600-00060](#) [GD5W-28P-NF](#) [MA9-7N](#) [GD53-25](#) [C37](#) [MAF94051](#) [FRX380](#) [MA9-5N](#) [B1322NR](#) [QWFTB120](#) [MAF94271](#) [MAF94300](#) [GPSMB301](#) [FG4403](#) [PSQ24495-91RSM](#) [MIKROE-2393](#) [DA5-32RADOME](#) [5200227](#) [GPSCPMM00](#) [W1049B030](#) [SPDA17RP918](#) [GPSCP00](#) [AN 303](#) [ANTDOM-05-01-WPM](#) [EXW30BNX](#) [OSCAR1A/5M/SMAM/S/S/31](#) [ALPHA4A/1M/SMAM/S/S/26](#) [OSCAR1A/10M/SMAM/S/S/31](#) [OSCAR40/5M/LL/SMAM/S/S/33](#) [OSCAR40/10M/LL/SMAM/S/S/33](#)