



东莞市皇捷通讯科技有限公司

DONGGUAD HUANG JIE COMMUNI CAT ION TECHNOLOGY CO.,LTD.

3N0401BK-033

2.4GHz ISM Flexible Polymer

Key Features

2.4 GHz ISM
2400-2500 MHz

Embedded Antenna
Wifi Antenna
High Performance
Ground Plane Independent
Self-Adhesive

Dimensions 33.5x 6.5mm
ustomizable Cable and Connecto

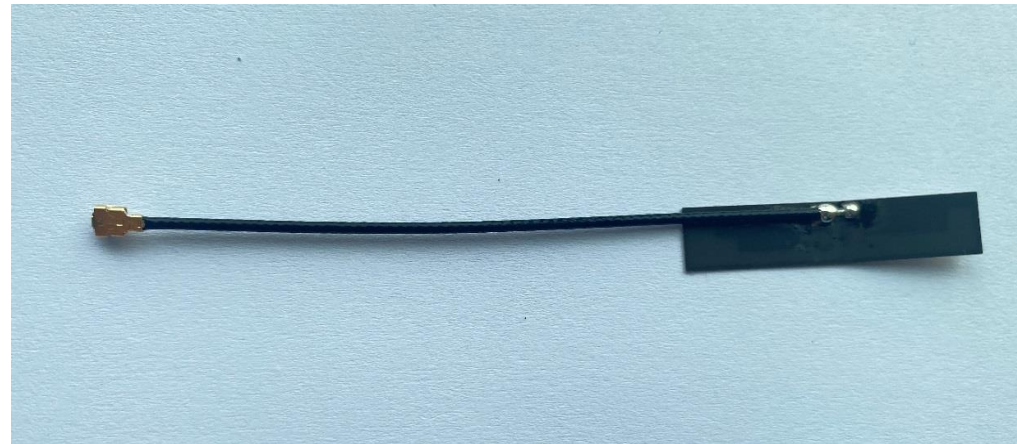

Description

3N0401BK-033 antenna is flexible high efficiency embedded solution covering 2.4 GHz. Antenna can be easily mounted in most devices due to self-adhesive layer and small size. 3N0401BK-033 is omnidirectional, ground plane independent antenna. Cable and connector is upon request.

东莞市皇捷通讯科技有限公司
地址:广东省东莞市寮步镇泉塘大岷地工业区
网址:www.iphone-line.com
电话:0769-83328111 FAX:83327688





Antenna and electrical specifications

Parameters	2.4GHz ISM Flexible Polymer
Standards	WiFi
Band (MHz)	2.4GHz
Frequency (MHz)	2400-2500 MHz
Return Loss (dB)	-15.6
VSWR	<2.0
Efficiency (%)	40-60
Peak Gain (dBi)	2
Impedance (Ohm)	50
Polarisation	Linear
Radiation Pattern	Omni-Directional
Max. Input Power (W)	25
Connector Type	Most RF Connectors (U.FL Standard)
Cable Length	Any Cable Length (80mm Standard)
Cable Type	Other Cables Available (1.13mm Standard)

Antenna Measurement Conditions:

Mounted 40x10x0.3 Cm ABS Plastic Plate

Measured in Certified CTIA 3DAnechoic Chamber



Mechanical and environmental specifications

Specifications	3N0401BK-033
Mounting Type	Self-Adhesive
Dimensions (mm)	33.5x 6.5mm
Adhesive Type	3M
Material	Flexible Polymer
Operating Temperature (C)	-40 to +85
Storage Temperature (C)	-40 to +85
Substance Compliance	RoHS

6	7	8
REVISION	DESCRIPTION	DATE
A0	首次发行	21.06.05
		DRAFTER
		S.He

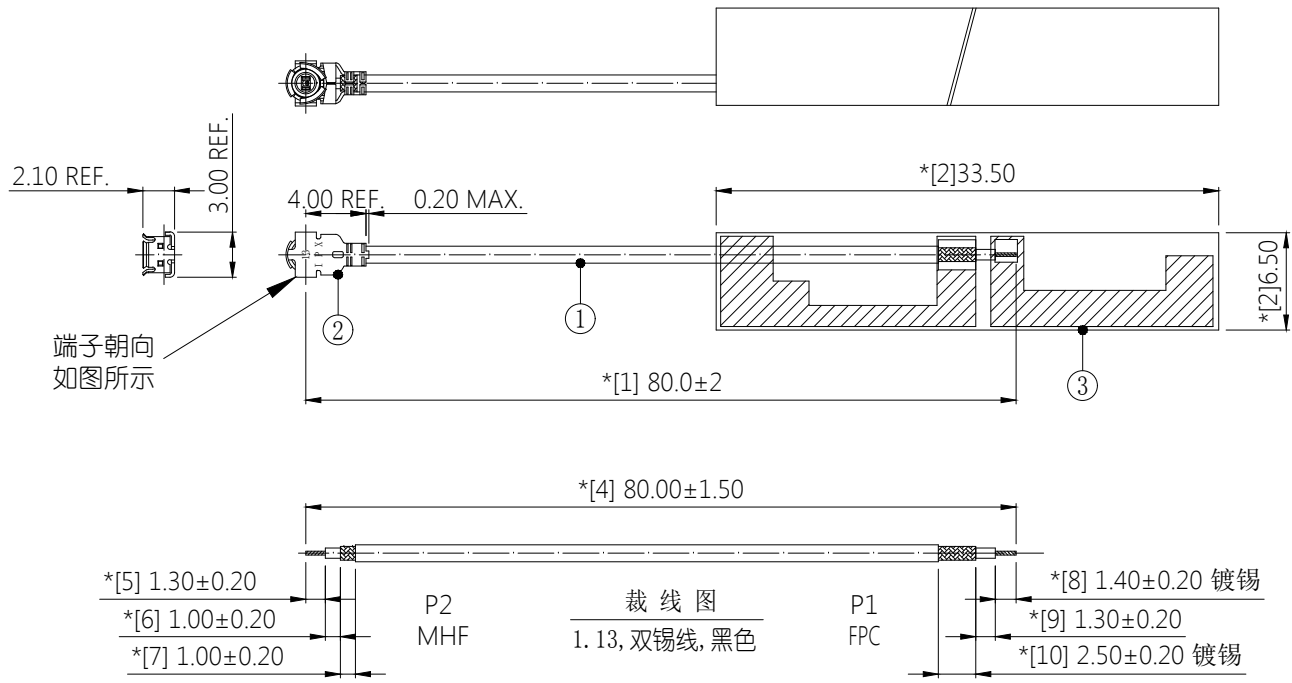

每批次需做成品首件确认

- 技术要求:
- 1 方向要求: 如图所示。
 - 2 电气特性: 特性阻抗:50Ω; 频率范围:2.40GHz-2.50GHz;
检验方法: 单测天线, 使用网络分析仪100%比对Gold sample波形测试。
 - 3 拔出力测试: 最小1.30kgf。
测试方法: 沿电缆中心轴, 以约25±3毫米/分钟的速度, 垂直将1.30kg砝码提离桌面即为合格。
 - 4 尺寸检验: [*]为FAI检测项目; *为重点检测项目; ■为CPK管制项目。
 - 5 外观检验: 电缆裁切须平整, 镀锡须光亮, 导体不得有多余股数伸出与散乱;
FPC不得有划痕、刮伤、露铜等不良, 焊接须饱满, 不得有假焊、虚焊、毛刺;
电缆外被不得有破损、折皱及异色等不良。
检验方法: 目视全检。
 - 6 包装规范: 25CS/扎, 2扎/包
 - 7 环保要求: 产品及其使用之物料皆需要符合RoHS要求。

3	2YF128	FPC L33.50*W6.50mm, 两面喷黑油	1	---
2	2LM10P113210	MHF I PLUG FOR OD1.13 CABLE	1	---
1	2C5M11312BK1	OD1.13黑色双锡线-50 OHM	1	---
NO	PART NUMBER	PART NAME & DESCRIPTION	Q'TY	REMARKS

GENERAL TOLERANCE:
LINEAR:
X ±0.20
X.X ±0.15
X.XX ±0.05
X.XXX ±0.01
ANGLE:
X° ±4.00°
X.X° ±3.00°
X.XX° ±2.00°
X.XXX° ±1.00°

HJ-Tech 东莞市皇捷通讯科技有限公司

FILE NAME: 产品图
TITLE: 内置天线
1.13黑色双锡线, P1端焊接FPC (2YF128), P2端打一代端子, 线长80mm (RF2106001)

ENG/DATE: SQW/21.06.05
CHE/DATE: .
P/N: 3N0401BK-033

APP/DATE: .
UNIT: mm
SCALE: 1:1
REVISION: A0
SHEET: 1/1

COMPLIANCE WITH THE REQUIREMENT: ■RoHS; □HF; □SONY SS-00259; □OTHERS
*NO USING ESTRICTED AND BANNED SUBSTANCE

H563

实物照片

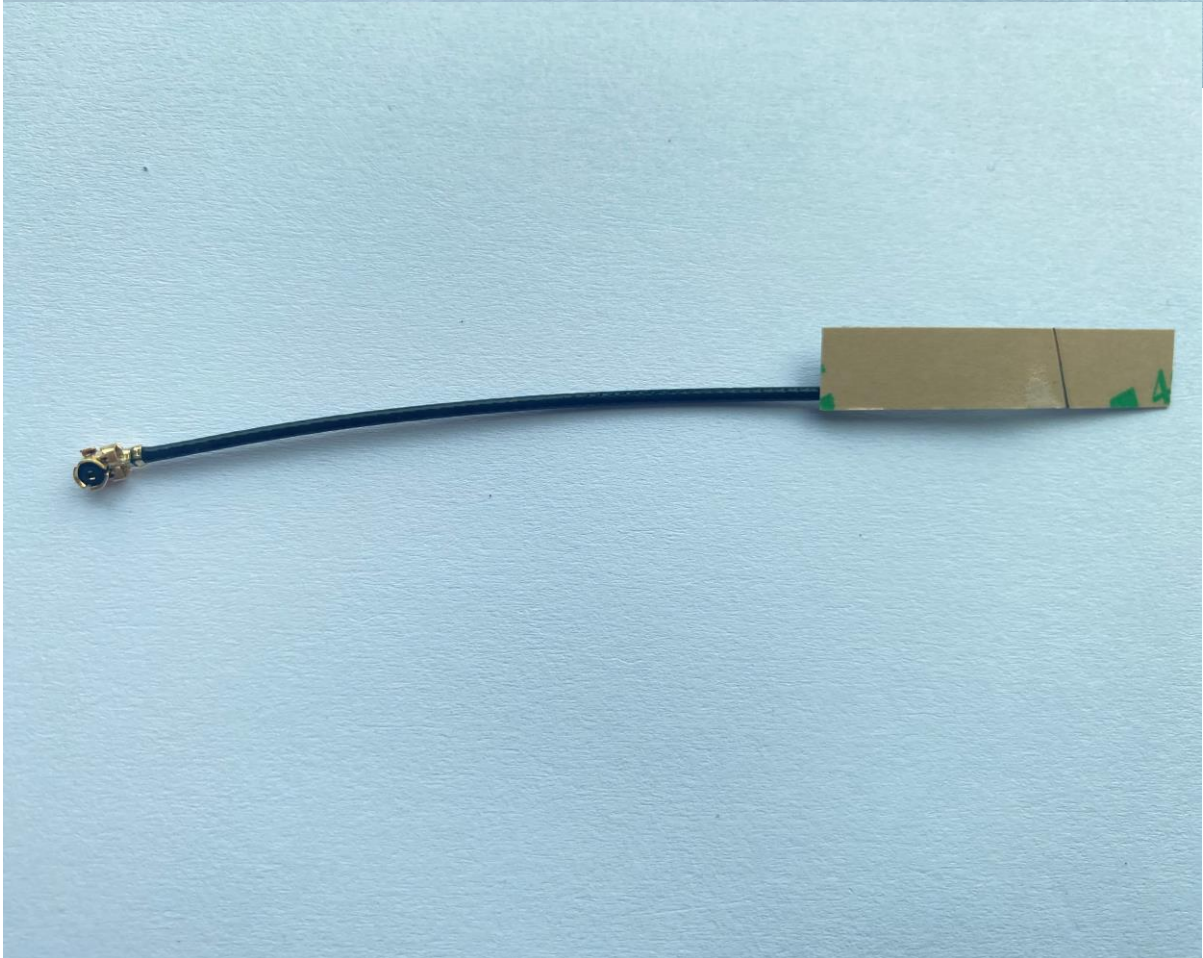
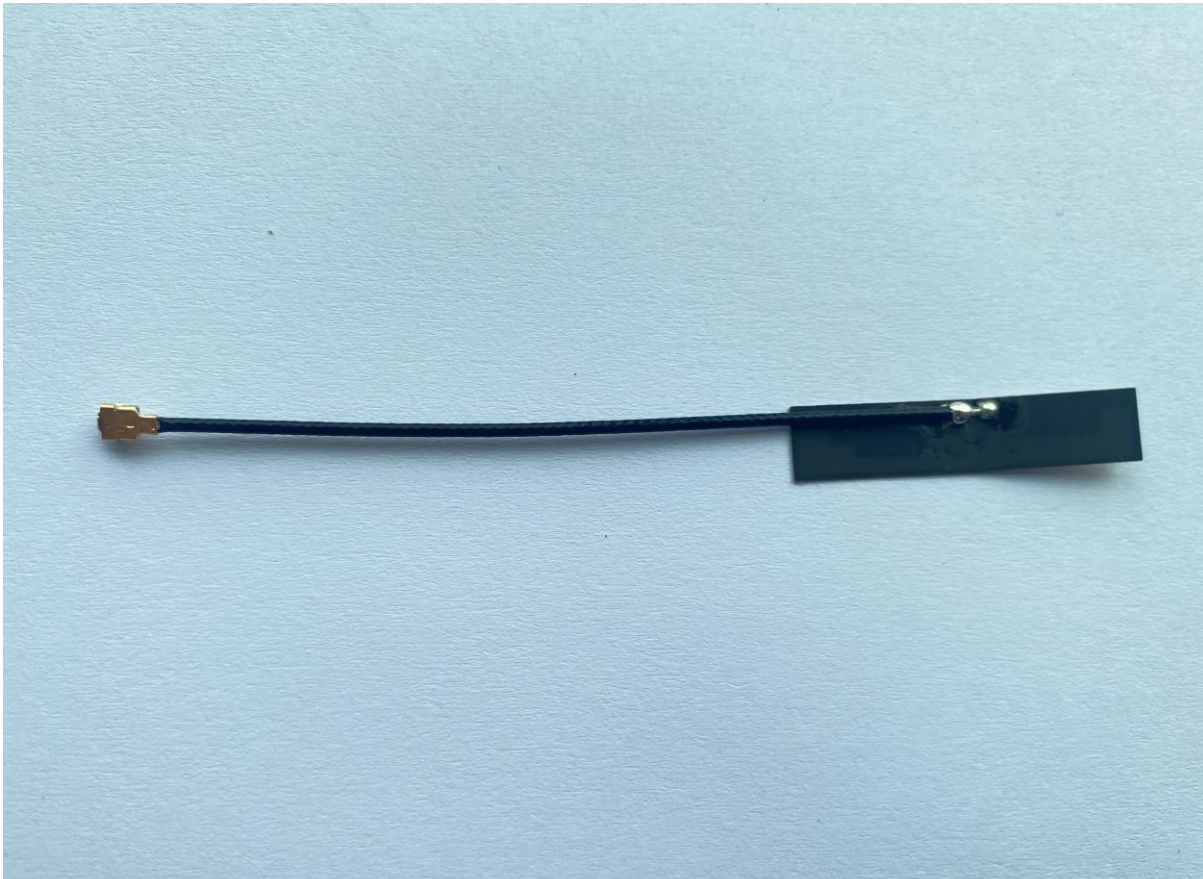

网络测试报告

1. 测试图



2. Smith

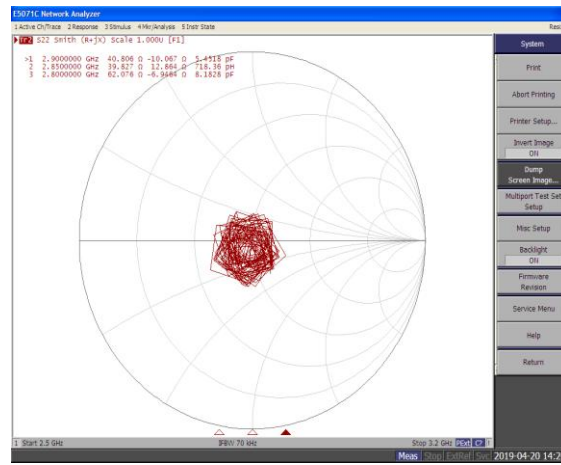

3. LOGMAG

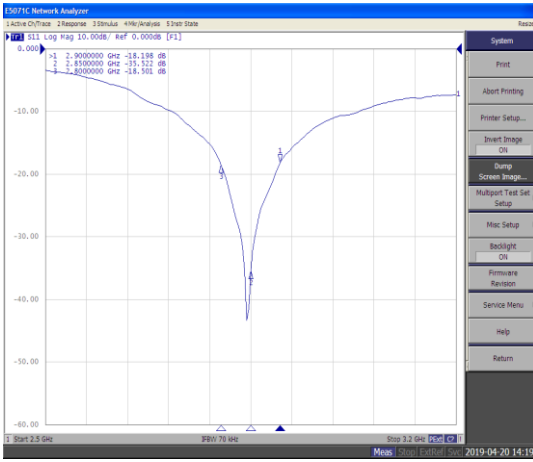

4. SWR

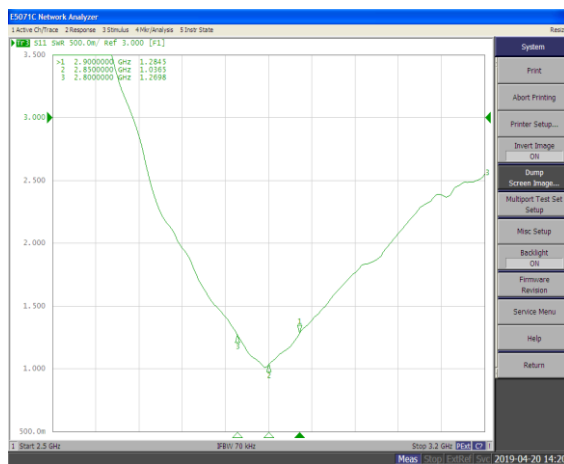

5 总图

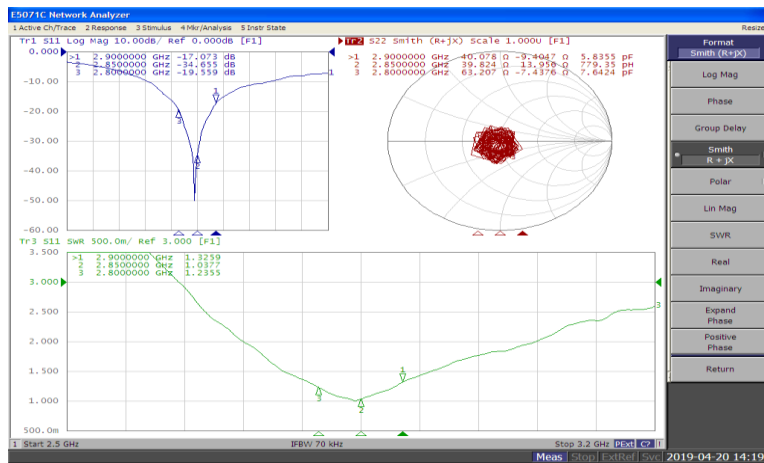

Antenna Test Report (Passive)

Nokia8210

Date:

2019/4/20

v1.3

Comments:

This antenna is good. Yeah!

Eric

Test Point ID	Freq. (MHz)	TRP (dBm)	Gain (dBi)	Directivity (dBi)	Efficiency (%)	Efficiency (dB)	Max (dBm)	Theta of Max	Phi of Max	Min (dBm)	Theta of Min	Phi of Min	AVG (dBm)	Max/Min (dB)	Max/AVG (dB)	Min/AVG (dB)
1	2400.0	2400.00	-2.80	4.61	18.2%	-7.40	-2.80	180	30	-10.20	60	240	-7.76	7.41	4.97	-2.44
2	2413.8	2413.79	-2.12	5.22	18.4%	-7.34	-2.12	180	30	-10.26	120	0	-7.54	8.14	5.42	-2.72
3	2427.6	2427.59	-1.79	4.93	21.3%	-6.72	-1.79	180	30	-10.59	120	30	-6.82	8.80	5.03	-3.77
4	2441.4	2441.38	-1.98	4.47	22.7%	-6.45	-1.98	180	30	-11.57	120	30	-6.67	9.59	4.70	-4.90
5	2455.2	2455.17	-2.17	4.07	23.7%	-6.25	-2.17	90	300	-12.31	120	30	-6.78	10.14	4.60	-5.54
6	2469.0	2468.97	-2.24	3.80	24.9%	-6.03	-2.24	90	300	-12.47	0	30	-6.78	10.23	4.54	-5.69
7	2482.8	2482.76	-2.23	3.77	25.2%	-5.99	-2.23	150	270	-13.04	0	0	-6.77	10.82	4.54	-6.27
8	2496.6	2496.55	-1.68	4.13	26.2%	-5.81	-1.68	180	90	-11.76	0	0	-6.41	10.08	4.73	-5.35
9	2500.0	2510.34	-1.27	4.06	29.3%	-5.33	-1.27	120	270	-9.67	180	60	-5.72	8.40	4.45	-3.95
31	--	--	--	--	--	--	--	--	--	--	--	--	--	--	--	--
32	--	--	--	--	--	--	--	--	--	--	--	--	--	--	--	--
33	--	--	--	--	--	--	--	--	--	--	--	--	--	--	--	--
34	--	--	--	--	--	--	--	--	--	--	--	--	--	--	--	--
35	--	--	--	--	--	--	--	--	--	--	--	--	--	--	--	--
36	--	--	--	--	--	--	--	--	--	--	--	--	--	--	--	--
37	--	--	--	--	--	--	--	--	--	--	--	--	--	--	--	--
38	--	--	--	--	--	--	--	--	--	--	--	--	--	--	--	--
39	--	--	--	--	--	--	--	--	--	--	--	--	--	--	--	--
40	--	--	--	--	--	--	--	--	--	--	--	--	--	--	--	--

[Go to Cover Page](#)

Passive -Freq2400.00MHZ

		0	60	120	180	240	300	360
H+V Total (30° Step)	0	-8.68	-8.53	-7.43	--	--	--	--
	30	-9.00	-8.07	-8.22	-10.07	-10.02	-8.84	--
	60	-9.14	-8.23	-7.31	-9.48	-10.20	-8.31	--
	90	-9.31	-8.59	-8.27	-9.90	-10.00	-4.79	--
	120	-9.52	-8.47	-7.27	-8.83	-8.65	-7.22	--
	150	-8.74	-8.96	-8.37	-9.90	-9.15	-6.45	--
	180	-8.56	-7.54	-6.64	--	--	--	--
		0	60	120	180	240	300	360
H (30° Step)	0	-27.83	-9.74	-8.62	--	--	--	--
	30	-23.60	-9.72	-10.64	-29.36	-10.96	-11.66	--
	60	-24.94	-9.73	-9.10	-25.48	-11.12	-9.54	--
	90	-22.53	-9.98	-10.74	-31.82	-11.64	-4.89	--
	120	-23.52	-10.22	-9.11	-28.91	-11.26	-8.71	--
	150	-21.90	-10.57	-10.63	-38.86	-11.69	-7.72	--
		0	60	120	180	240	300	360
V (30° Step)	0	-8.73	-14.66	-13.65	--	--	--	--
	30	-9.15	-13.06	-11.92	-10.12	-17.12	-12.05	--
	60	-9.26	-13.59	-12.02	-9.59	-17.41	-14.38	--
	90	-9.52	-14.23	-11.90	-9.93	-15.01	-21.07	--
	120	-9.70	-13.26	-11.90	-8.87	-12.11	-12.58	--
	150	-8.96	-14.06	-12.30	-9.91	-12.69	-12.41	--
	180	-8.81	-8.64	-11.98	--	--	--	--

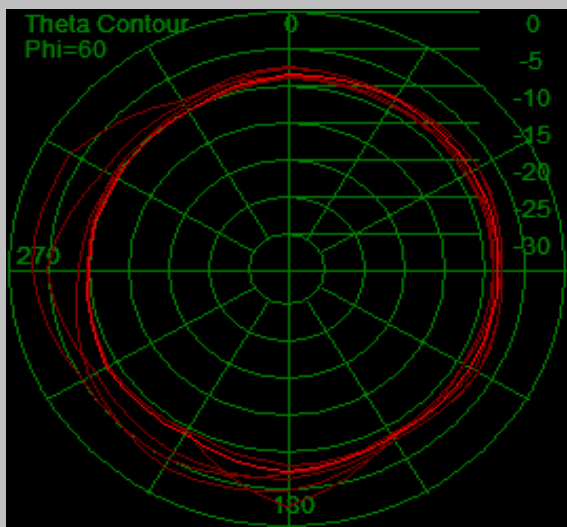
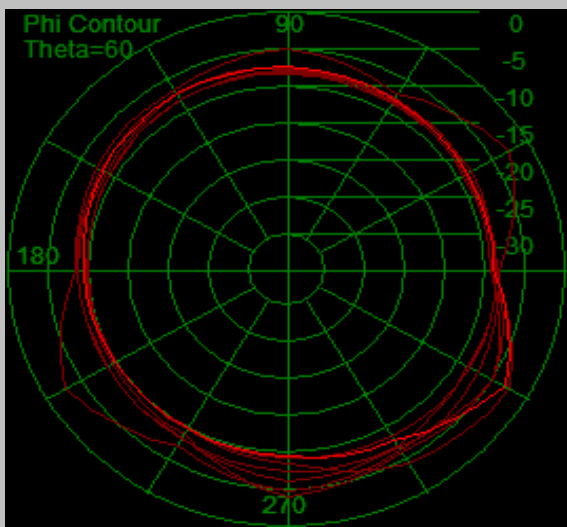
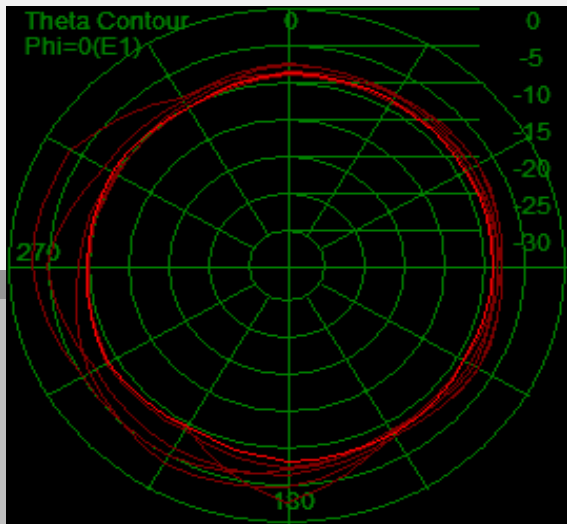
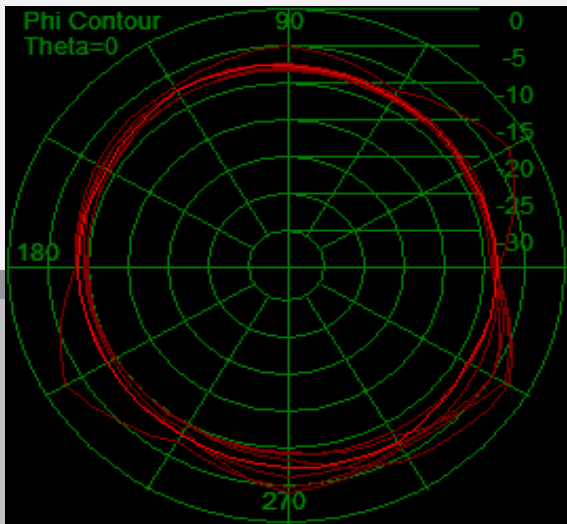

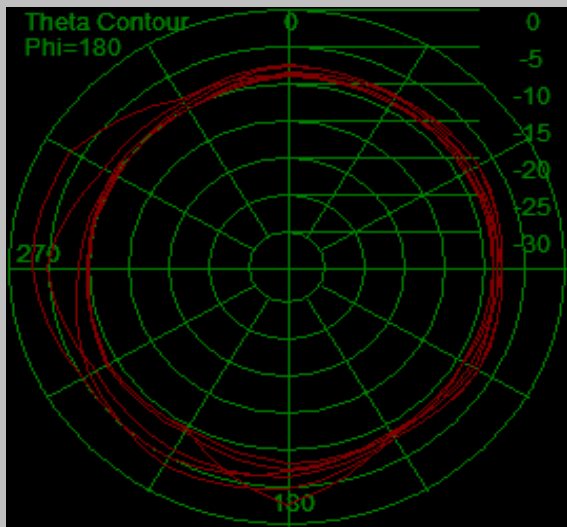
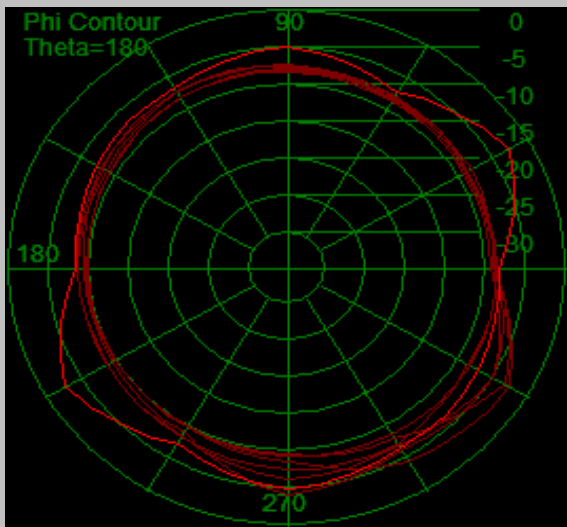
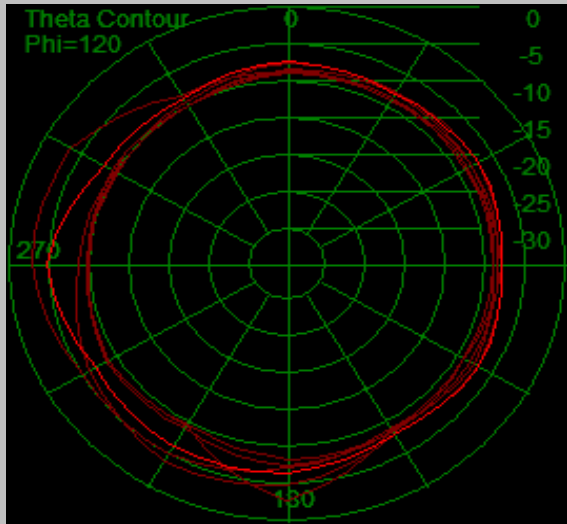
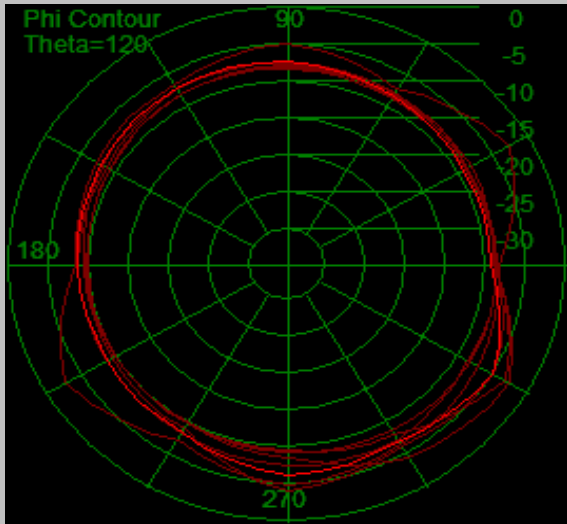

[Go to Cover Page](#)

Passive -Freq2500MHZ

		0	60	90	120	180	240	270	360
H+V Total (30° Step)	0	-9.10	-7.44	-7.21	-6.98	--	--	--	--
	30	-7.29	-6.11	-6.89	-6.96	-7.00	-6.32	-5.83	--
	60	-7.34	-6.71	-6.67	-6.55	-6.36	-5.61	-4.88	--
	90	-7.09	-7.32	-7.73	-7.75	-6.62	-5.55	-3.46	--
	120	-7.06	-6.12	-6.22	-6.42	-5.90	-3.63	-1.27	--
	150	-6.17	-7.99	-8.30	-8.36	-6.91	-4.30	-1.70	--
	180	-5.31	-9.67	-1.34	-4.32	--	--	--	--
H (30° Step)	0	-20.90	-10.45	-7.59	-8.47	--	--	--	--
	30	-18.64	-7.96	-7.16	-9.48	-30.00	-7.85	-6.16	--
	60	-18.70	-9.69	-6.91	-8.03	-22.61	-6.94	-5.14	--
	90	-17.15	-8.84	-8.12	-10.39	-35.96	-7.53	-4.00	--
	120	-16.90	-9.64	-6.46	-7.62	-26.94	-6.37	-2.19	--
	150	-14.98	-9.91	-8.71	-10.71	-31.94	-6.95	-2.84	--
	180	-13.46	-13.65	-1.83	-4.89	--	--	--	--
V (30° Step)	0	-9.40	-10.46	-18.06	-12.35	--	--	--	--
	30	-7.62	-10.72	-19.06	-10.53	-7.02	-11.61	-17.28	--
	60	-7.67	-9.75	-19.35	-11.94	-6.47	-11.42	-17.24	--
	90	-7.54	-12.62	-18.41	-11.18	-6.63	-9.91	-12.84	--
	120	-7.54	-8.68	-18.93	-12.59	-5.94	-6.93	-8.47	--
	150	-6.79	-12.48	-18.81	-12.16	-6.93	-7.70	-8.09	--
	180	-6.03	-11.89	-11.10	-13.44	--	--	--	--

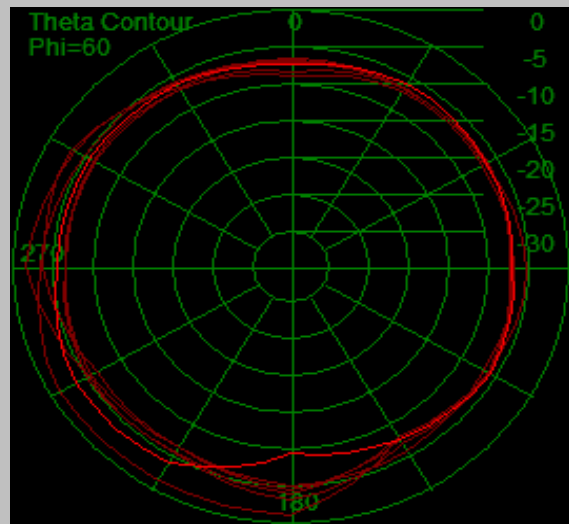
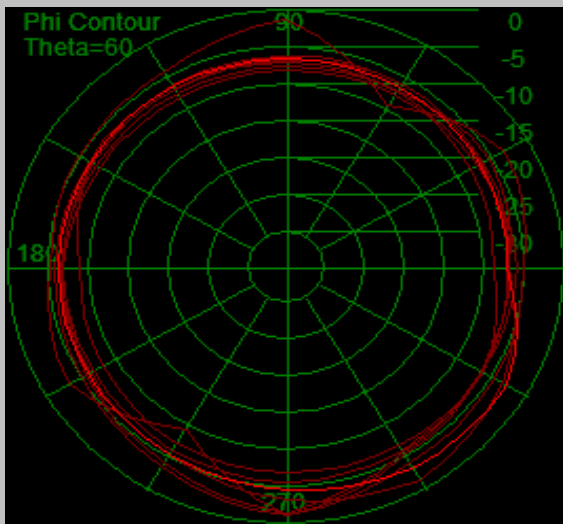
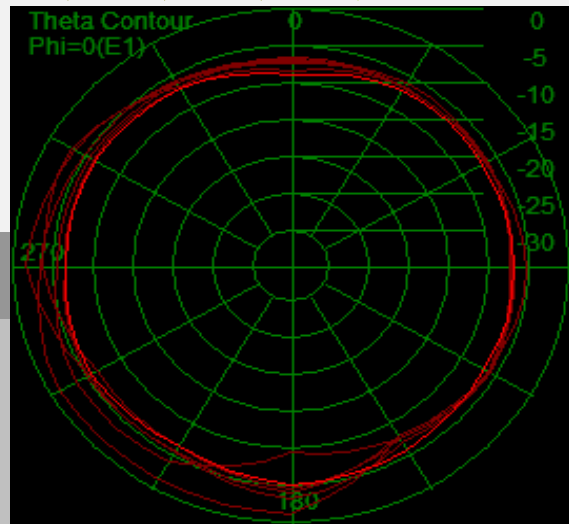
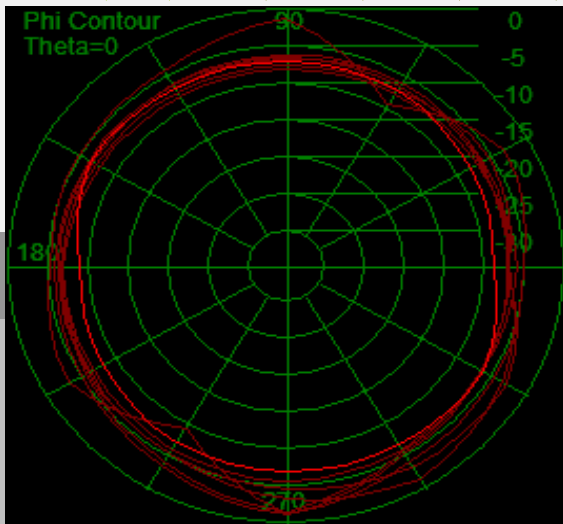

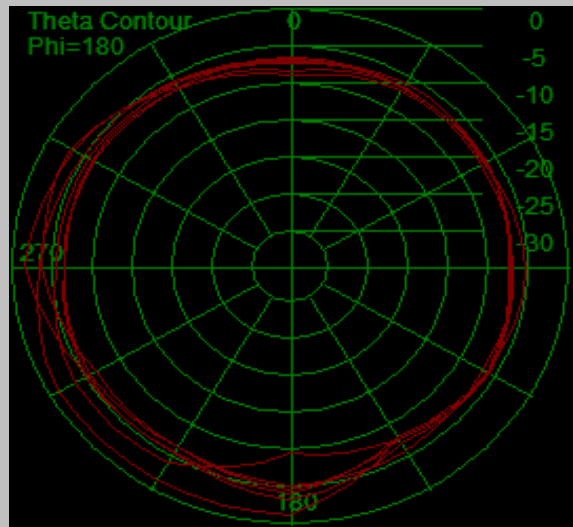
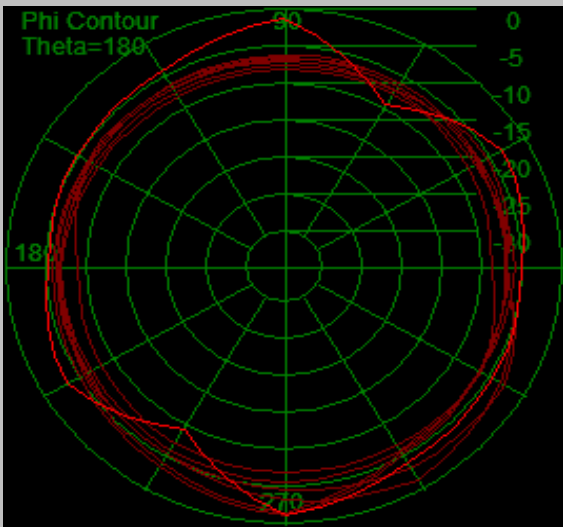
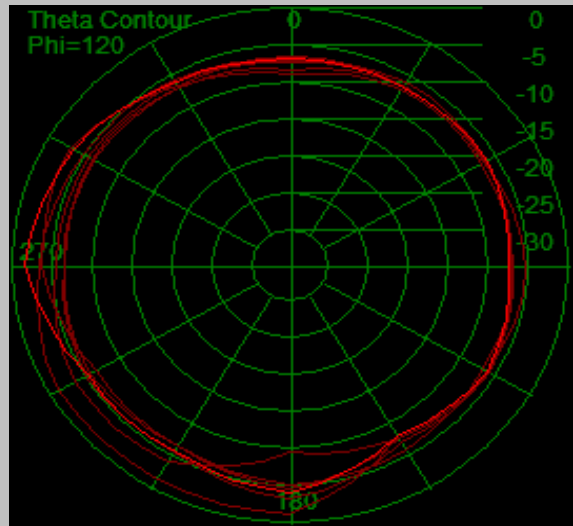
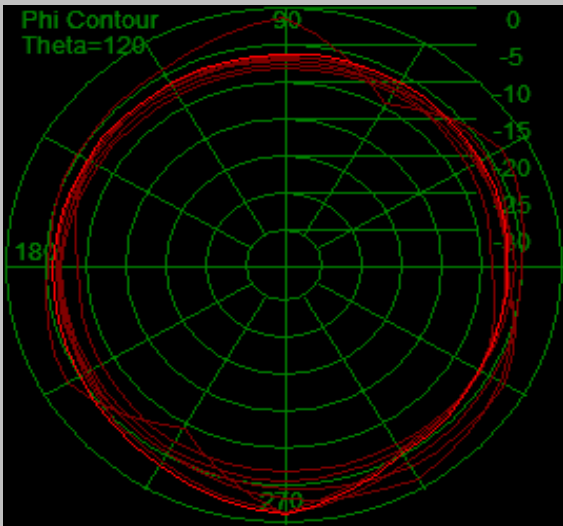

X-ON Electronics

Largest Supplier of Electrical and Electronic Components

Click to view similar products for [Antennas](#) category:

Click to view products by [HJ Technology](#) manufacturer:

Other Similar products are found below :

[GAN30084EU](#) [930-033-R](#) [EXE902SM](#) [APAMPG-117](#) [MAF94383](#) [W6102B0100](#) [SPDA17RP918](#) [A09-F5NF-M](#) [RGFRA1903041A1T](#) [108-00016-050](#) [W3921B0100](#) [SIMNA-868](#) [SIMNA-915](#) [SIMNA-433](#) [W1049B090](#) [TRABT1560](#) [A75-001](#) [W3118A](#) [WTL2449CQ1-FRSMM](#) [CPL9C](#) [0600-00060](#) [GD5W-28P-NF](#) [MA9-7N](#) [GD53-25](#) [C37](#) [MAF94051](#) [FRX380](#) [MA9-5N](#) [B1322NR](#) [QWFTB120](#) [MAF94271](#) [MAF94300](#) [GPSMB301](#) [FG4403](#) [PSQ24495-91RSM](#) [MIKROE-2393](#) [DA5-32RADOME](#) [5200227](#) [GPSCPMM00](#) [W1049B030](#) [SPDA17RP918](#) [GPSCP00](#) [AN 303](#) [ANTDOM-05-01-WPM](#) [EXW30BNX](#) [OSCAR1A/5M/SMAM/S/S/31](#) [ALPHA4A/1M/SMAM/S/S/26](#) [OSCAR1A/10M/SMAM/S/S/31](#) [OSCAR40/5M/LL/SMAM/S/S/33](#) [OSCAR40/10M/LL/SMAM/S/S/33](#)