

RoHS & HF Compliant

NOTE:

1. Material:

Housing: PBT Bogen606 White;Thermoplastics,UL94V-0(Halogen free);
 Contact: Copper Alloy(C5191),t=0.25±0.05mm
 Shell: Stainless Stell (SUS304) t=0.30±0.05mm
 Outer Shell:PBT Bogen606 White;Thermoplastics,UL94V-0;(Halogen free)

2. FINISH:

Contact: Au 3u" Plated on Contact Area,
 80u" Min.Matte Tin Plated on Solder Tails Area,
 50u" Min.Nickel Underplating Over All.

Shell: 50u" Min.Nickel Underplating Over All.

3. Specification:

3.1: Rated current: 2 A

Insulation Resistance:

1000MΩ Min. at 500V/DC for 1Minute.

Withstanding voltage: 500 VAC/minute

Contact Resistance: 30mΩ Max.

3.2: MECHANICAL

Mating force: 8N-25N (1-5 Cycles)

6N-25N (3000-3005 Cycles)

Unmating force: 10N-25N(1-5 Cycles)

8N-25N (3000-3005 Cycles)

Durability: 3000 cycles Min.

4. All Material must be halogen free

5. Spray test 48 Hours.

6. Ordering information

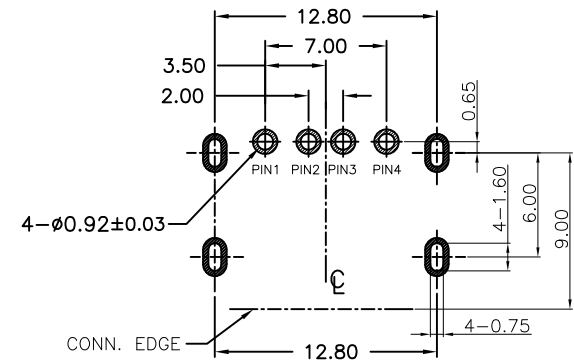
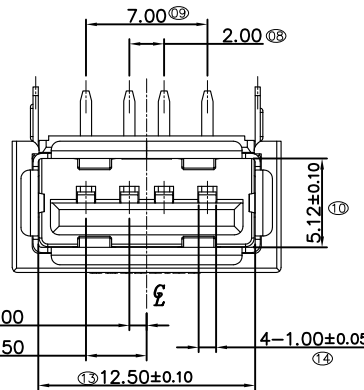
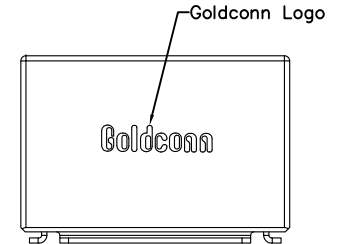
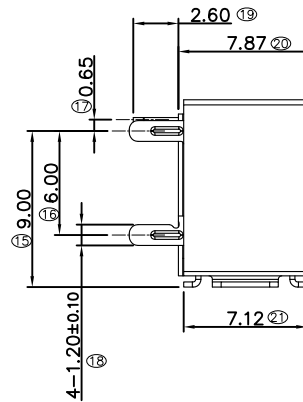
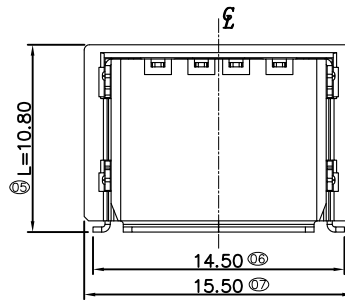
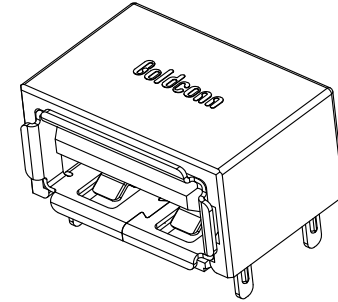
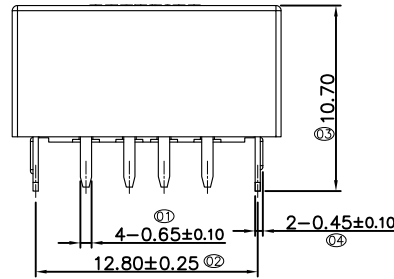

RECOMMENDED PCB LAYOUT(TOP VIEW)
 GENERAL TOLERANCES:±0.05

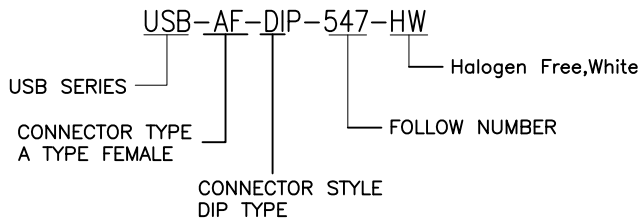

4	OUT SHELL	HUB84T-1A2-WX00-H	PBT Bogen606 白色, 无卤	/
3	SHELL	GUB102U-1D1-SN48	不锈钢SUS304外壳 镀镍盐雾48H	
2	HOUSING	HUB83T-1B1-WX00-H	PBT Bogen606 白色, 无卤	
1	CONTACT	GUB43P-1C1-NW03	磷铜C5191 镀半金雾锡3u"	
项次 NO.	品称 NAME	料号 P/N	表面处理 PLATING	备注 REMARK

A2	MODIFY OUTER SHELL	19.02.13	LUA	YSH
A1	MODIFY OUTER SHELL	18.09.27	LUA	YSH
AO	NEW ISSUE	18.05.15		
版本 REV.	設變內容 MODIFICATION	日期 DATE	修改 DRAW	核准 APPROVE

單位 UNIT	mm	*. Inspection Item	HJ-Tech 东莞市皇捷通讯科技有限公司
比例 SCALE	1:1	Control Item	DONGGIAN HUANGJIE COMMUNICATION TECHNOLOGY CO., LTD.
張數 SHEET	1/1	TOLERANCE UNLESS OTHERWISE SPECIFIED	圖號 Dwg No.
製圖 DRAWING	LUA	.X±0.30 .X'± 3'	名稱 TITLE
審核		.XX±0.20 .X'± 1'	USB AF 4P 90度插板插脚四支脚有护套 (PBT全白配,半金雾锡3u",H=7.87)
審核		.XXX±0.10 .XX±	角法 PROJ.
			客户图

X-ON Electronics

Largest Supplier of Electrical and Electronic Components

Click to view similar products for [USB Connectors](#) category:

Click to view products by [HJ Technology](#) manufacturer:

Other Similar products are found below :

[950](#) [A-USB B-TOP-C](#) [MUSBA511N5](#) [MUSBC111M5](#) [MUSBD11135](#) [17-200721](#) [217450-1](#) [KMBVX-TH-5S-B30](#) [896-30-004-00-000000](#)
[KUSBX-AS2N-W](#) [KUSBX-SMT2AP1S-W30](#) [935](#) [957](#) [30-498-6](#) [SK-60A-2](#) [1734082-1](#) [30-1574](#) [30-470](#) [30-489](#) [30-541](#) [30-572-3](#) [A-USB](#)
[A-2P-C](#) [MIKROE-1451](#) [USBFTV2PEM2G](#) [USBFTVSCCG](#) [4689-1](#) [1-1734084-2](#) [MUSBC11135](#) [USBF21ZNSCC](#) [USBBFTV6ZC](#)
[MUSBB151341](#) [10135326-001LF](#) [M9177/3-1](#) [TJ-105](#) [USB-A-S-F-B-VT](#) [4198](#) [690-024-633-031](#) [UB-20PMFP-LC7001](#) [USBFTVC6MRG](#)
[UA-20BMFA-SL8001](#) [17-200011](#) [USBFTVC7ZC](#) [UB-20AFMM-LL7A01](#) [USBFTVC2MN](#) [CAP-WCCMLPB1](#) [1310-1031-01](#) [2041386-1](#)
[2274475-3](#) [UB-20BMFA-SL8001](#) [UB-20PMFP-SC8003](#)