

- ★ Green Device Available
- ★ Super Low Gate Charge
- ★ Excellent CdV/dt effect decline
- ★ Advanced high cell density Trench technology

Product Summary



BVDSS	R _{DS(on)}	I _D
-20V	95mΩ	-2.3A

Description

The 2301V is the high cell density trenched P-ch MOSFETs, which provide excellent R_{DS(on)} and efficiency for most of the small power switching and load switch applications.

The 2301V meet the RoHS and Green Product requirement with full function reliability approved.

SOT23 Pin Configuration

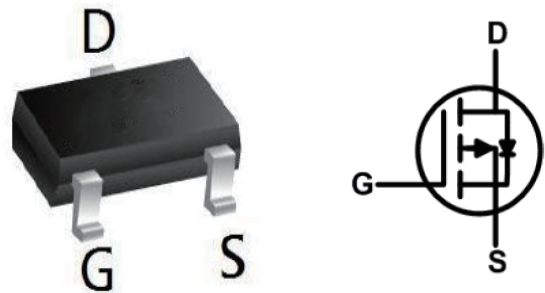

Absolute Maximum Ratings

Symbol	Parameter	Rating	Units
V _{DS}	Drain-Source Voltage	-20	V
V _{GS}	Gate-Source Voltage	±12	V
I _{D@TA=25°C}	Continuous Drain Current, V _{GS} @ 10V ¹	-2.3	A
I _{D@TA=70°C}	Continuous Drain Current, V _{GS} @ 10V ¹	-1.4	A
I _{DM}	Pulsed Drain Current ²	-8	A
P _{D@TA=25°C}	Total Power Dissipation ³	0.8	W
T _{STG}	Storage Temperature Range	-55 to 150	°C
T _J	Operating Junction Temperature Range	-55 to 150	°C

Thermal Data

Symbol	Parameter	Typ.	Max.	Unit
R _{θJA}	Thermal Resistance Junction-Ambient ¹	---	156	°C/W
R _{θJC}	Thermal Resistance Junction-Case ¹	---	---	°C/W

Electrical Characteristics ($T_J = 25^\circ\text{C}$ unless otherwise specified)

Symbol	Parameter	Test Condition	Min.	Typ.	Max.	Units
Off Characteristic						
$V_{(BR)DSS}$	Drain-Source Breakdown Voltage	$V_{GS}=0V, I_D = -250\mu A$	-20	-	-	V
I_{DSS}	Zero Gate Voltage Drain Current	$V_{DS} = -20V, V_{GS} = 0V,$	-	-	-1	μA
I_{GSS}	Gate to Body Leakage Current	$V_{DS}=0V, V_{GS} = \pm 12V$	-	-	± 100	nA
On Characteristics						
$V_{GS(th)}$	Gate Threshold Voltage	$V_{DS}= V_{GS}, I_D = -250\mu A$	-0.4	-0.7	-1	V
$R_{DS(on)}$	Static Drain-Source on-Resistance note2	$V_{GS} = -4.5V, I_D = -2A$	-	95	125	$m\Omega$
		$V_{GS} = -2.5V, I_D = -1A$	-	135	190	
Dynamic Characteristics						
C_{iss}	Input Capacitance	$V_{DS} = -10V, V_{GS} = 0V, f = 1.0MHz$	-	185	-	pF
C_{oss}	Output Capacitance		-	35	-	pF
C_{rss}	Reverse Transfer Capacitance		-	25	-	pF
Q_g	Total Gate Charge	$V_{DS} = -10V, I_D = -2A, V_{GS} = -4.5V$	-	2.2	-	nC
Q_{gs}	Gate-Source Charge		-	0.5	-	nC
Q_{gd}	Gate-Drain("Miller") Charge		-	0.5	-	nC
Switching Characteristics						
$t_{d(on)}$	Turn-on Delay Time	$V_{DD} = -10V, R_L = 5\Omega, R_{GEN} = 3\Omega,$ $V_{GS} = -4.5V,$	-	10	-	ns
t_r	Turn-on Rise Time		-	30	-	ns
$t_{d(off)}$	Turn-off Delay Time		-	63	-	ns
t_f	Turn-off Fall Time		-	50	-	ns
Drain-Source Diode Characteristics and Maximum Ratings						
I_S	Maximum Continuous Drain to Source Diode Forward Current		-	-	-2	A
I_{SM}	Maximum Pulsed Drain to Source Diode Forward Current		-	-	-8	A
V_{SD}	Drain to Source Diode Forward Voltage	$V_{GS} = 0V, I_S = -2A$	-	-	-1.2	V

Note :

1. Repetitive Rating: Pulse Width Limited by Maximum Junction Temperature
2. Pulse Test: Pulse Width $\leq 300\mu s$, Duty Cycle $\leq 2\%$

Typical Performance Characteristics

Figure 1: Output Characteristics

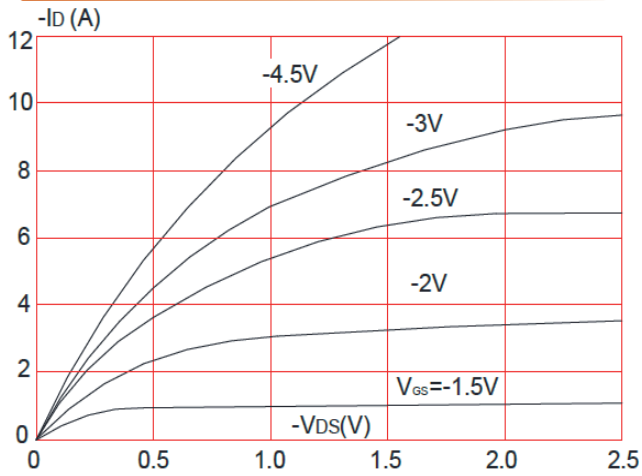

Figure 2: Typical Transfer Characteristics

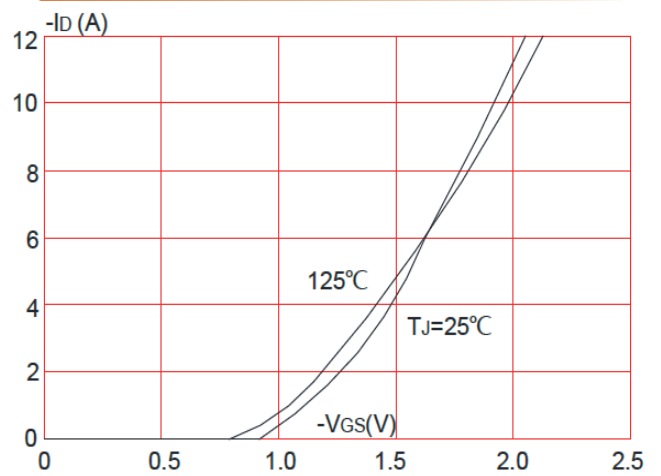

Figure 3: On-resistance vs. Drain Current

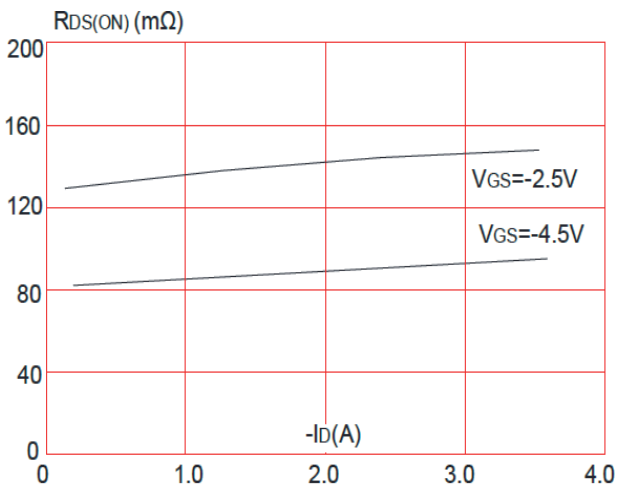

Figure 4: Body Diode Characteristics

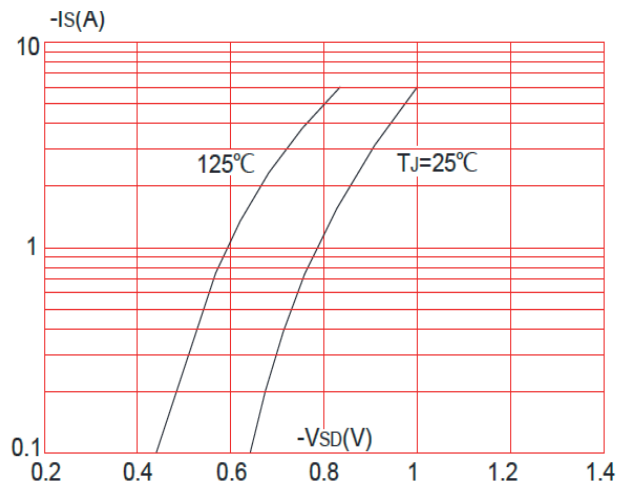

Figure 5: Gate Charge Characteristics

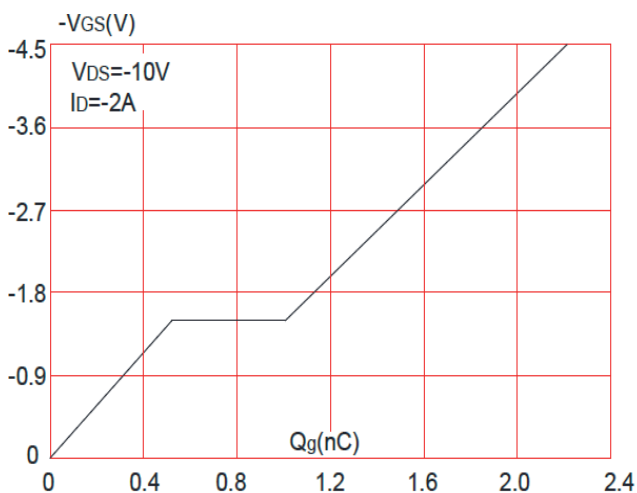
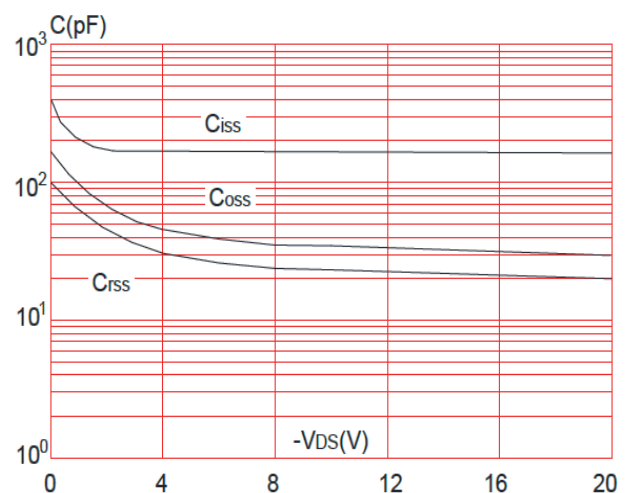

Figure 6: Capacitance Characteristics



Typical Performance Characteristics

Figure 7: Normalized Breakdown Voltage vs. Junction Temperature

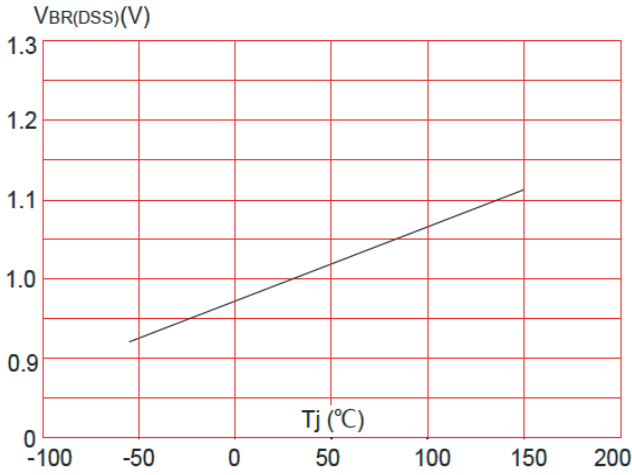

Figure 8: Normalized on Resistance vs. Junction Temperature

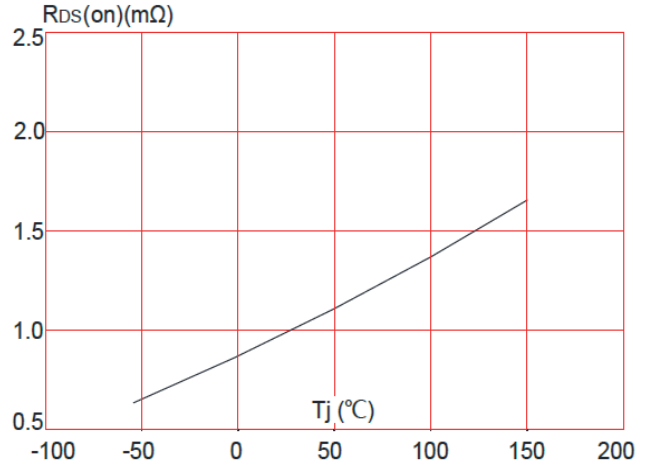

Figure 9: Maximum Safe Operating Area

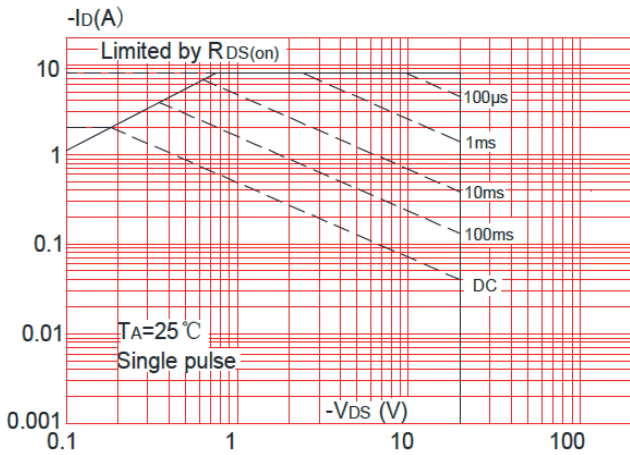

Figure 10: Maximum Continuous Drain Current vs. Ambient Temperature

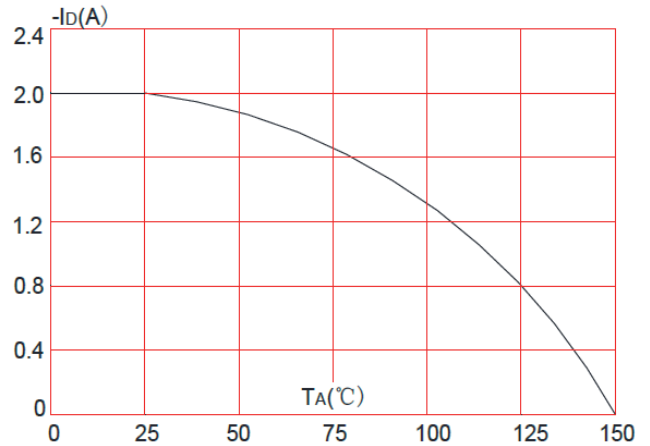
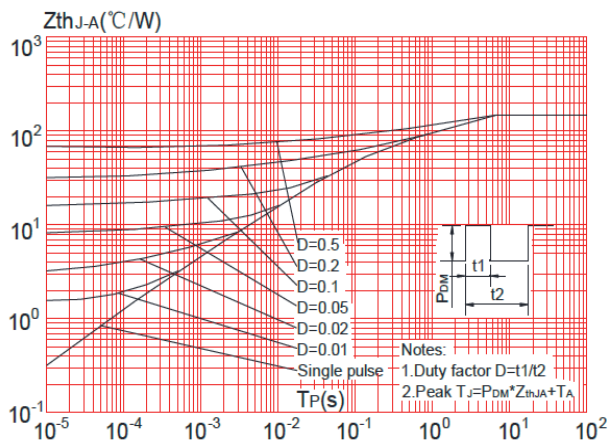
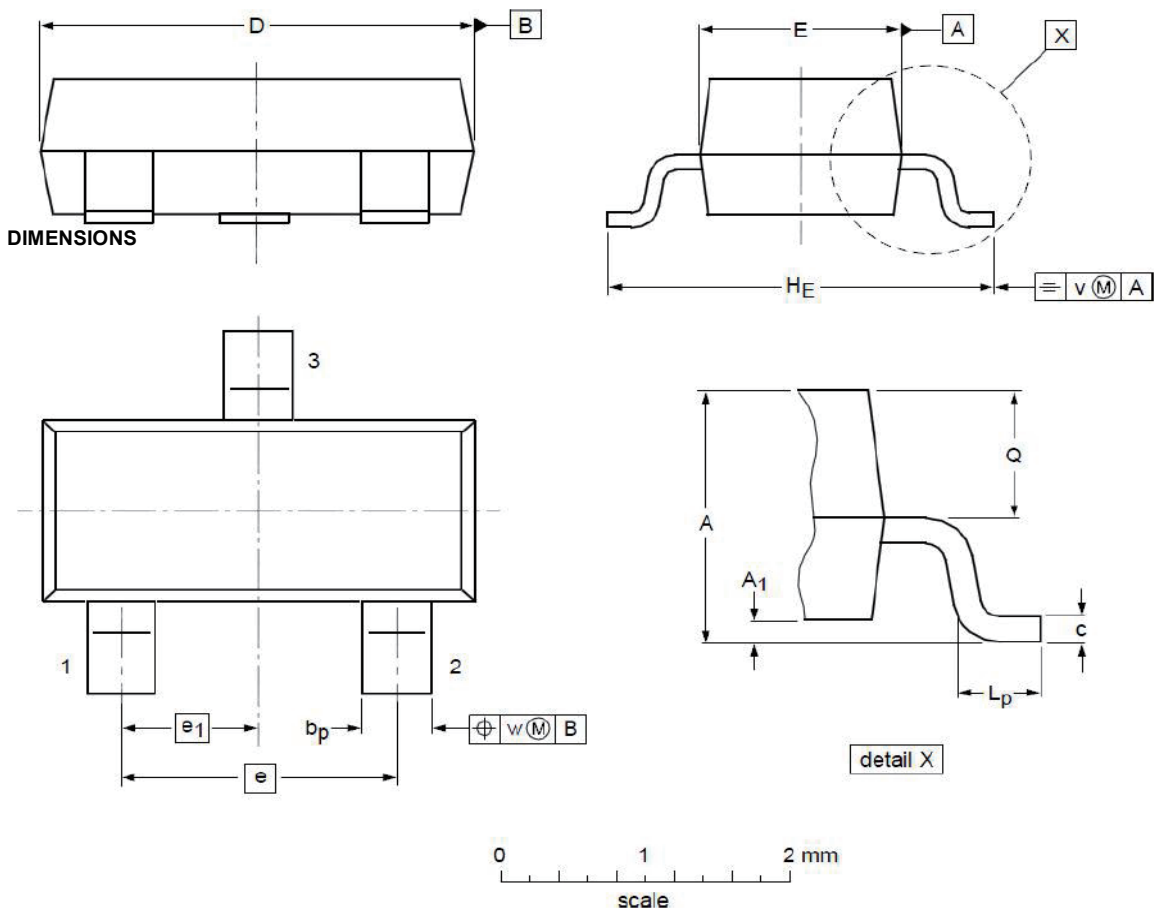

Figure 11: Maximum Effective Transient Thermal Impedance Junction to Ambient



SOT23 Mechanical tData



DIMENSIONS (unit : mm)

Symbol	Min	Typ	Max	Symbol	Min	Typ	Max
A	0.9	1.01	1.15	A ₁	0.01	0.05	0.1
b _p	0.3	0.42	0.5	c	0.08	0.13	0.15
D	2.8	2.92	3	E	1.2	1.33	1.4
e	--	1.9	--	e ₁	--	0.95	--
H _E	2.25	2.4	2.55	L _p	0.3	0.42	0.5
Q	0.45	0.49	0.55	v	--	0.2	--
w	--	0.1	--				

X-ON Electronics

Largest Supplier of Electrical and Electronic Components

Click to view similar products for [MOSFET](#) category:

Click to view products by [HL](#) manufacturer:

Other Similar products are found below :

[IRFD120](#) [JANTX2N5237](#) [2SK2267\(Q\)](#) [BUK455-60A/B](#) [TK100A10N1,S4X\(S](#) [MIC4420CM-TR](#) [VN1206L](#) [NDP4060](#) [SI4482DY](#)
[IRS2092STRPBF-EL](#) [IPS70R2K0CEAKMA1](#) [TK31J60W5,S1VQ\(O](#) [TK31J60W,S1VQ\(O](#) [TK16J60W,S1VQ\(O](#) [2SK2614\(TE16L1,Q\)](#)
[DMN1017UCP3-7](#) [EFC2J004NUZTDG](#) [P85W28HP2F-7071](#) [DMN1053UCP4-7](#) [NTE2384](#) [DMC2700UDMQ-7](#) [DMN2080UCB4-7](#)
[DMN61D9UWQ-13](#) [US6M2GTR](#) [DMN31D5UDJ-7](#) [DMP22D4UFO-7B](#) [IPS60R3K4CEAKMA1](#) [DMN1006UCA6-7](#) [DMN16M9UCA6-7](#)
[STF5N65M6](#) [IRF40H233XTMA1](#) [STU5N65M6](#) [DMN6022SSD-13](#) [DMN13M9UCA6-7](#) [DMTH10H4M6SPS-13](#) [IPS60R360PFD7SAKMA1](#)
[DMN2990UFB-7B](#) [SSM3K35CT,L3F](#) [IPLK60R1K0PFD7ATMA1](#) [2N7002W-G](#) [MCAC30N06Y-TP](#) [IPWS65R035CFD7AXKSA1](#)
[MCQ7328-TP](#) [SSM3J143TU,LXHF](#) [PJMF280N65E1_T0_00201](#) [PJMF380N65E1_T0_00201](#) [PJMF280N60E1_T0_00201](#)
[PJMF600N65E1_T0_00201](#) [PJMF900N65E1_T0_00201](#) [PJMF900N60E1_T0_00201](#)