

- ★ Green Device Available
- ★ Super Low Gate Charge
- ★ Excellent CdV/dt effect decline
- ★ Advanced high cell density Trench technology
- ★ 100% EAS Guaranteed

Product Summary

BVDSS	R _{DS(on)}	I _D
30V	8.5mΩ	13A

Description

The 4406 is the high cell density trenched N-ch MOSFETs, which provide excellent R_{DS(on)} and gate charge for most of the synchronous buck converter applications.

The 4406 meet the RoHS and Green Product, requirement 100% EAS guaranteed with full function reliability approved.

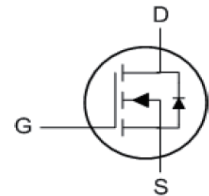
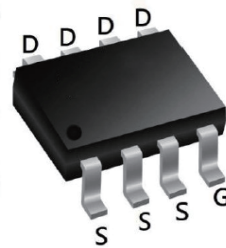
SOP8 Pin Configuration

Absolute Maximum Ratings

Symbol	Parameter	Rating	Units
V _{DS}	Drain-Source Voltage	30	V
V _{GS}	Gate-Source Voltage	±20	V
I _{D@TA=25°C}	Continuous Drain Current, V _{GS} @ 10V ¹	13	A
I _{D@TA=70°C}	Continuous Drain Current, V _{GS} @ 10V ¹	7.6	A
I _{DM}	Pulsed Drain Current ²	55	A
EAS	Single Pulse Avalanche Energy ³	33	mJ
I _{AS}	Avalanche Current	20	A
P _{D@TA=25°C}	Total Power Dissipation ⁴	5	W
T _{STG}	Storage Temperature Range	-55 to 150	°C
T _J	Operating Junction Temperature Range	-55 to 150	°C

Thermal Data

Symbol	Parameter	Typ.	Max.	Unit
R _{θJA}	Thermal Resistance Junction-Ambient ¹	---	85	°C/W
R _{θJC}	Thermal Resistance Junction-Case ¹	---	25	°C/W

Electrical Characteristics (T_J =25 °C unless otherwise specified)

Symbol	Parameter	Test Condition	Min.	Typ.	Max.	Units
Off Characteristic						
V _{(BR)DSS}	Drain-Source Breakdown Voltage	V _{GS} =0V, I _D =250μA	30	-	-	V
I _{DSS}	Zero Gate Voltage Drain Current	V _{DS} =30V, V _{GS} =0V,	-	-	1	μA
I _{GSS}	Gate to Body Leakage Current	V _{DS} =0V, V _{GS} =±20V	-	-	±100	nA
On Characteristics						
V _{GS(th)}	Gate Threshold Voltage	V _{DS} =V _{GS} , I _D =250μA	1	1.5	2.5	V
R _{DS(on)}	Static Drain-Source on-Resistance ^{note3}	V _{GS} =10V, I _D =13A	-	8.5	12	mΩ
		V _{GS} =4.5V, I _D =10A	-	13	18	
Dynamic Characteristics						
C _{iss}	Input Capacitance	V _{DS} =15V, V _{GS} =0V, f=1.0MHz	-	1011	-	pF
C _{oss}	Output Capacitance		-	142	-	pF
C _{rss}	Reverse Transfer Capacitance		-	119	-	pF
Q _g	Total Gate Charge	V _{DS} =15V, I _D =6A, V _{GS} =10V	-	19	-	nC
Q _{gs}	Gate-Source Charge		-	6.3	-	nC
Q _{gd}	Gate-Drain("Miller") Charge		-	4.5	-	nC
Switching Characteristics						
t _{d(on)}	Turn-on Delay Time	V _{DS} =15V, I _D =13A, R _{GEN} =3Ω, V _{GS} =10V	-	6	-	ns
t _r	Turn-on Rise Time		-	5	-	ns
t _{d(off)}	Turn-off Delay Time		-	25	-	ns
t _f	Turn-off Fall Time		-	7	-	ns
Drain-Source Diode Characteristics and Maximum Ratings						
I _S	Maximum Continuous Drain to Source Diode Forward Current		-	-	13	A
I _{SM}	Maximum Pulsed Drain to Source Diode Forward Current		-	-	52	A
V _{SD}	Drain to Source Diode Forward Voltage	V _{GS} =0V, I _S =13A	-	-	1.2	V
t _{rr}	Body Diode Reverse Recovery Time	I _F =13A, dI/dt=100A/μs	-	7	-	ns
Q _{rr}	Body Diode Reverse Recovery Charge		-	6.3	-	nC

Note :

- 1.Repetitive Rating: Pulse Width Limited by Maximum Junction Temperature
- 2.EAS condition: T_J=25°C, V_{GS}=15V, R_G=25Ω, L=0.5mH, I_{AS}=11.5A
- 3.Pulse Test: Pulse Width ≤300μs, Duty Cycle ≤0.5%

Typical Performance Characteristics

Figure 1: Output Characteristics

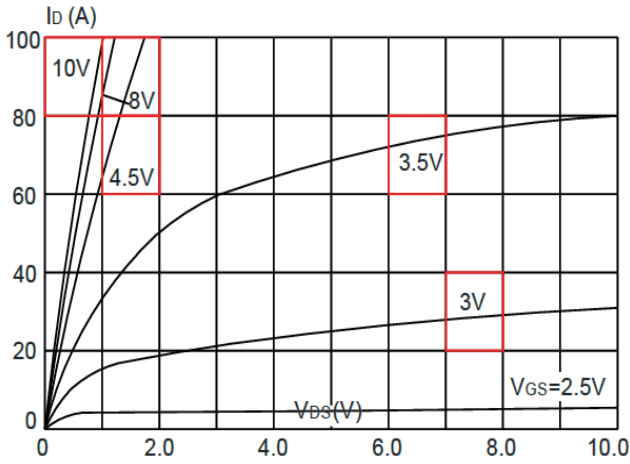

Figure 2: Typical Transfer Characteristics

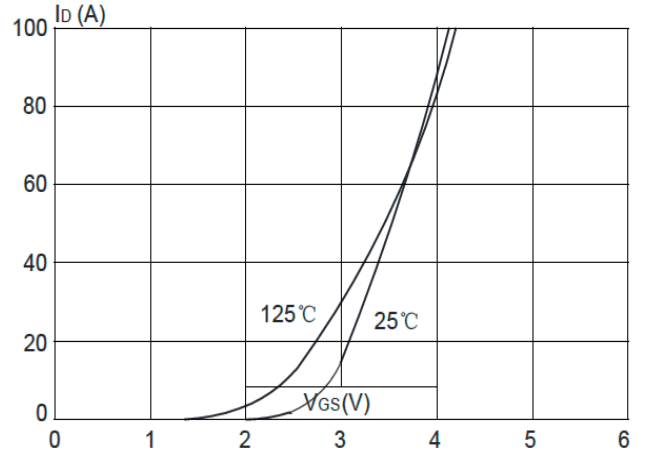

Figure 3: On-resistance vs. Drain Current

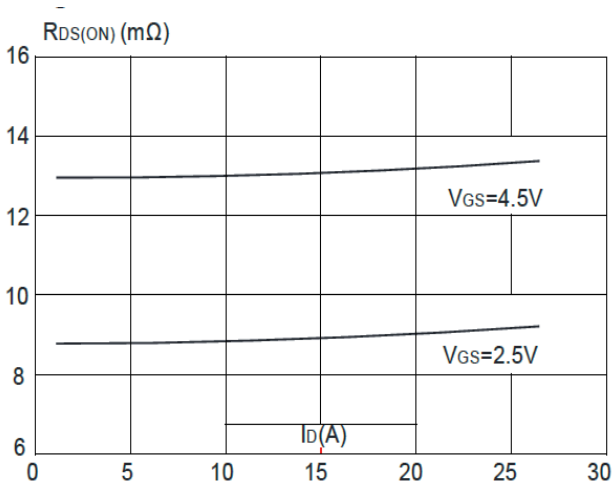

Figure 4: Body Diode Characteristics

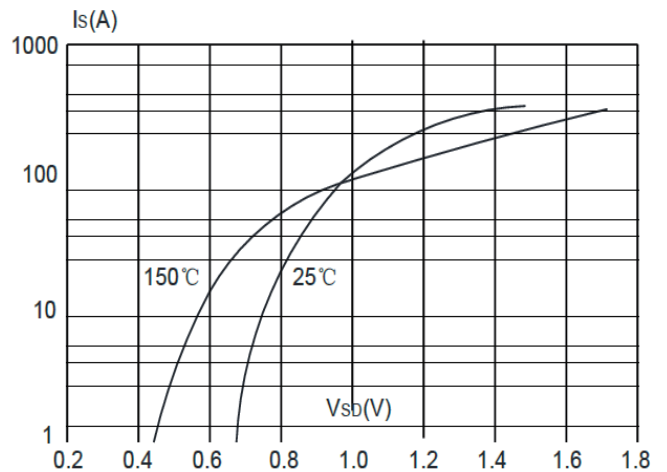

Figure 5: Gate Charge Characteristics

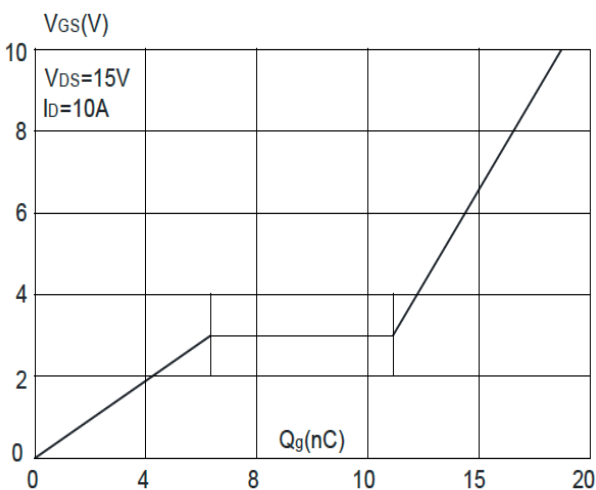
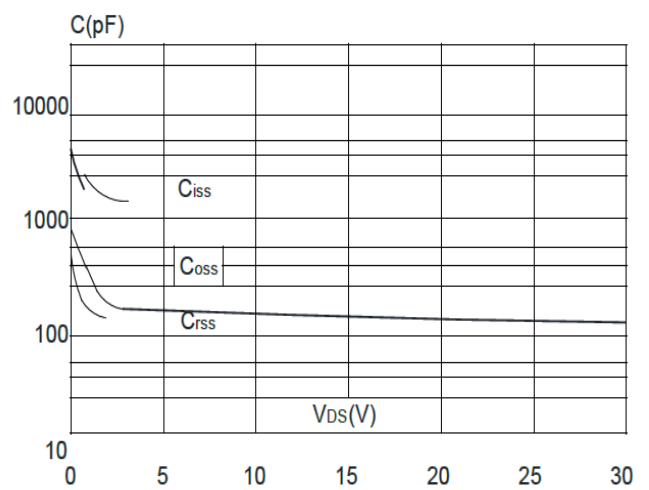

Figure 6: Capacitance Characteristics



Typical Performance Characteristics

Figure 7: Normalized Breakdown Voltage

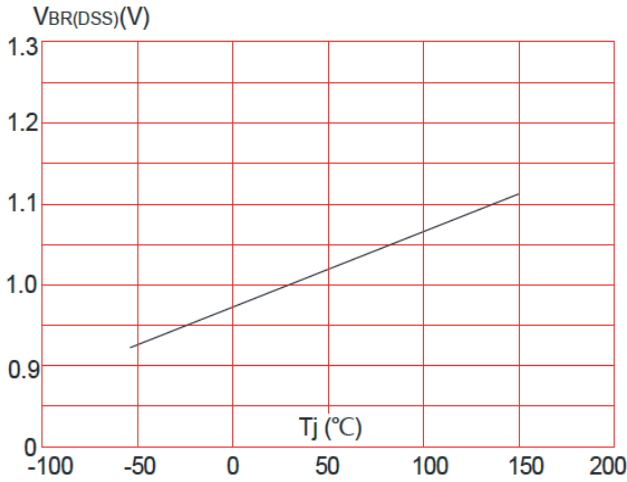

Figure 8: Normalized on Resistance vs. Junction Temperature

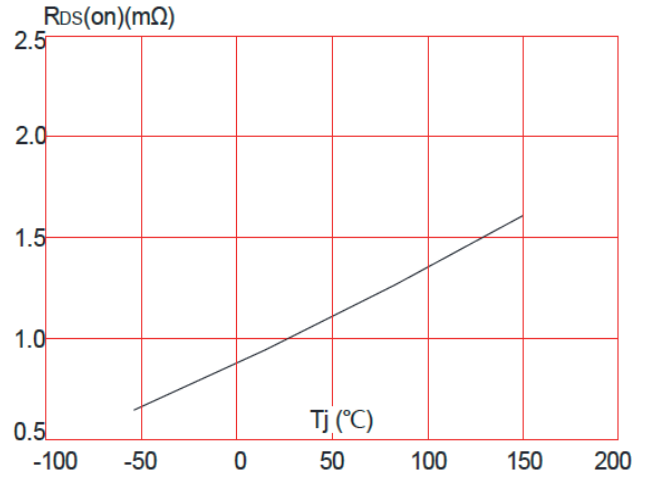

Figure 9: Maximum Safe Operating Area

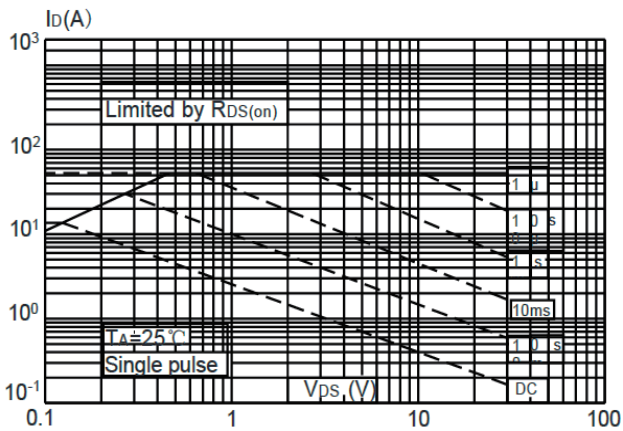

Figure 10: Maximum Continuous Drain Current vs. Ambient Temperature

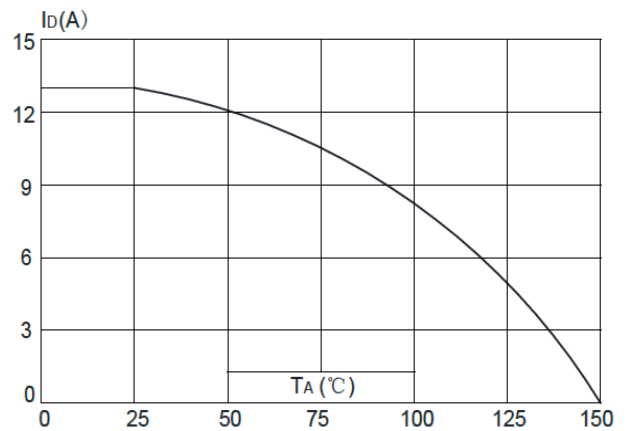
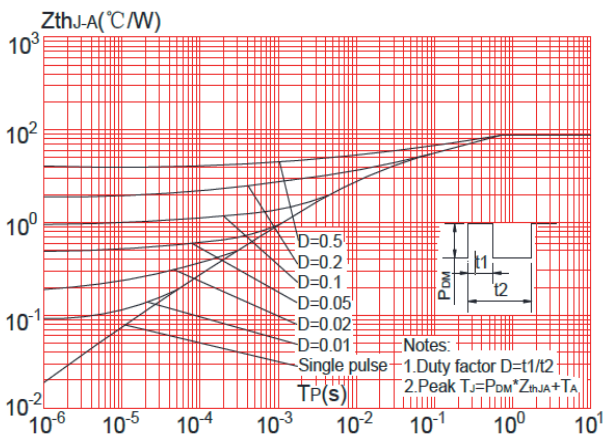
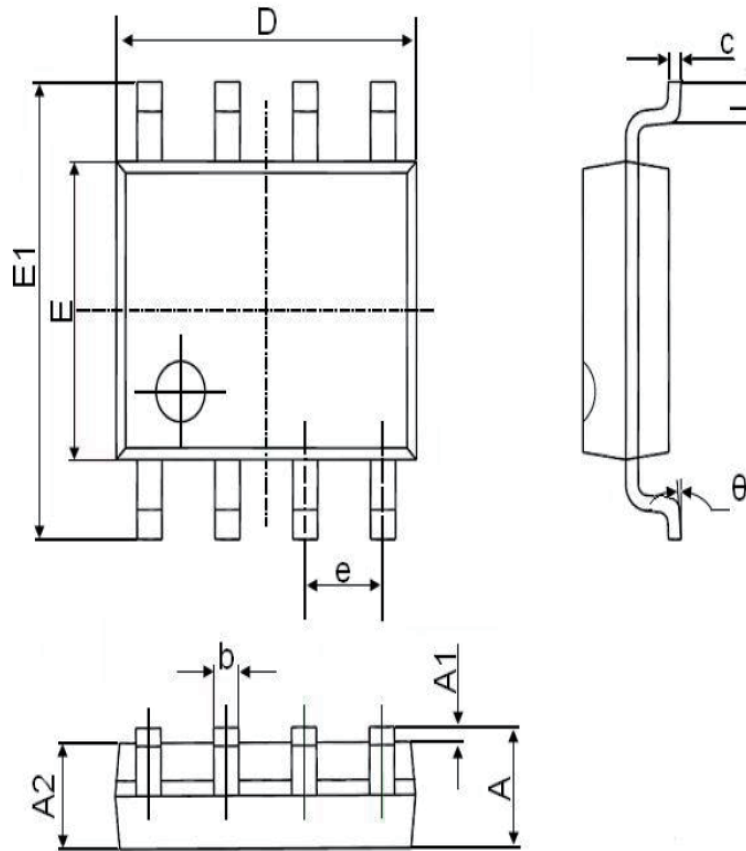

Figure 11: Maximum Effective Transient Thermal Impedance



SOP-8 Package Information



Symbol	Dimensions In Millimeters		Dimensions In Inches	
	Min.	Max.	Min.	Max.
A	1.35	1.75	0.053	0.069
A1	0.1	0.25	0.004	0.01
A2	1.35	1.55	0.053	0.061
b	0.33	0.51	0.013	0.02
c	0.17	0.25	0.006	0.01
D	4.7	5.1	0.185	0.2
E	3.8	4	0.15	0.157
E1	5.8	6.2	0.228	0.244
e	1.270(BSC)		0.050(BSC)	
L	0.4	1.27	0.016	0.05
θ	0°	8°	0°	8°

X-ON Electronics

Largest Supplier of Electrical and Electronic Components

Click to view similar products for [MOSFET](#) category:

Click to view products by [HL](#) manufacturer:

Other Similar products are found below :

[IRFD120](#) [JANTX2N5237](#) [2SK2267\(Q\)](#) [BUK455-60A/B](#) [TK100A10N1,S4X\(S](#) [MIC4420CM-TR](#) [VN1206L](#) [NDP4060](#) [SI4482DY](#)
[IRS2092STRPBF-EL](#) [IPS70R2K0CEAKMA1](#) [TK31J60W5,S1VQ\(O](#) [TK31J60W,S1VQ\(O](#) [TK16J60W,S1VQ\(O](#) [2SK2614\(TE16L1,Q\)](#)
[DMN1017UCP3-7](#) [EFC2J004NUZTDG](#) [P85W28HP2F-7071](#) [DMN1053UCP4-7](#) [NTE2384](#) [DMC2700UDMQ-7](#) [DMN2080UCB4-7](#)
[DMN61D9UWQ-13](#) [US6M2GTR](#) [DMN31D5UDJ-7](#) [DMP22D4UFO-7B](#) [IPS60R3K4CEAKMA1](#) [DMN1006UCA6-7](#) [DMN16M9UCA6-7](#)
[STF5N65M6](#) [IRF40H233XTMA1](#) [STU5N65M6](#) [DMN6022SSD-13](#) [DMN13M9UCA6-7](#) [DMTH10H4M6SPS-13](#) [IPS60R360PFD7SAKMA1](#)
[DMN2990UFB-7B](#) [SSM3K35CT,L3F](#) [IPLK60R1K0PFD7ATMA1](#) [2N7002W-G](#) [MCAC30N06Y-TP](#) [IPWS65R035CFD7AXKSA1](#)
[MCQ7328-TP](#) [SSM3J143TU,LXHF](#) [PJMF280N65E1_T0_00201](#) [PJMF380N65E1_T0_00201](#) [PJMF280N60E1_T0_00201](#)
[PJMF600N65E1_T0_00201](#) [PJMF900N65E1_T0_00201](#) [PJMF900N60E1_T0_00201](#)