

- ★ Green Device
- ★ Super Low Gate
- ★ Excellent CdV/dt effect decline
- ★ Advanced high cell density Trench technology
- ★ 100% EAS Guaranteed

Product Summary

BVDSS	RDS(on)	ID
60V	6mΩ	80A

Description

The 80N06F is the high cell density trenched N-ch MOSFETs, which provides excellent RDS(on) and gate charge for most of the synchronous buck converter applications. The 80N06F meets the RoHS and Green Product requirement 100% EAS guaranteed with full function reliability approved.

PDFN5X6 Pin Configuration

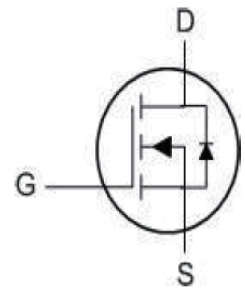
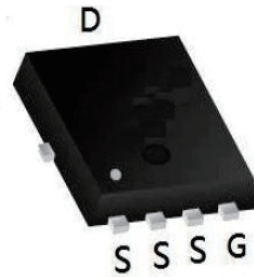

Absolute Maximum Ratings

Symbol	Parameter	Max.	Units	
V _{DSS}	Drain-Source Voltage	60	V	
V _{GSS}	Gate-Source Voltage	±25	V	
I _D	Continuous Drain Current	T _c = 25°C	80	A
		T _c = 100°C	52	A
I _{DM}	Pulsed Drain Current <small>note1</small>	320	A	
EAS	Single Pulsed Avalanche Energy <small>note2</small>	169	mJ	
P _D	Power Dissipation	T _c = 25°C	108	W
R _{θJC}	Thermal Resistance, Junction to Case	1.4	°C/W	
T _J , T _{STG}	Operating and Storage Temperature Range	-55 to +175	°C	

Electrical Characteristics ($T_J = 25^\circ\text{C}$ unless otherwise specified)

Symbol	Parameter	Test condition	Min.	Typ.	Max.	Units
Off Characteristic						
$V_{(BR)DSS}$	Drain-Source Breakdown Voltage	$V_{GS}=0V, I_D=250\mu A$	60	-	-	V
I_{DSS}	Zero Gate Voltage Drain Current	$V_{DS}=60V, V_{GS}=0V,$	-	-	1	μA
I_{GSS}	Gate to Body Leakage Current	$V_{DS}=0V, V_{GS}=\pm 20V$	-	-	± 100	nA
On Characteristics						
$V_{GS(th)}$	Gate Threshold Voltage	$V_{DS}=V_{GS}, I_D=250\mu A$	2	3	4	V
$R_{DS(on)}$	Static Drain-Source on-Resistance note3	$V_{GS}=10V, I_D = 30A$	-	6	7	m Ω
Dynamic Characteristics						
C_{iss}	Input Capacitance	$V_{DS}=30V, V_{GS}=0V,$ $f=1.0MHz$	-	4136	-	pF
C_{oss}	Output Capacitance		-	286	-	pF
C_{rss}	Reverse Transfer Capacitance		-	257	-	pF
Q_g	Total Gate Charge	$V_{DS}=30V, I_D=30A,$ $V_{GS}=10V$	-	90	-	nC
Q_{gs}	Gate-Source Charge		-	9	-	nC
Q_{gd}	Gate-Drain("Miller") Charge		-	18	-	nC
Switching Characteristics						
$t_{d(on)}$	Turn-on Delay Time	$V_{DS}=30V, I_D=30A,$ $R_G=1.8\Omega, V_{GS}=10V$	-	9	-	ns
t_r	Turn-on Rise Time		-	7	-	ns
$t_{d(off)}$	Turn-off Delay Time		-	40	-	ns
t_f	Turn-off Fall Time		-	15	-	ns
Drain-Source Diode Characteristics and Maximum Ratings						
I_S	Maximum Continuous Drain to Source Diode Forward Current		-	-	80	A
I_{SM}	Maximum Pulsed Drain to Source Diode Forward Current		-	-	320	A
V_{SD}	Drain to Source Diode Forward Voltage	$V_{GS}=0V, I_S=30A$	-	-	1.2	V
t_{rr}	Body Diode Reverse Recovery Time	$I_F=30A, dI/dt=100A/\mu s$	-	33	-	ns
Q_{rr}	Body Diode Reverse Recovery Charge		-	46	-	nC

Notes:

1. Repetitive Rating: Pulse Width Limited by Maximum Junction Temperature
2. EAS condition : $T_J=25^\circ\text{C}, V_{DD}=30V, V_G=10V, L=0.5mH, R_g=25\Omega, I_{AS}=26A$
3. Pulse Test: Pulse Width $\leq 300\mu s$, Duty Cycle $\leq 0.5\%$

Typical Electrical and Thermal Characteristics (Curves)

Figure 1: Output Characteristics

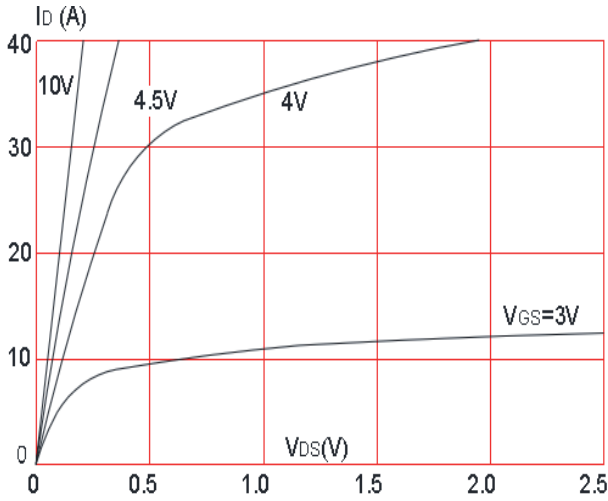

Figure 2: Typical Transfer Characteristics

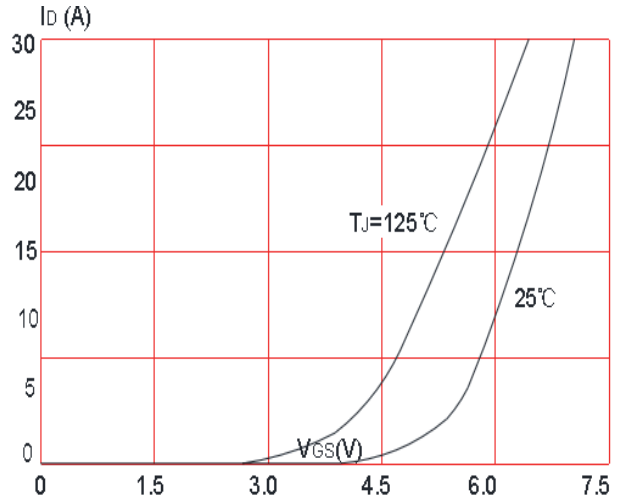

Figure 3: On-resistance vs. Drain Current

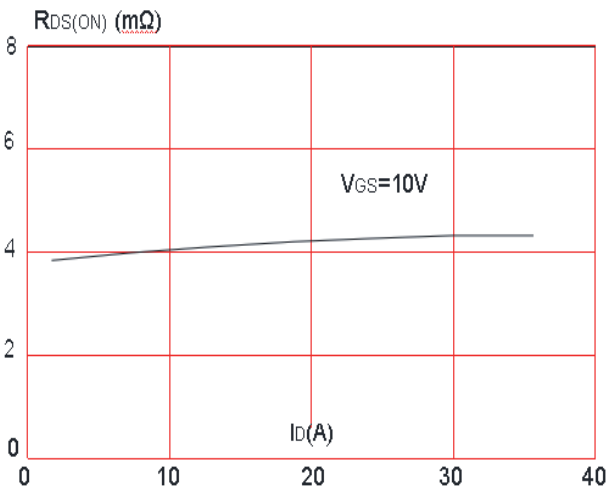

Figure 4: Body Diode Characteristics

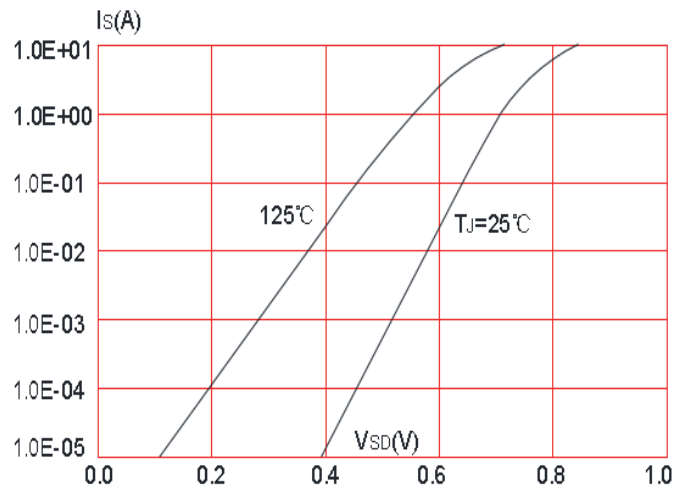

Figure 5: Gate Charge Characteristics

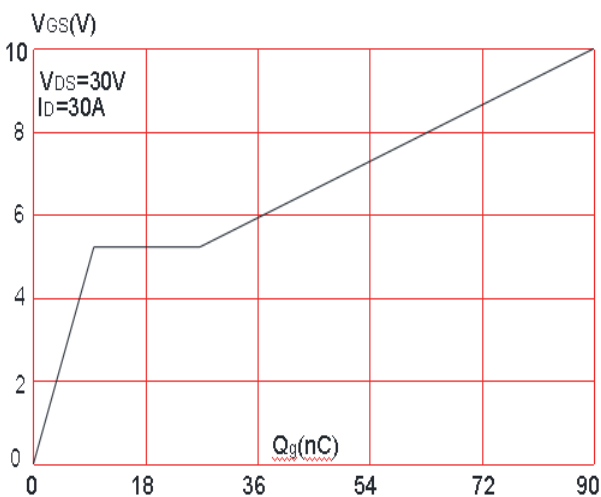
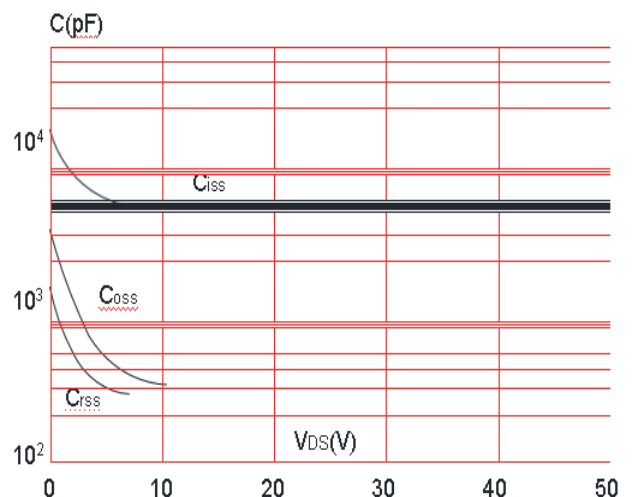

Figure 6: Capacitance Characteristics



Typical Performance Characteristics

Figure 7: Normalized Breakdown Voltage

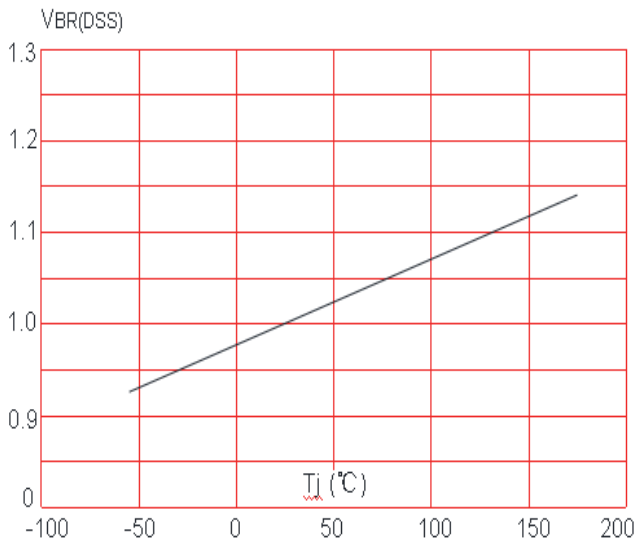

Figure 8: Normalized on Resistance vs. Junction Temperature

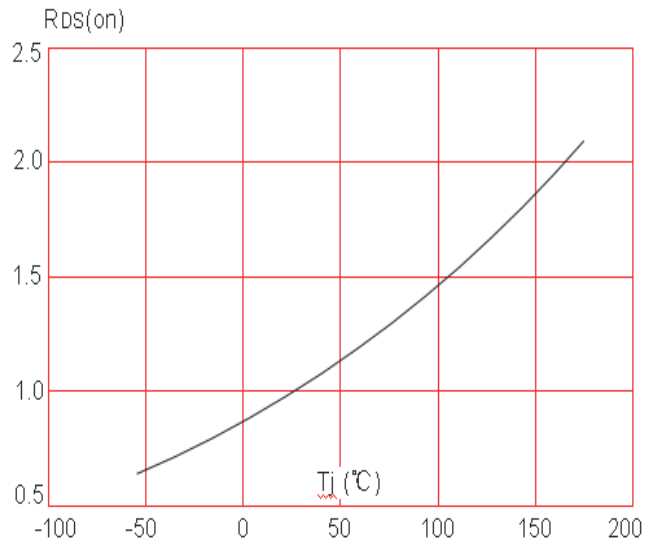

Figure 9: Maximum Safe Operating Area

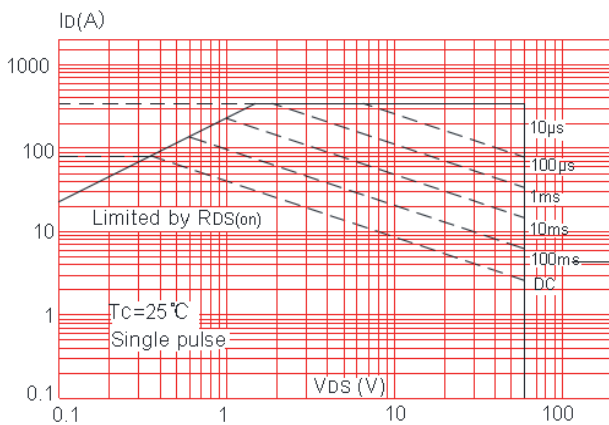

Figure 11: Maximum Continuous Drain Current vs. Temperature

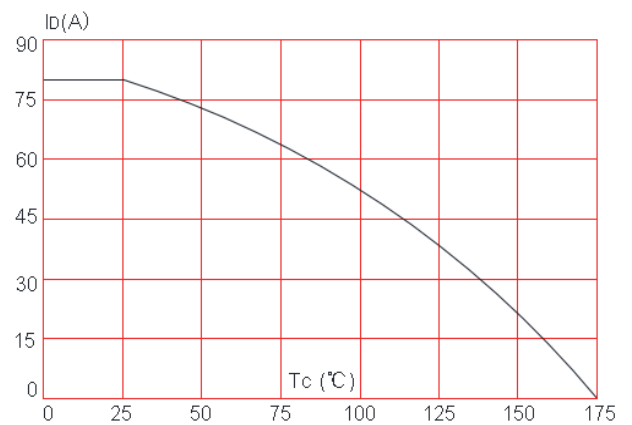
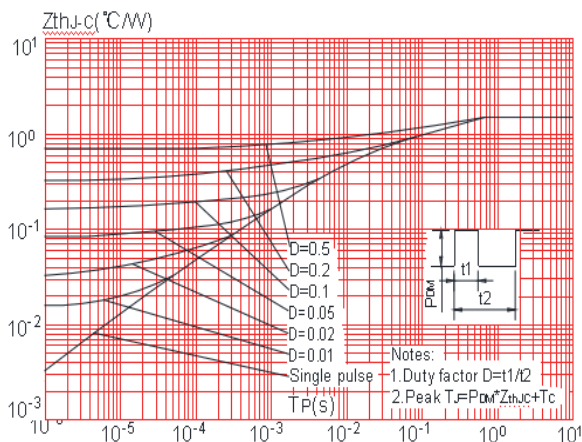
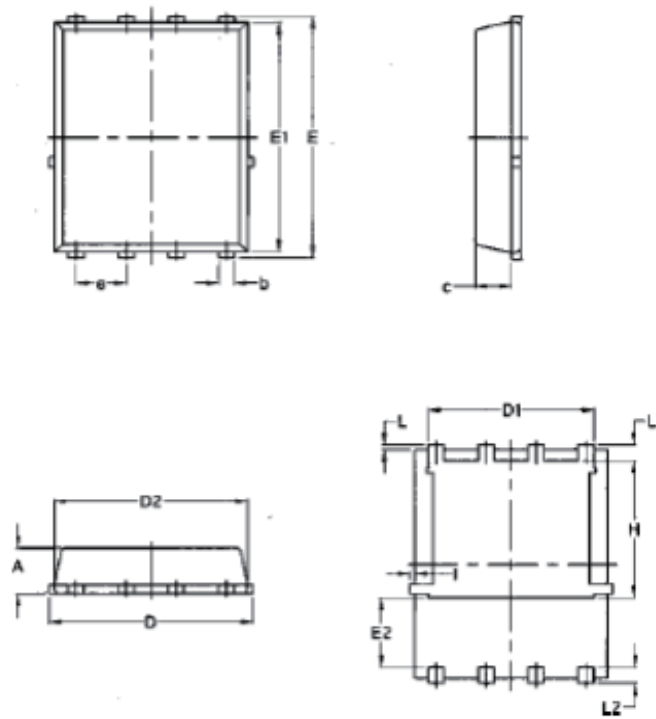

Figure 10: Maximum Effective Transient Thermal Impedance



Package Mechanical Data-DFN5*6-8L-JQ Single



Symbol	Common			
	mm		Inch	
	Min	Max	Min	Max
A	1.03	1.17	0.0406	0.0461
b	0.34	0.48	0.0134	0.0189
c	0.824	0.0970	0.0324	0.082
D	4.80	5.40	0.1890	0.2126
D1	4.11	4.31	0.1618	0.1697
D2	4.80	5.00	0.1890	0.1969
E	5.95	6.15	0.2343	0.2421
E1	5.65	5.85	0.2224	0.2303
E2	1.60	/	0.0630	/
e	1.27 BSC		0.05 BSC	
L	0.05	0.25	0.0020	0.0098
L1	0.38	0.50	0.0150	0.0197
L2	0.38	0.50	0.0150	0.0197
H	3.30	3.50	0.1299	0.1378
l	/	0.18	/	0.0070

X-ON Electronics

Largest Supplier of Electrical and Electronic Components

Click to view similar products for [MOSFET](#) category:

Click to view products by [HL](#) manufacturer:

Other Similar products are found below :

[IRFD120](#) [JANTX2N5237](#) [2SK2267\(Q\)](#) [BUK455-60A/B](#) [TK100A10N1,S4X\(S](#) [MIC4420CM-TR](#) [VN1206L](#) [NDP4060](#) [SI4482DY](#)
[IRS2092STRPBF-EL](#) [IPS70R2K0CEAKMA1](#) [TK31J60W5,S1VQ\(O](#) [TK31J60W,S1VQ\(O](#) [TK16J60W,S1VQ\(O](#) [2SK2614\(TE16L1,Q\)](#)
[DMN1017UCP3-7](#) [EFC2J004NUZTDG](#) [P85W28HP2F-7071](#) [DMN1053UCP4-7](#) [NTE2384](#) [DMC2700UDMQ-7](#) [DMN2080UCB4-7](#)
[DMN61D9UWQ-13](#) [US6M2GTR](#) [DMN31D5UDJ-7](#) [DMP22D4UFO-7B](#) [IPS60R3K4CEAKMA1](#) [DMN1006UCA6-7](#) [DMN16M9UCA6-7](#)
[STF5N65M6](#) [IRF40H233XTMA1](#) [STU5N65M6](#) [DMN6022SSD-13](#) [DMN13M9UCA6-7](#) [DMTH10H4M6SPS-13](#) [IPS60R360PFD7SAKMA1](#)
[DMN2990UFB-7B](#) [SSM3K35CT,L3F](#) [IPLK60R1K0PFD7ATMA1](#) [2N7002W-G](#) [MCAC30N06Y-TP](#) [IPWS65R035CFD7AXKSA1](#)
[MCQ7328-TP](#) [SSM3J143TU,LXHF](#) [DMN12M3UCA6-7](#) [PJMF280N65E1_T0_00201](#) [PJMF380N65E1_T0_00201](#)
[PJMF280N60E1_T0_00201](#) [PJMF600N65E1_T0_00201](#) [PJMF900N65E1_T0_00201](#)