

- ★ Green Device Available
- ★ Super Low Gate Charge
- ★ Excellent CdV/dt effect decline
- ★ Advanced high cell density Trench technology

Product Summary

BVDSS	R _{DS(on)}	I _D
20V	14mΩ	7A

Description

The 8810 is the low R_{DS(on)} trenched N-CH MOSFETs with robust ESD protection. This product is suitable for Lithium-ion battery pack applications. The 8810 meet the RoHS and Green Product requirement with full function reliability approved.

SOT23-6L Pin Configuration

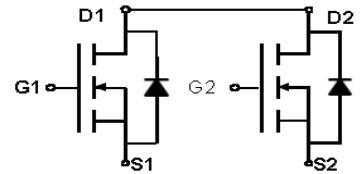
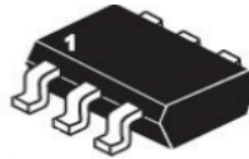

Absolute Maximum Ratings (TA=25°C unless otherwise noted)

Symbol	Parameter	Limit	Unit
V _{DS}	Drain-Source Voltage	20	V
V _{GS}	Gate-Source Voltage	±10	V
I _D	Drain Current-Continuous	7	A
I _{DM}	Drain Current-Pulsed (Note 1)	25	A
P _D	Maximum Power Dissipation	1.25	W
T _J , T _{STG}	Operating Junction and Storage Temperature Range	-55 To 150	°C

Package Marking and Ordering Information

Device Marking	Device	Device Package	Reel Size	Tape width	Quantity
8810	8810	SOT23-6L	Ø180mm	8mm	3000 units

Thermal Data

R _{θJA}	Thermal Resistance, Junction-to-Ambient (Note 2)	100	°C/W
------------------	--	-----	------

Electrical Characteristics ($T_J = 25^\circ\text{C}$ unless otherwise specified)

Symbol	Parameter	Conditions	Min.	Typ.	Max.	Unit
I_{GSS}	Gate-Body Leakage Current	$V_{GS} = \pm 12\text{V}, V_{DS} = 0\text{V}$	-	-	± 100	nA
On Characteristics ^(Note 3)						
$V_{GS(th)}$	Gate Threshold Voltage	$V_{DS} = V_{GS}, I_D = 250\mu\text{A}$	0.5	0.7	1.2	V
$R_{DS(ON)}$	Drain-Source On-State Resistance	$V_{GS} = 4.5\text{V}, I_D = 4.5\text{A}$	-	14	20	m Ω
		$V_{GS} = 2.5\text{V}, I_D = 3.5\text{A}$	-	19	25	
g_{FS}	Forward Transconductance	$V_{DS} = 5\text{V}, I_D = 4.5\text{A}$	-	10	-	S
Dynamic Characteristics ^(Note 4)						
C_{ISS}	Input Capacitance	$V_{DS} = 10\text{V}, V_{GS} = 0\text{V}, F = 1.0\text{MHz}$	-	900	-	PF
C_{OSS}	Output Capacitance		-	220	-	
C_{RSS}	Reverse Transfer Capacitance		-	100	-	
Switching Characteristics ^(Note 4)						
$t_{d(on)}$	Turn-on Delay Time	$V_{DD} = 10\text{V}, I_D = 1\text{A}, V_{GS} = 4.5\text{V}, R_{GEN} = 6\Omega$	-	10	20	nS
t_r	Turn-on Rise Time		-	11	25	
$t_{d(off)}$	Turn-Off Delay Time		-	35	70	
t_f	Turn-Off Fall Time		-	30	60	
Q_g	Total Gate Charge	$V_{DS} = 10\text{V}, I_D = 6\text{A}, V_{GS} = 4.5\text{V}$	-	12	15	nC
Q_{gs}	Gate-Source Charge		-	2.3	-	
Q_{gd}	Gate-Drain Charge		-	1	-	
Drain-Source Diode Characteristics						
V_{SD}	Diode Forward Voltage ^(Note 3)	$V_{GS} = 0\text{V}, I_S = 1.7\text{A}$	-	0.75	1.2	V
I_S	Diode Forward Current ^(Note 2)		-	-	6.5	A

Typical Electrical and Thermal Characteristics (Curves)

Figure 1: Switching Test Circuit

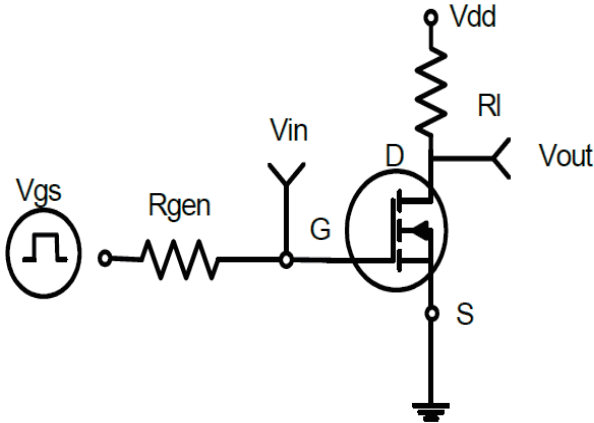

Figure 2: Switching Waveforms

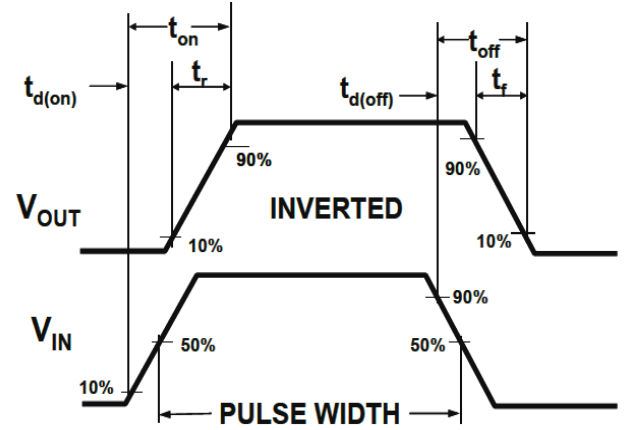

Figure 3: Power Dissipation

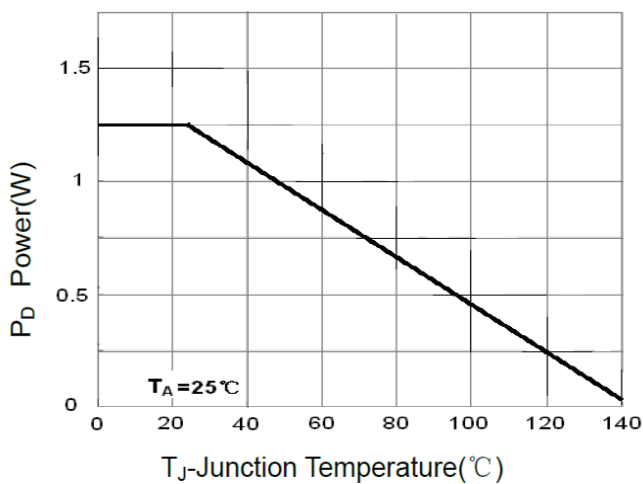

Figure 4: Drain Current

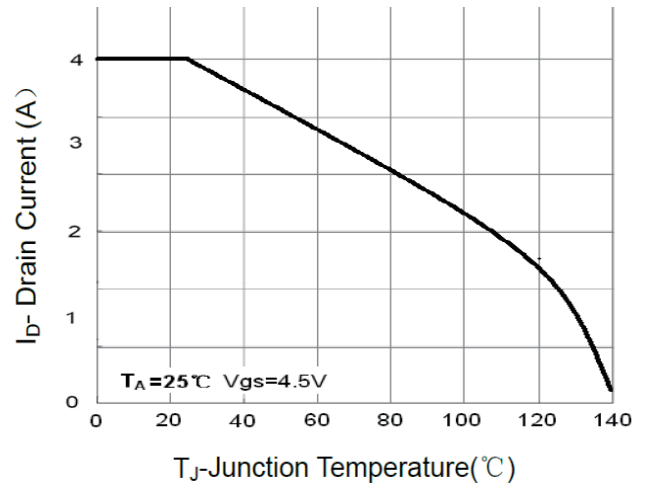

Figure 5: Output Characteristics

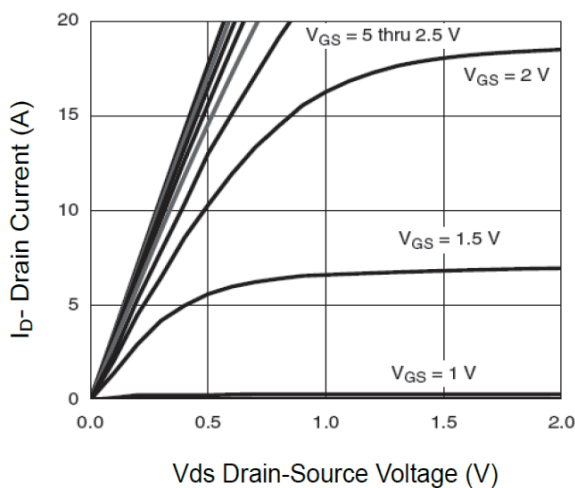
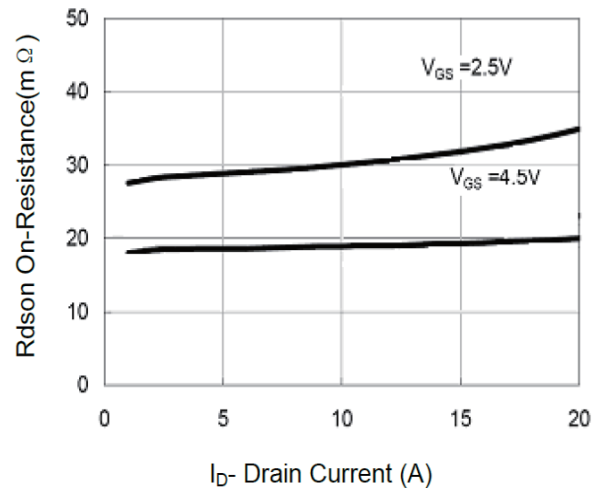

Figure 6: Drain-Source On-Resistance



Typical Performance Characteristics

Figure 7: Transfer Characteristics

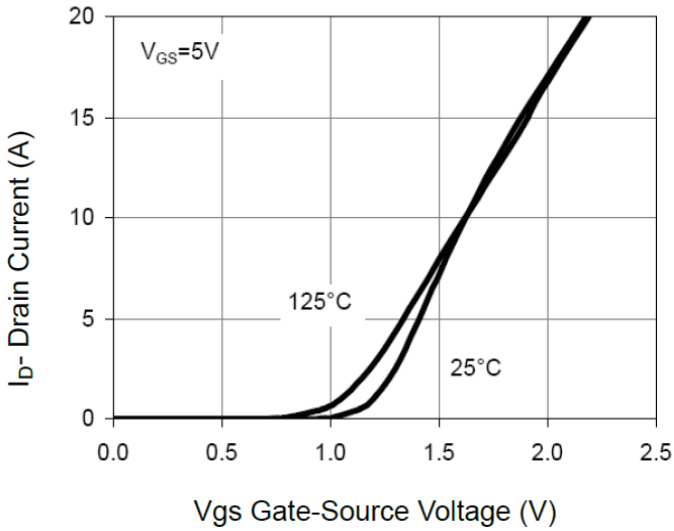

Figure 8: Drain-Source On-Resistance

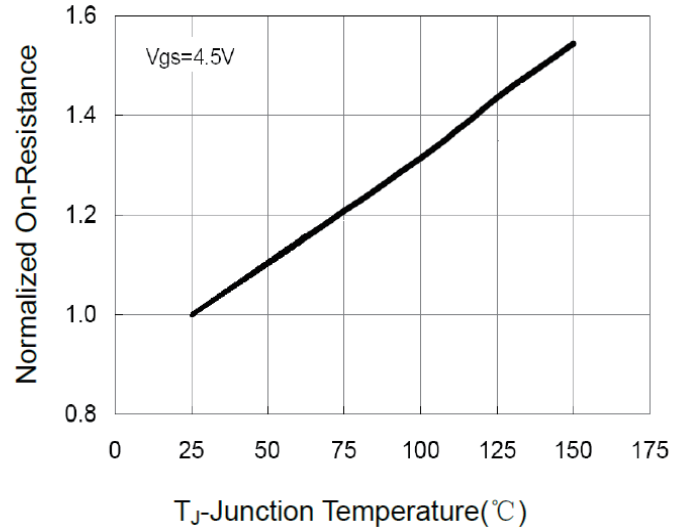

Figure 9: R_{dson} vs V_{gs}

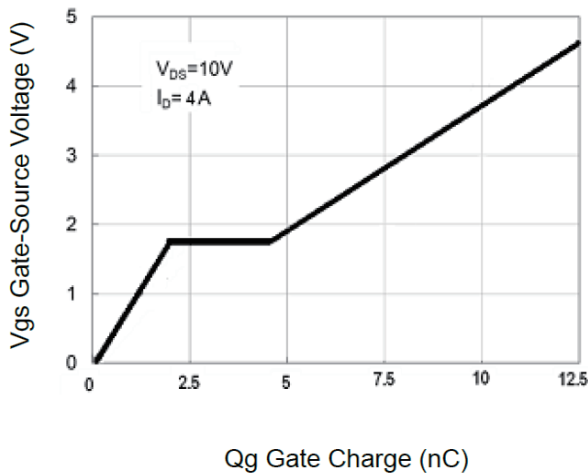

Figure 10: Capacitance vs V_d

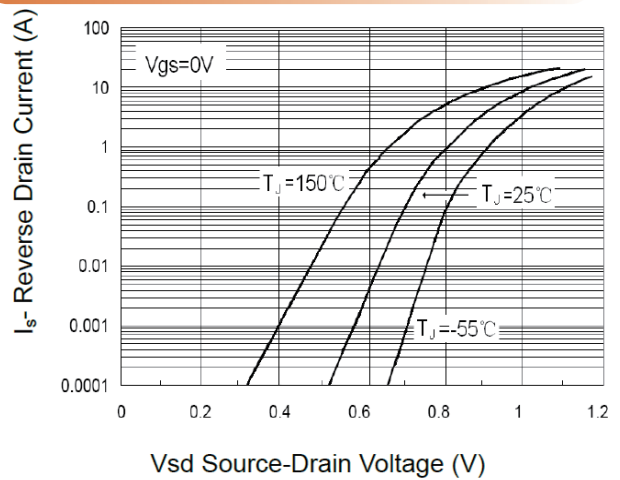

Figure 11: Gate Charge

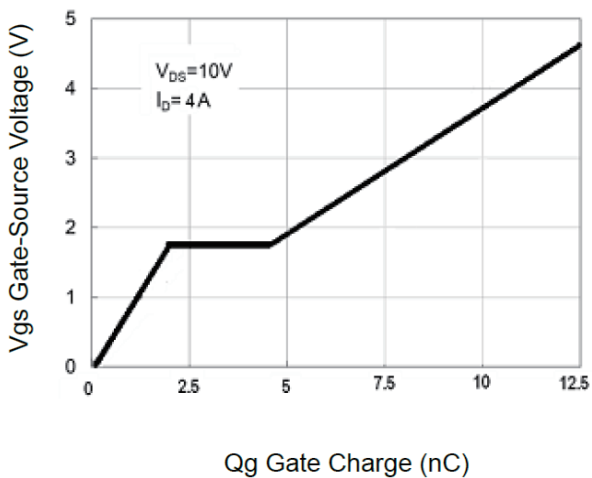
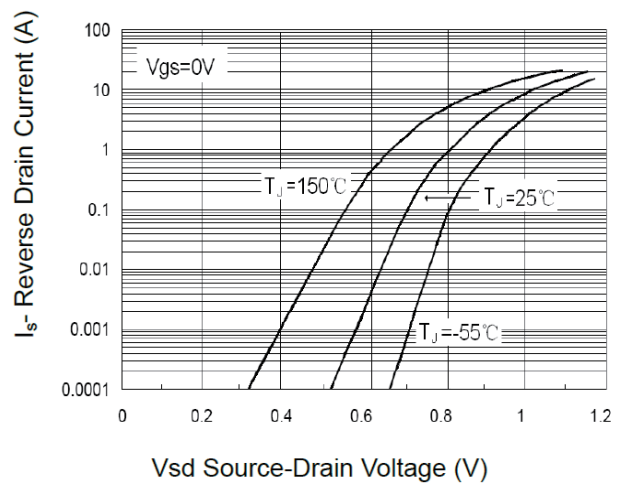

Figure 12: Source- Drain Diode Forward



Typical Performance Characteristics

Figure 13: Safe Operation Area

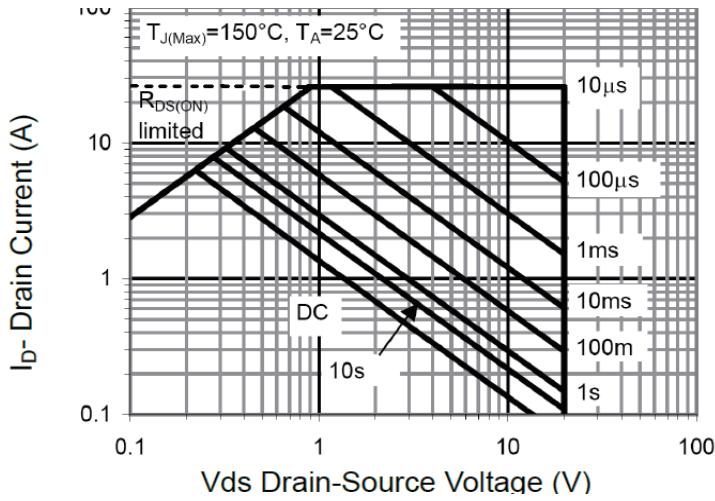
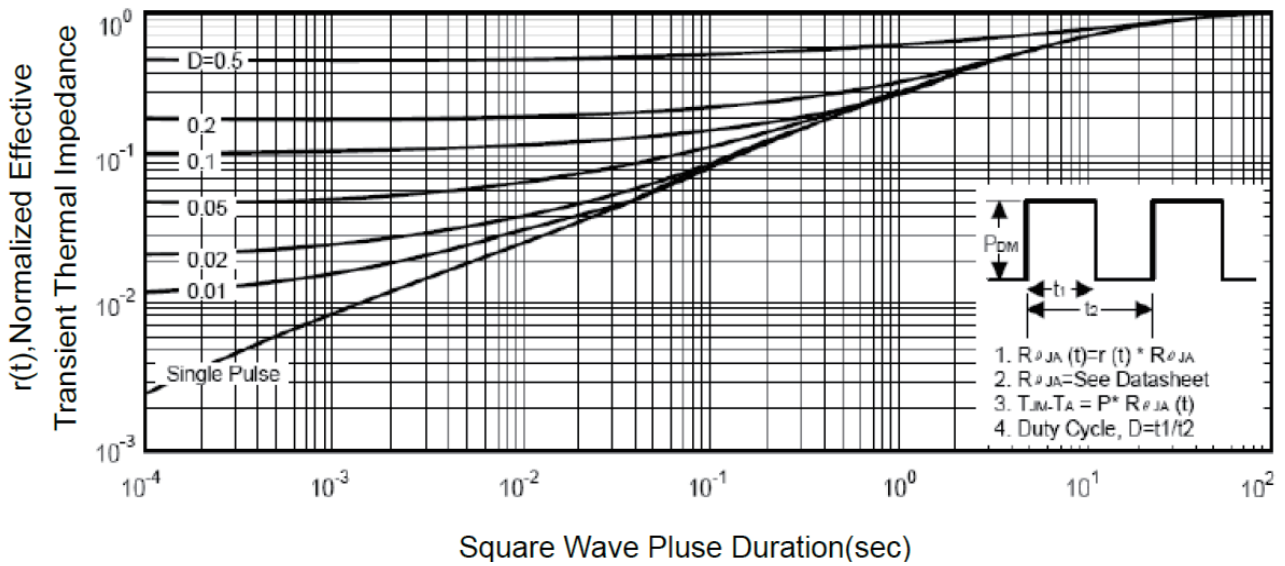
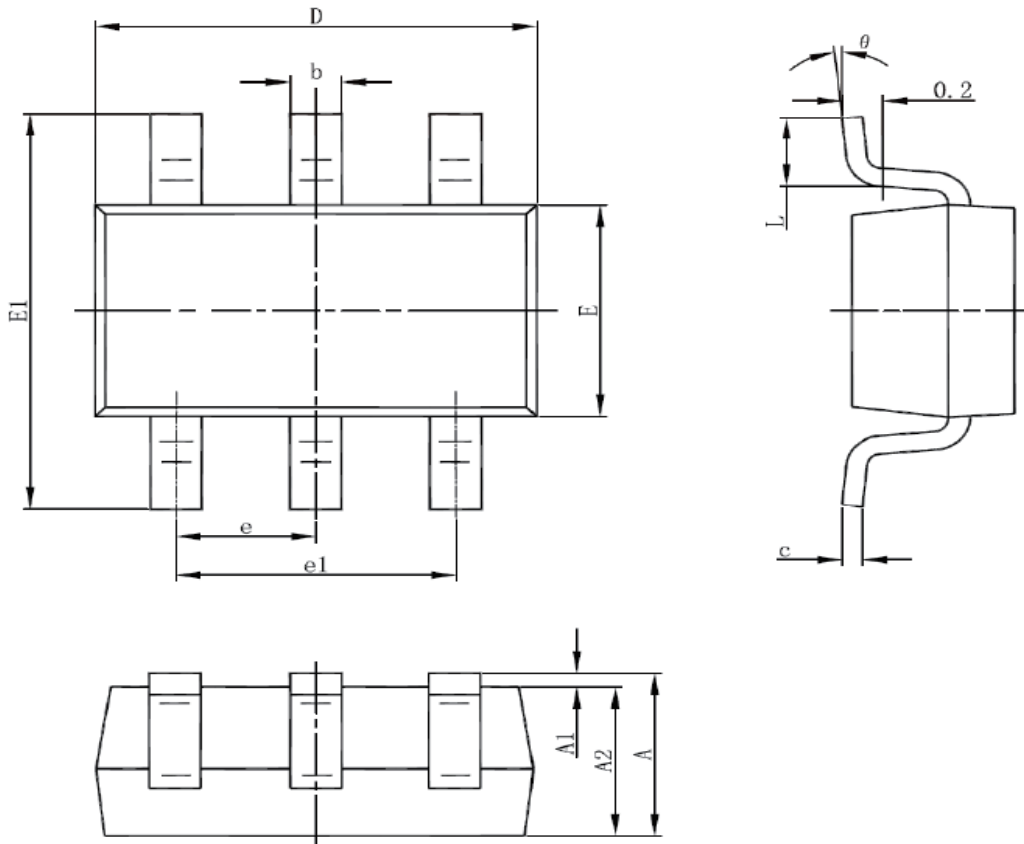

Figure 14: Normalized Maximum Transient Thermal Impedance



SOT23-6L Package Information



Symbol	Dimensions In Millimeters		Dimensions In Inches	
	Min	Max	Min	Max
A	1.050	1.250	0.041	0.049
A1	0.000	0.100	0.000	0.004
A2	1.050	1.150	0.041	0.045
b	0.300	0.500	0.012	0.020
c	0.100	0.200	0.004	0.008
D	2.820	3.020	0.111	0.119
E	1.500	1.700	0.059	0.067
E1	2.650	2.950	0.104	0.116
e	0.950(BSC)		0.037(BSC)	
e1	1.800	2.000	0.071	0.079
L	0.300	0.600	0.012	0.024
θ	0°	8°	0°	8°

X-ON Electronics

Largest Supplier of Electrical and Electronic Components

Click to view similar products for [MOSFET](#) category:

Click to view products by [HL](#) manufacturer:

Other Similar products are found below :

[IRFD120](#) [JANTX2N5237](#) [BUK455-60A/B](#) [MIC4420CM-TR](#) [VN1206L](#) [NDP4060](#) [SI4482DY](#) [IPS70R2K0CEAKMA1](#) [SQD23N06-31L-GE3](#)
[TK16J60W,S1VQ\(O](#) [2SK2614\(TE16L1,Q\)](#) [DMN1017UCP3-7](#) [DMN1053UCP4-7](#) [SQJ469EP-T1-GE3](#) [NTE2384](#) [DMC2700UDMQ-7](#)
[DMN2080UCB4-7](#) [DMN61D9UWQ-13](#) [US6M2GTR](#) [DMN31D5UDJ-7](#) [DMP22D4UFO-7B](#) [DMN1006UCA6-7](#) [DMN16M9UCA6-7](#)
[STF5N65M6](#) [IRF40H233XTMA1](#) [STU5N65M6](#) [DMN6022SSD-13](#) [DMN13M9UCA6-7](#) [DMTH10H4M6SPS-13](#) [DMN2990UFB-7B](#)
[IPB80P04P405ATMA2](#) [2N7002W-G](#) [MCAC30N06Y-TP](#) [MCQ7328-TP](#) [NTMC083NP10M5L](#) [BXP7N65D](#) [BXP4N65F](#) [AOL1454G](#)
[WMJ80N60C4](#) [BXP2N20L](#) [BXP2N65D](#) [BXT1150N10J](#) [BXT1700P06M](#) [TSM60NB380CP](#) [ROG](#) [RQ7L055BGTGR](#) [DMNH15H110SK3-13](#)
[SLF10N65ABV2](#) [BSO203SP](#) [BSO211P](#) [IPA60R230P6](#)