

## Feature

- ★ Super Low Gate Charge
- ★ Green Device Available
- ★ Excellent CdV/dt effect decline
- ★ Advanced high cell density Trench technology

## Product Summary

RoHS

BVDSS	RDSON	ID
100V	95mΩ	12A

## Description

The S12N10 is the high cell density trenched N ch MOSFETs, which provide excellent RDSON and gate charge for most of the synchronous buck converter applications.

The S12N10 meet the RoHS and Green Product requirement with full function reliability approved.

## TO252 Pin Configuration

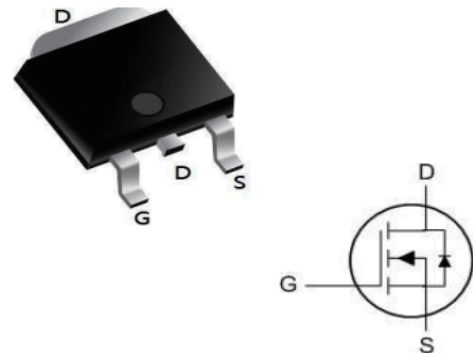

## Absolute Maximum Ratings

Symbol	Parameter	Value	Unit
$V_{DS}$	Drain-Source Voltage	100	V
$V_{GS}$	Gate-Source Voltage	$\pm 20$	V
$I_D@T_A=25^\circ C$	Continuous Drain Current, $V_{GS}@ 10V^1$	12	A
$I_D@T_A=70^\circ C$	Continuous Drain Current, $V_{GS}@ 10V^1$	3.2	A
$I_{DM}$	Pulsed Drain Current $^2$	11	A
$P_D@T_A=25^\circ C$	Total Power Dissipation $^3$	1	W
$T_{STG}$	Storage Temperature Range	-55 to 150	$^\circ C$
$T_J$	Operating Junction Temperature Range	-55 to 150	$^\circ C$

## Thermal Data

Symbol	Parameter	Value	Unit
$R_{\theta JA}$	Thermal Resistance Junction-ambient $^1$	125	$^\circ C/W$
$R_{\theta JC}$	Thermal Resistance Junction-Case $^1$	80	$^\circ C/W$

Electrical Characteristics ( $T_J = 25^\circ\text{C}$  unless otherwise specified)

Symbol	Parameter	Test condition	Min.	Typ.	Max.	Units
<b>Off Characteristic</b>						
$V_{(BR)DSS}$	Drain-Source Breakdown Voltage	$V_{GS} = 0V, I_D = 250\mu A$	100	110	-	V
$I_{DSS}$	Zero Gate Voltage Drain Current	$V_{DS} = 100V, V_{GS} = 0V$	-	-	1	$\mu A$
$I_{GSS}$	Gate to Body Leakage Current	$V_{DS} = 0V, V_{GS} = \pm 20V$	-	-	$\pm 100$	nA
<b>On Characteristics</b> <small>note3</small>						
$V_{GS(th)}$	Gate Threshold Voltage	$V_{DS} = V_{GS}, I_D = 250\mu A$	1	1.8	3	V
$R_{DS(on)}$	Static Drain-Source On-Resistance <small>note2</small>	$V_{GS} = 10V, I_D = 3A$	-	95	140	m $\Omega$
<b>Dynamic Characteristics</b> <small>note4</small>						
$C_{iss}$	Input Capacitance	$V_{DS} = 50V, V_{GS} = 0V, f = 1.0MHz$	-	196	-	pF
$C_{oss}$	Output Capacitance		-	25.9	-	pF
$C_{rss}$	Reverse Transfer Capacitance		-	21.4	-	pF
$Q_g$	Total Gate Charge	$V_{DS} = 50V, I_D = 3A, V_{GS} = 10V$	-	4.3	-	nC
$Q_{gs}$	Gate-Source Charge		-	3.5	-	nC
$Q_{gd}$	Gate-Drain ("Miller") Charge		-	3.1	-	nC
<b>Switching Characteristics</b> <small>note4</small>						
$t_{d(on)}$	Turn-On Delay Time	$V_{DD} = 50V, I_{DS} = 3A, R_G = 2\Omega, V_{GEN} = 10V$	-	14.7	-	ns
$t_r$	Turn-On Rise Time		-	3.5	-	ns
$t_{d(off)}$	Turn-Off Delay Time		-	20.9	-	ns
$t_f$	Turn-Off Fall Time		-	2.7	-	ns
<b>Drain-Source Diode Characteristics and Maximum Ratings</b>						
$I_S$	Maximum Continuous Drain to Source Diode Forward Current <small>note2</small>		-	-	4.5	A
$I_{SM}$	Maximum Pulsed Drain to Source Diode Forward Current		-	-	12	A
$V_{SD}$	Drain to Source Diode Forward Voltage	$V_{GS} = 0V, I_S = 3A$	-	-	1.3	V
$t_{rr}$	Body Diode Reverse Recovery Time	$V_{GS} = 0V, I_F = 3A, di/dt = 100A/\mu s$	-	32.1	-	ns
$Q_{rr}$	Body Diode Reverse Recovery Time		-	39.4	-	nC
$I_{rrm}$	Peak Reverse Recovery Current		-	2.1	-	A

## Notes:

- 1.Repetitive Rating: Pulse width limited by maximum junction temperature.
- 2.Surface Mounted on FR4 Board,  $t \leq 10$  sec.
- 3.Pulse Test: Pulse Width  $\leq 300\mu s$ , Duty Cycle  $\leq 2\%$ .
- 4.Guaranteed by design, not subject to production
5. $V_{DD} = 50V, R_G = 50\Omega, L = 0.3mH$ , starting  $T_J = 25^\circ\text{C}$



Typical Electrical and Thermal Characteristics (Curves)

Figure 1: Output Characteristics

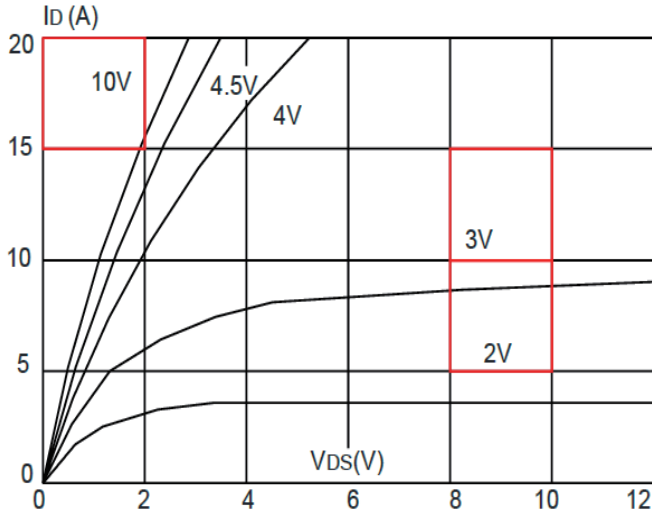

Figure 2: Typical Transfer Characteristics

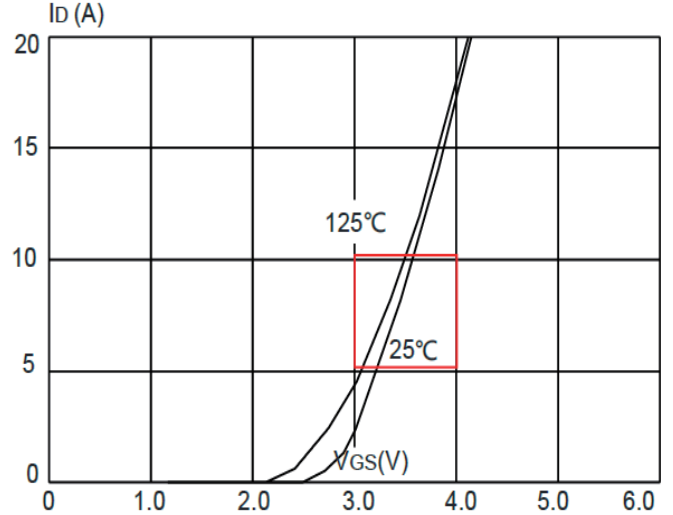

Figure 3: On-resistance vs. Drain Current

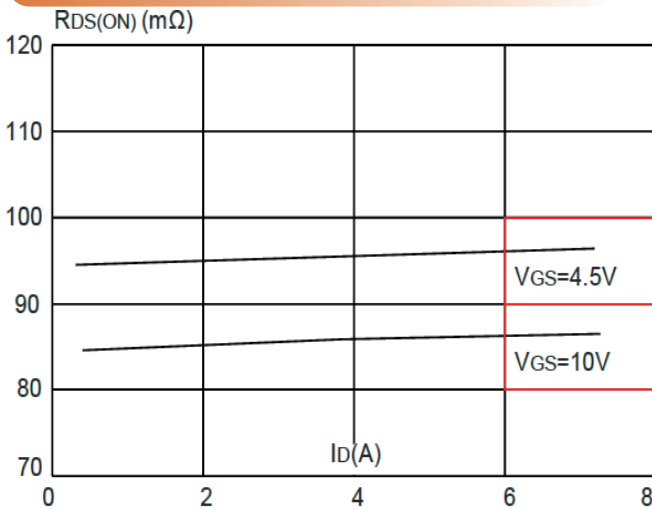

Figure 4: Body Diode Characteristics

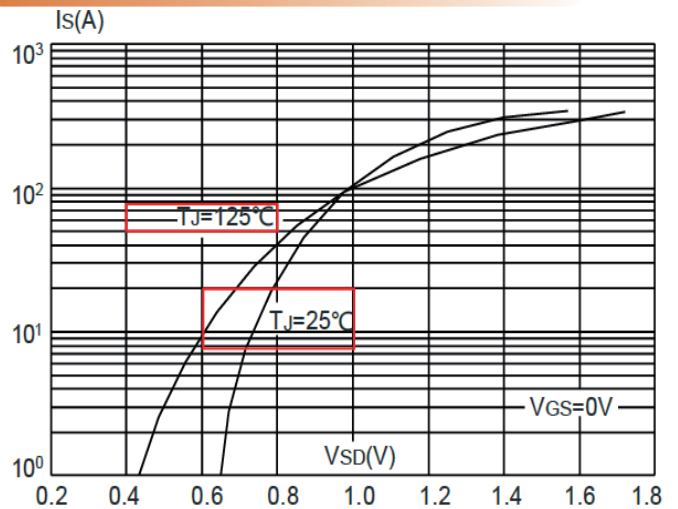

Figure 5: Gate Charge Characteristics

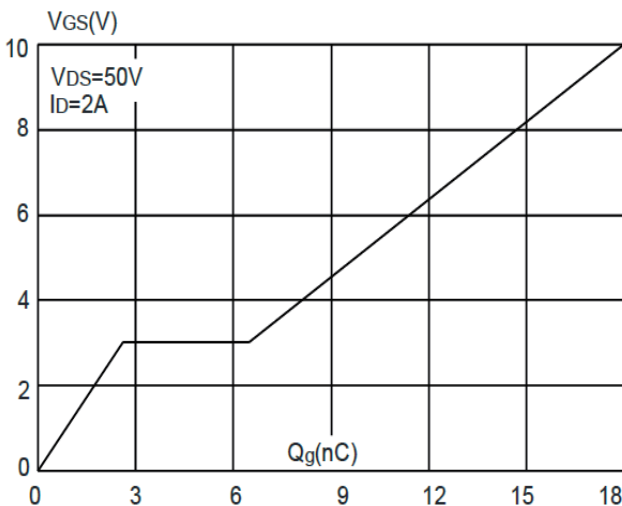
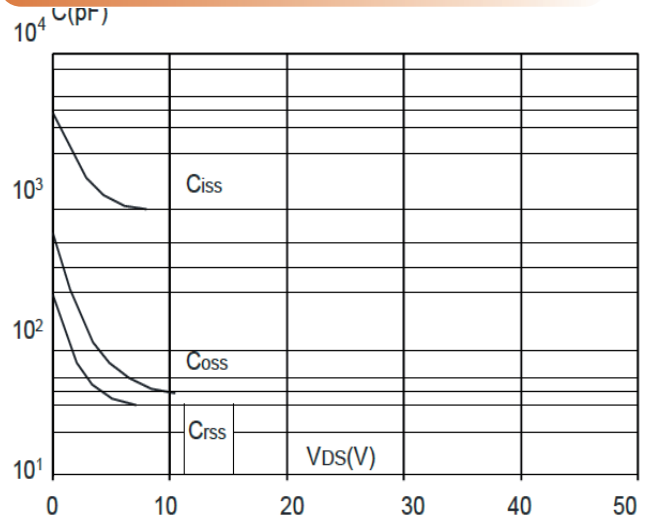

Figure 6: Capacitance Characteristics



## Typical Performance Characteristics

Figure 7: Normalized Breakdown Voltage vs. Junction Temperature

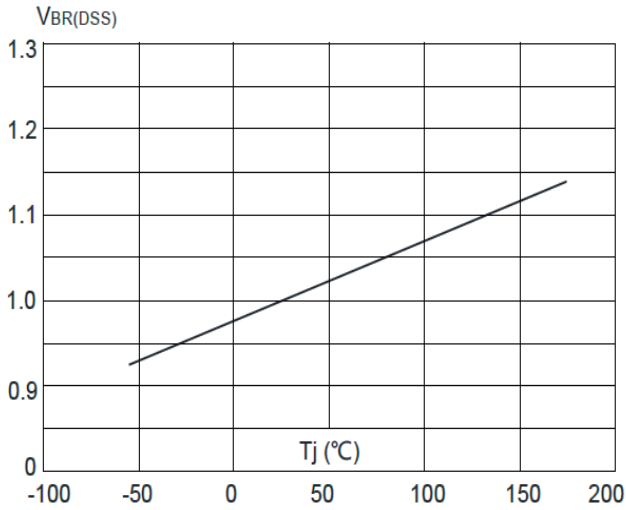

Figure 8: Normalized on Resistance vs. Junction Temperature

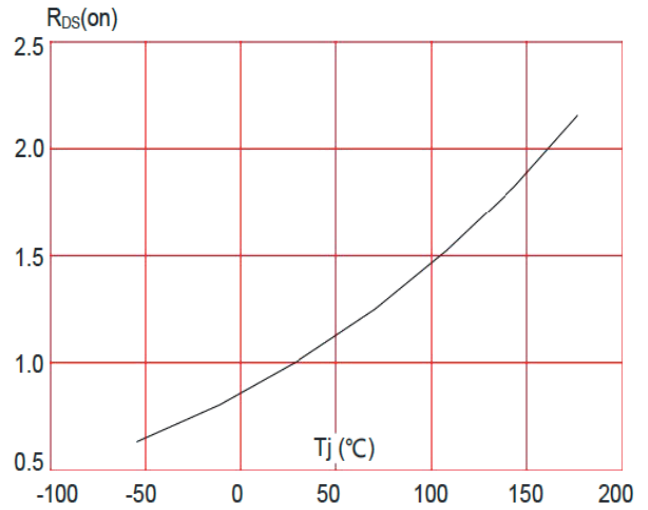

Figure 9: Maximum Safe Operating Area

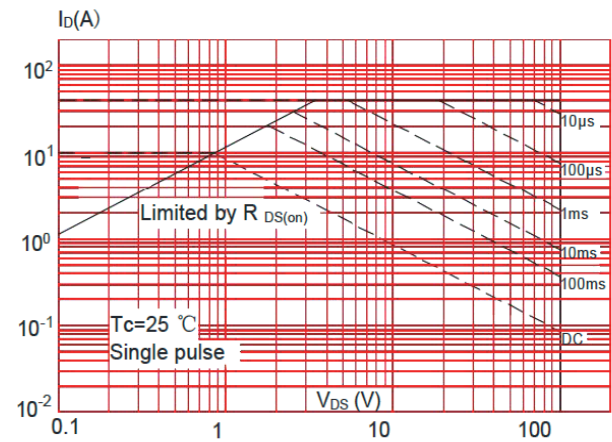

Figure 10: Maximum Continuous Drain Current vs. Case Temperature

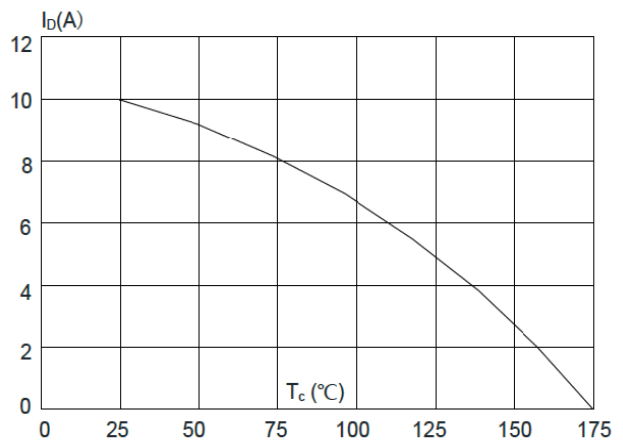
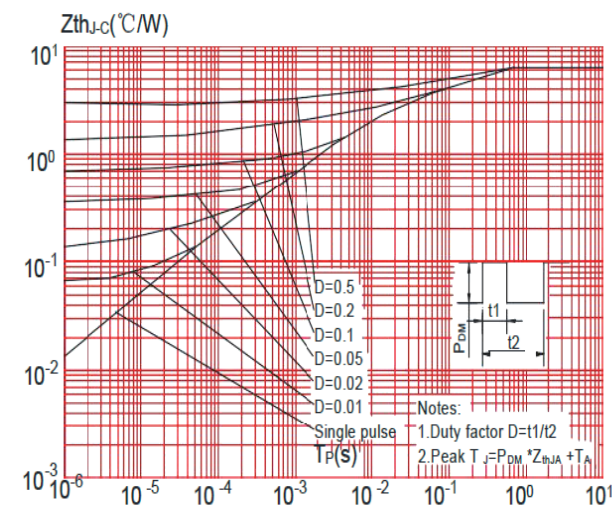
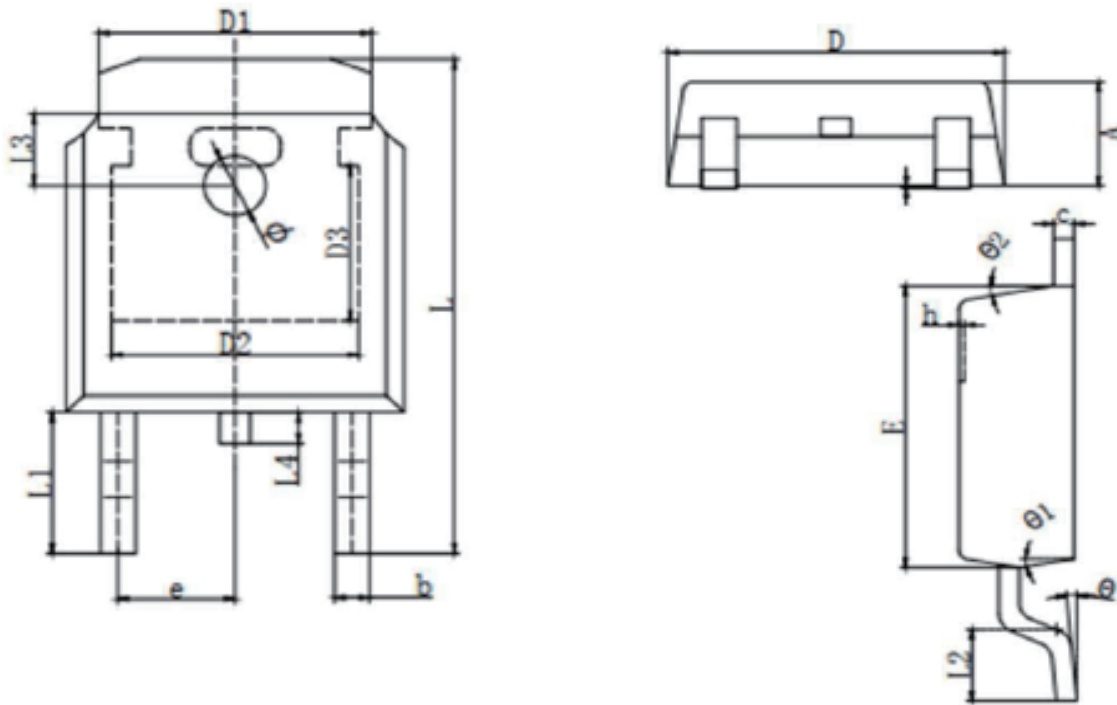

Figure 11 Maximum Effective Transient Thermal Impedance Junction to Case



TO-252 Package outline



SYMBOL	MILLIMETER		SYMBOL	MILLIMETER	
	MIN	MAX		MIN	MAX
A	2.200	2.400	h	0.000	0.200
A1	0.000	0.127	L	9.900	10.30
b	0.640	0.740	L1	2.888 REF	
c	0.460	0.580	L2	1.400	1.700
D	6.500	6.700	L3	1.600 REF	
D1	5.334 REF		L4	0.600	1.000
D2	4.826 REF		$\phi$	1.100	1.300
D3	3.166 REF		$\theta$	0°	8°
E	6.000	6.200	$\theta 1$	9° TYP2	
e	2.286 TYP		$\theta 2$	9° TYP	

## X-ON Electronics

Largest Supplier of Electrical and Electronic Components

*Click to view similar products for [MOSFET](#) category:*

*Click to view products by [HL](#) manufacturer:*

Other Similar products are found below :

[IRFD120](#) [JANTX2N5237](#) [2SK2267\(Q\)](#) [BUK455-60A/B](#) [TK100A10N1,S4X\(S](#) [MIC4420CM-TR](#) [VN1206L](#) [NDP4060](#) [SI4482DY](#)  
[IRS2092STRPBF-EL](#) [IPS70R2K0CEAKMA1](#) [TK31J60W5,S1VQ\(O](#) [TK31J60W,S1VQ\(O](#) [TK16J60W,S1VQ\(O](#) [2SK2614\(TE16L1,Q\)](#)  
[DMN1017UCP3-7](#) [EFC2J004NUZTDG](#) [P85W28HP2F-7071](#) [DMN1053UCP4-7](#) [NTE2384](#) [DMC2700UDMQ-7](#) [DMN2080UCB4-7](#)  
[DMN61D9UWQ-13](#) [US6M2GTR](#) [DMN31D5UDJ-7](#) [DMP22D4UFO-7B](#) [IPS60R3K4CEAKMA1](#) [DMN1006UCA6-7](#) [DMN16M9UCA6-7](#)  
[STF5N65M6](#) [IRF40H233XTMA1](#) [STU5N65M6](#) [DMN6022SSD-13](#) [DMN13M9UCA6-7](#) [DMTH10H4M6SPS-13](#) [IPS60R360PFD7SAKMA1](#)  
[DMN2990UFB-7B](#) [SSM3K35CT,L3F](#) [IPLK60R1K0PFD7ATMA1](#) [2N7002W-G](#) [MCAC30N06Y-TP](#) [IPWS65R035CFD7AXKSA1](#)  
[MCQ7328-TP](#) [SSM3J143TU,LXHF](#) [PJMF280N65E1\\_T0\\_00201](#) [PJMF380N65E1\\_T0\\_00201](#) [PJMF280N60E1\\_T0\\_00201](#)  
[PJMF600N65E1\\_T0\\_00201](#) [PJMF900N65E1\\_T0\\_00201](#) [PJMF900N60E1\\_T0\\_00201](#)