

序号 (NO.)	品名 (Name)	材质 (Material)
①	A型立式胶芯 1.25 Pitch S/T Wire To Board Housing(H=4.9)	LCP UL94V-0 本色 Natural
②	A型立式WTB端子 1.25 Pitch S/T Wire To Board Terminal (H=4.9)	铜合金/表面镀锡 Copper Alloy/ Tin Plating
③	A型立式WTB焊片 1.25 Pitch S/T Wire To Board Fitting Nail (H=4.9)	铜合金/表面镀锡 Copper Alloy/ Tin Plating
④	A型立式WTB吸盖 1.25 Pitch S/T Wire To Board Cover (H=4.9)	LCP UL94V-0 本色 Natural

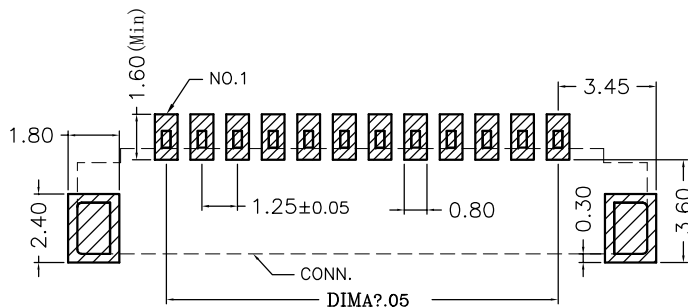
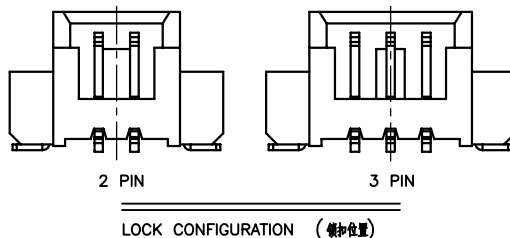
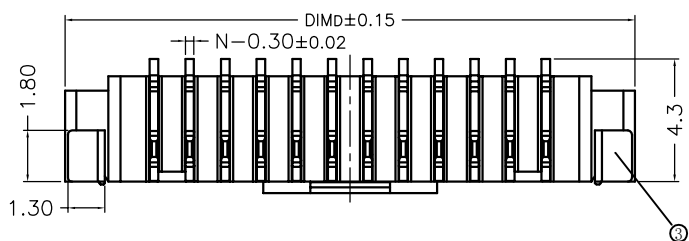
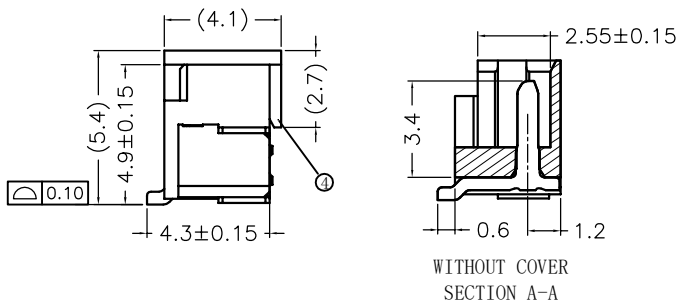
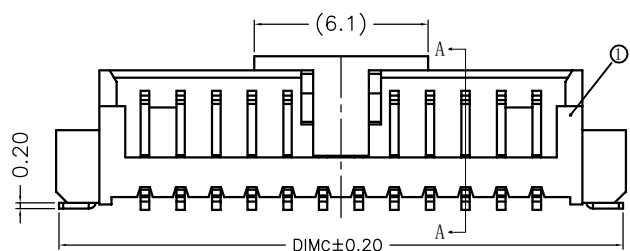
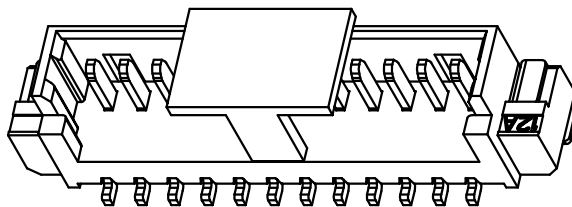
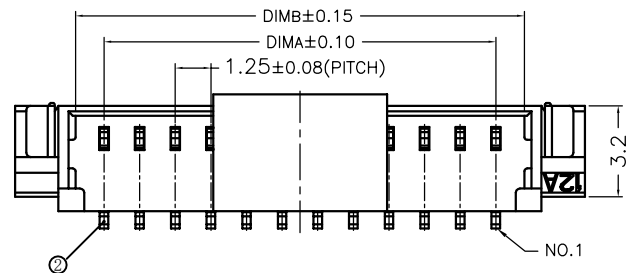

适用线路板 (PCB LAYOUT)

CKT	DIM A	DIM B	DIM C	DIM D
2	1.25	3.25	7.30	7.50
3	2.50	4.50	8.55	8.75
4	3.75	5.75	9.80	10.00
5	5.00	7.00	11.05	11.25
6	6.25	8.25	12.30	12.50
7	7.50	9.50	13.55	13.75
8	8.75	10.75	14.80	15.00
9	10.00	12.00	16.05	16.25
10	11.25	13.25	17.30	17.50
11	12.50	14.50	18.55	18.75
12	13.75	15.75	19.80	20.00
13	15.00	17.00	21.05	21.25
14	16.25	18.25	22.30	22.50
15	17.50	19.50	23.55	23.75
16	18.75	20.75	24.80	25.00
17	20.00	22.00	26.05	26.25
18	21.25	23.25	27.30	27.50
19	22.50	24.50	28.55	28.75
20	23.75	25.75	29.80	30.00

技术指标 (Technical Index):

1. 塑件表面应光洁、无毛边、无明显收缩、缺陷、裂纹等现象。(The surface of the plastic parts should be smooth, no rough edges, no obvious shrinkage, defects, cracks and other phenomena)
2. 锁扣窗口: 2~3PIN为1个, ≥4PIN为2个。(Lock Configuration: 2 to 3Pin is 1, ≥4Pin is 2)
3. 不同Pin位吸盖加入/取出力有差异, 实属正常现象。(It is normal that there are differences between suction cap and suction cap at different Pin positions)
4. 温度范围 (Temperature range): -65° C~125° C.
5. 额定电压 (Rated voltage): 125V, AC/DC (=等效).
6. 接触电阻 (Contact resistance): ≤0.02Ω.
7. 绝缘电阻 (Insulation resistance): ≥100MΩ

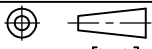

深圳市华宇创精密电子有限公司

TOLERANCE: X.X ±0.30 X.XX ±0.25 X.XXX ±0.15 X' ±2' X.X' ±0.5'	DRAWN BY :	DATE :	PART NAME:
	陈一鸣	2014-02-23	1.25PH 立式贴片wafer
 UNIT: mm [inch] SCALE:1:1 SIZE: A4	CHECKED BY:	DATE :	PART NO.
	马跃	2014-02-23	HYCW01-LFN-125B
APPROVED BY:	DATE :	DRAW NO:	SHEET NO.
	邱敏	2014-02-23	HYC-2112271007 1 OF 1

X-ON Electronics

Largest Supplier of Electrical and Electronic Components

Click to view similar products for [Headers & Wire Housings](#) category:

Click to view products by [HOAUC](#) manufacturer:

Other Similar products are found below :

[57102-F02-18ULF](#) [58102-G61-06LF](#) [0009485154](#) [009176003701906](#) [0050291907](#) [00-9021-0611-00-339](#) [02.125.8002.8](#) [609-3404](#) [61062-3](#)
[622-0430](#) [622-3653LF](#) [63453-116](#) [636-1030](#) [636-1427](#) [636-3427](#) [636-4007](#) [641938-9](#) [644827-2](#) [65495-038](#) [65692-001LF](#) [65781-018](#)
[65781-047](#) [65817-010LF](#) [65817-015LF](#) [66207-023LF](#) [67016-026LF](#) [67095-007LF](#) [68631-112](#) [68645-018](#) [68648-049](#) [699319-000](#)
[70.362.1628.0](#) [70-4210](#) [70-4226B](#) [70-4853B](#) [707-5020](#) [707-5028](#) [71.350.2428.0](#) [71961-016LF](#) [733-134](#) [754199-000](#) [760-3052](#) [787-8014-00](#)
[FCN-367T-T012/H](#) [80.063.4001.1](#) [800-90-001-10-001000](#) [800-90-010-10-002000](#) [801-43-002-10-013000](#) [801-43-006-10-002000](#)
[803-41-018-10-001000](#)