

3D View

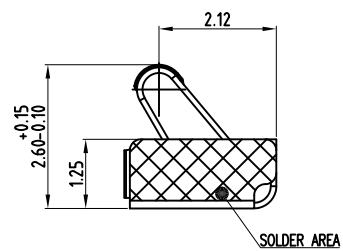

SOLDER AREA

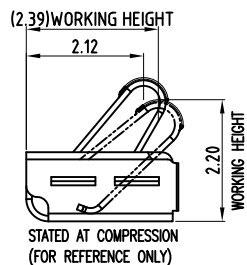

STATED AT COMPRESSION (FOR REFERENCE ONLY)

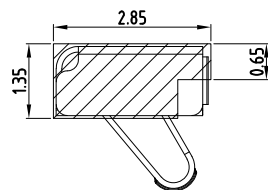
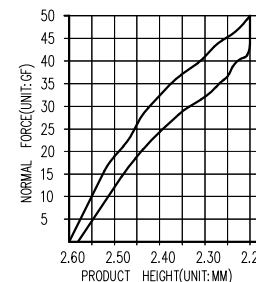
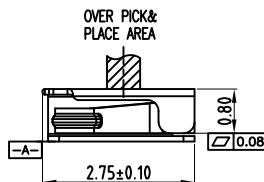

RECOMMENDED PCB LAYOUT  
TOLERANCE±0.05(焊盘推荐图)

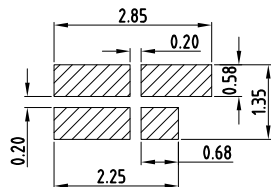

METAL MASK T=0.10  
TOLERANCE±0.05(钢网推荐图)

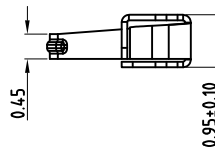

NOTES

- (1) MATERIAL: SUS-301 THICKNESS=0.10mm
- (2) PRODUCT SPECIFICATIONS:
  - 2-1: RATED CURRENT: 1.0A
  - 2-2: VOLTAGE RATING: 1.50V
  - 2-3: CONTACT RESISTANCE: 80mΩ/MAX
  - 2-4: WELDING THRUST: ≥ 3KG
  - 2-5: OPERATING TEMPERATURE: -40°C~+85°C
  - 2-6: DURABILITY: 1500 CYCLES
- (3) SALT SPRAY: 24 HOURS
- (4) REQUIREMENTS
  - 4-1: TERMINAL TO EAT FULL TIN, NOT PEELING  
WELDING OBVIOUS COLOR AND OTHER ADVERSE
  - 4-2: ROHS, REACH, HF HALOGEN ADVERSE OF DOMESTIC  
AND INTERNATIONAL ENVIRONMENTAL REQUIREMENTS

INSTRUCTIONS FOR USE

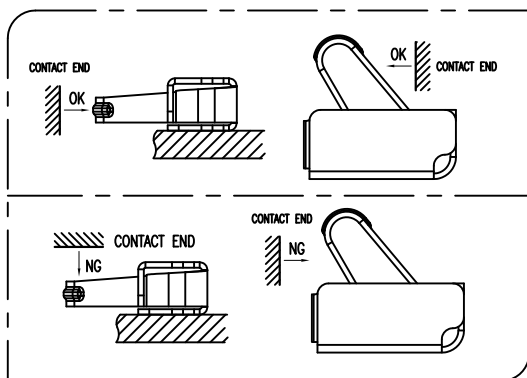

深圳市华宇创精密电子有限公司

TOLERANCE: X.X ±0.30 X.XX ±0.25 X.XXX ±0.15 X.' ±2' X.X' ±0.5'	DRAWN BY : 陈一鸣	DATE : 2014-02-23	PART NAME: 天线弹片 L2.75*W0.95*H2.62
	CHECKED BY: 马跃	DATE : 2014-02-23	PART NO. : HYCW-TXT275095262A
UNIT: mm [inch]	APPROVED BY: 邱敏	DATE : 2014-02-23	DRAW NO. : HYC-2406081057
SCALE: 1:1	SIZE: A4		SHEET NO. : 1 OF 1

## X-ON Electronics

Largest Supplier of Electrical and Electronic Components

*Click to view similar products for [Circuit Board Hardware - PCB category](#):*

*Click to view products by [HOAUC manufacturer](#):*

Other Similar products are found below :

[8919-0-00-15-00-00-03-0](#) [5970-1-15-01-32-14-04-0](#) [MKU 1 BLACK](#) [MLN 150/1 BLACK](#) [8579-1-15-15-11-27-10-0](#) [PRUEF 1 RED](#) [PRUEF 2 RED](#) [PW1616](#) [MPS 1 BLACK](#) [1548-103](#) [2317-2-00-50-00-00-07-0](#) [2506-2-00-50-00-00-07-0](#) [SCREWCLAMP EASY2](#) [SCREWCLAMPEASY750GEO](#) [9873-0-15-80-02-80-10-0](#) [2104-2-01-80-00-00-07-0](#) [PG-9](#) [2308-4-00-44-00-00-07-0](#) [2314-2-01-50-00-00-07-0](#) [2352-3-01-50-00-00-07-0](#) [2506-3-00-50-00-00-07-0](#) [251-103](#) [3330-1-00-15-00-00-03-0](#) [430-107](#) [TO-100-030](#) [TO-16-030E](#) [TO-203-040E](#) [TO-24-100](#) [TO-64-030](#) [5062-0-00-21-00-00-33-0](#) [5108](#) [325-102](#) [WLPL-141](#) [Z4.102.1680.0](#) [5119](#) [0153-4-15-80-30-27-04-0](#) [0252-0-15-01-32-27-10-0](#) [0253-0-15-15-30-27-10-0](#) [0255-0-15-01-30-27-04-0](#) [0290-0-00-15-00-00-03-0](#) [0309-2-15-80-47-27-10-0](#) [02-41](#) [0405-0-15-80-34-27-04-0](#) [0569-0-15-15-11-27-10-0](#) [0579-0-15-01-11-27-10-0](#) [0489-0-15-01-11-27-04-0](#) [0489-2-15-15-11-27-04-0](#) [0553-1-15-01-11-27-10-0](#) [0553-2-15-80-11-84-10-0](#) [0554-0-15-15-11-27-10-0](#)