

Features

- Ultra low quiescent current: 3.5 μ A (typ.)
- High input voltage (up to 12V)
- Output voltage: 1.8V, 2.5V, 2.7V, 3.0V, 3.3V, 3.5V, 4.15V, 5.0V
- Output voltage accuracy: tolerance \pm 3%
- Maximum output current: 250mA
- Low dropout voltage
- Low temperature coefficient
- TO-92, SOT-89 package

Applications

- Battery-powered equipment
- Voltage regulator for microprocessor
- Voltage regulator for LAN cards
- Wireless Communication equipment
- Audio/Video equipment

General Description

The HT73XX series is a set of three-terminal, low power, high voltage regulators implemented in CMOS technology. The series features extremely low quiescent current which is typically 3.5 μ A. They allow input voltages as high as 12V. The device provides large current with a significantly small dropout voltage.

The HT73XX consists of a high-precision voltage reference, an error correction circuit, and a current limited output driver. They are available with several fixed output voltages ranging from 1.8V to 5.0V. CMOS technology ensures low dropout voltage and low current consumption. Although designed primarily as fixed voltage regulators, these devices can be used with external components to generate variable voltages and currents.

Selection Table

Part No.	Output Voltage	Package	Marking
HT7318	1.8V	SOT89 TO92	73xx-A (for TO-92) 73xx-A (for SOT-89)
HT7325	2.5V		
HT7327	2.7V		
HT7330	3.0V		
HT7333	3.3V		
HT7335	3.5V		
HT7341	4.15V		
HT7350	5.0V		

Note: "xx" stands for output voltages.

Block Diagram

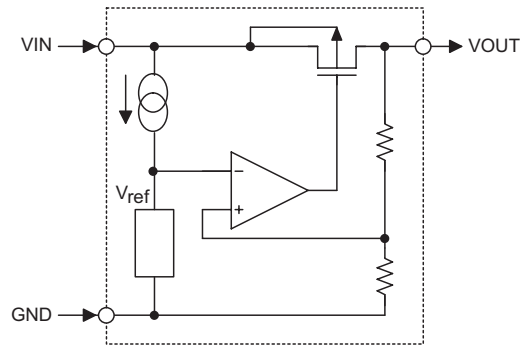

Pin Assignment

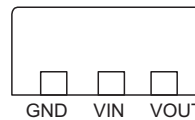
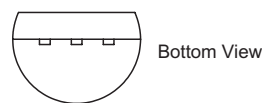
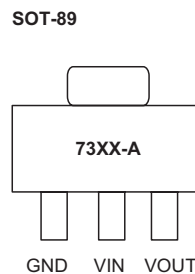
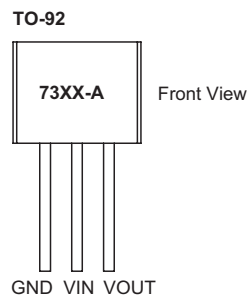

Pin Description

Pin No.		Pin Name	Description
SOT89	TO92		
1	1	GND	Ground pin
2	2	VIN	Input pin
3	3	VOUT	Output pin

Absolute Maximum Ratings*

Supply Voltage $V_{SS}-0.3V$ to $V_{SS}+14V$ Operating Temperature $-40^{\circ}C$ to $85^{\circ}C$
 Storage Temperature $-50^{\circ}C$ to $125^{\circ}C$ Power Consumption (*2) 500mW
 Power Consumption (*1) 500mW

Note: These are stress ratings only. Stresses exceeding the range specified under "Absolute Maximum Ratings" may cause substantial damage to the device. Functional operation of this device at other conditions beyond those listed in the specification is not implied and prolonged exposure to extreme conditions may affect device reliability.

*1: applied to TO-92

*2: applied to SOT-89

The guaranteed specifications apply only for the test conditions listed.

Electrical Characteristics

HT7318, +1.8V Output Type

 $T_a=25^{\circ}\text{C}$

Symbol	Parameter	Test Conditions		Min.	Typ.	Max.	Unit
		V _{IN}	Conditions				
V _{OUT}	Output Voltage	2.8V	I _{OUT} =40mA	1.746	1.800	1.854	V
I _{OUT(MAX)}	Maximum Output Current	2.8V	V _{OUT} ≥ 1.62V	150	—	—	mA
ΔV _{OUT} *	Load Regulation	2.8V	1mA ≤ I _{OUT} ≤ 60mA	—	45	90	mV
V _{DROP} **	Dropout Voltage	—	I _{OUT} =40mA	—	170	—	mV
I _{SS}	Quiescent Current	2.8V	No load	—	3.5	7	μA
$\frac{\Delta V_{OUT}}{\Delta V_{IN} \times V_{OUT}}$	Line Regulation	—	I _{OUT} =40mA 2.8V ≤ V _{IN} ≤ 12V	—	0.2	0.3	%/V
V _{IN}	Input Voltage	—	—	—	—	12	V
$\frac{\Delta V_{OUT}}{\Delta T_a}$	Temperature Coefficient	2.8V	I _{OUT} =40mA -40°C < T _a < 85°C	—	±0.7	—	mV/°C

HT7325, +2.5V Output Type

 $T_a=25^{\circ}\text{C}$

Symbol	Parameter	Test Conditions		Min.	Typ.	Max.	Unit
		V _{IN}	Conditions				
V _{OUT}	Output Voltage	3.5V	I _{OUT} =40mA	2.425	2.500	2.575	V
I _{OUT(MAX)}	Maximum Output Current	3.5V	V _{OUT} ≥ 2.25V	180	—	—	mA
ΔV _{OUT} *	Load Regulation	3.5V	1mA ≤ I _{OUT} ≤ 60mA	—	45	90	mV
V _{DROP} **	Dropout Voltage	—	I _{OUT} =40mA	—	110	—	mV
I _{SS}	Quiescent Current	3.5V	No load	—	3.5	7.0	μA
$\frac{\Delta V_{OUT}}{\Delta V_{IN} \times V_{OUT}}$	Line Regulation	—	I _{OUT} =40mA 3.5V ≤ V _{IN} ≤ 12V	—	0.2	0.3	%/V
V _{IN}	Input Voltage	—	—	—	—	12	V
$\frac{\Delta V_{OUT}}{\Delta T_a}$	Temperature Coefficient	3.5V	I _{OUT} =40mA -40°C < T _a < 85°C	—	±0.7	—	mV/°C

HT7327, +2.7V Output Type

 $T_a=25^{\circ}\text{C}$

Symbol	Parameter	Test Conditions		Min.	Typ.	Max.	Unit
		V _{IN}	Conditions				
V _{OUT}	Output Voltage	3.7V	I _{OUT} =40mA	2.619	2.700	2.781	V
I _{OUT(MAX)}	Maximum Output Current	3.7V	V _{OUT} ≥ 2.43V	200	—	—	mA
ΔV _{OUT} *	Load Regulation	3.7V	1mA ≤ I _{OUT} ≤ 80mA	—	45	90	mV
V _{DROP} **	Dropout Voltage	—	I _{OUT} =40mA	—	100	—	mV
I _{SS}	Quiescent Current	3.7V	No load	—	3.5	7.0	μA
$\frac{\Delta V_{OUT}}{\Delta V_{IN} \times V_{OUT}}$	Line Regulation	—	I _{OUT} =40mA 3.7V ≤ V _{IN} ≤ 12V	—	0.2	0.3	%/V
V _{IN}	Input Voltage	—	—	—	—	12	V
$\frac{\Delta V_{OUT}}{\Delta T_a}$	Temperature Coefficient	3.7V	I _{OUT} =40mA -40°C < T _a < 85°C	—	±0.7	—	mV/°C

HT7330, +3.0V Output Type

Ta=25°C

Symbol	Parameter	Test Conditions		Min.	Typ.	Max.	Unit
		V _{IN}	Conditions				
V _{OUT}	Output Voltage	4.0V	I _{OUT} =40mA	2.910	3.000	3.090	V
I _{OUT(MAX)}	Maximum Output Current	4.0V	V _{OUT} ≥ 2.70V	250	—	—	mA
ΔV _{OUT} *	Load Regulation	4.0V	1mA ≤ I _{OUT} ≤ 80mA	—	45	90	mV
V _{DROP} **	Dropout Voltage	—	I _{OUT} =40mA	—	95	—	mV
I _{SS}	Quiescent Current	4.0V	No load	—	3.5	7.0	μA
$\frac{\Delta V_{OUT}}{\Delta V_{IN} \times V_{OUT}}$	Line Regulation	—	I _{OUT} =40mA 4.0V ≤ V _{IN} ≤ 12V	—	0.2	0.3	%/V
V _{IN}	Input Voltage	—	—	—	—	12	V
$\frac{\Delta V_{OUT}}{\Delta T_a}$	Temperature Coefficient	4.0V	I _{OUT} =40mA -40°C < T _a < 85°C	—	±0.7	—	mV/°C

HT7333, +3.3V Output Type

Ta=25°C

Symbol	Parameter	Test Conditions		Min.	Typ.	Max.	Unit
		V _{IN}	Conditions				
V _{OUT}	Output Voltage	4.3V	I _{OUT} =40mA	3.201	3.300	3.399	V
I _{OUT(MAX)}	Maximum Output Current	4.3V	V _{OUT} ≥ 2.97V	250	—	—	mA
ΔV _{OUT} *	Load Regulation	4.3V	1mA ≤ I _{OUT} ≤ 80mA	—	45	90	mV
V _{DROP} **	Dropout Voltage	—	I _{OUT} =40mA	—	90	—	mV
I _{SS}	Quiescent Current	4.3V	No load	—	3.5	7.0	μA
$\frac{\Delta V_{OUT}}{\Delta V_{IN} \times V_{OUT}}$	Line Regulation	—	I _{OUT} =40mA 4.3V ≤ V _{IN} ≤ 12V	—	0.2	0.3	%/V
V _{IN}	Input Voltage	—	—	—	—	12	V
$\frac{\Delta V_{OUT}}{\Delta T_a}$	Temperature Coefficient	4.3V	I _{OUT} =40mA -40°C < T _a < 85°C	—	±0.7	—	mV/°C

HT7335, +3.5V Output Type

Ta=25°C

Symbol	Parameter	Test Conditions		Min.	Typ.	Max.	Unit
		V _{IN}	Conditions				
V _{OUT}	Output Voltage	4.5V	I _{OUT} =40mA	3.395	3.500	3.605	V
I _{OUT(MAX)}	Maximum Output Current	4.5V	V _{OUT} ≥ 3.15V	250	—	—	mA
ΔV _{OUT} *	Load Regulation	4.5V	1mA ≤ I _{OUT} ≤ 80mA	—	45	90	mV
V _{DROP} **	Dropout Voltage	—	I _{OUT} =40mA	—	80	—	mV
I _{SS}	Quiescent Current	4.5V	No load	—	3.5	7.0	μA
$\frac{\Delta V_{OUT}}{\Delta V_{IN} \times V_{OUT}}$	Line Regulation	—	I _{OUT} =40mA 4.5V ≤ V _{IN} ≤ 12V	—	0.2	0.3	%/V
V _{IN}	Input Voltage	—	—	—	—	12	V
$\frac{\Delta V_{OUT}}{\Delta T_a}$	Temperature Coefficient	4.5V	I _{OUT} =80mA -40°C < T _a < 85°C	—	±0.7	—	mV/°C

HT7341, +4.15V Output Type

Ta=25°C

Symbol	Parameter	Test Conditions		Min.	Typ.	Max.	Unit
		V _{IN}	Conditions				
V _{OUT}	Output Voltage	5.15V	I _{OUT} =40mA	4.025	4.150	4.275	V
I _{OUT(MAX)}	Maximum Output Current	5.15V	V _{OUT} ≥ 3.74V	250	—	—	mA
ΔV _{OUT} *	Load Regulation	5.15V	1mA ≤ I _{OUT} ≤ 80mA	—	45	90	mV
V _{DROP} **	Dropout Voltage	—	I _{OUT} =40mA	—	60	—	mV
I _{SS}	Quiescent Current	5.15V	No load	—	3.5	7.0	μA
$\frac{\Delta V_{OUT}}{\Delta V_{IN} \times V_{OUT}}$	Line Regulation	—	I _{OUT} =40mA 6.0V ≤ V _{IN} ≤ 12.0V	—	0.2	0.3	%/V
V _{IN}	Input Voltage	—	—	—	—	12	V
$\frac{\Delta V_{OUT}}{\Delta T_a}$	Temperature Coefficient	5.15V	I _{OUT} =80mA -40°C < Ta < 85°C	—	±0.7	—	mV/°C

HT7350, +5.0V Output Type

Ta=25°C

Symbol	Parameter	Test Conditions		Min.	Typ.	Max.	Unit
		V _{IN}	Conditions				
V _{OUT}	Output Voltage	6.0V	I _{OUT} =40mA	4.850	5.000	5.150	V
I _{OUT(MAX)}	Maximum Output Current	6.0V	V _{OUT} ≥ 4.50V	250	—	—	mA
ΔV _{OUT} *	Load Regulation	6.0V	1mA ≤ I _{OUT} ≤ 100mA	—	45	90	mV
V _{DROP} **	Dropout Voltage	—	I _{OUT} =40mA	—	60	—	mV
I _{SS}	Quiescent Current	6.0V	No load	—	3.5	7.0	μA
$\frac{\Delta V_{OUT}}{\Delta V_{IN} \times V_{OUT}}$	Line Regulation	—	I _{OUT} =40mA 6.0V ≤ V _{IN} ≤ 12.0V	—	0.2	0.3	%/V
V _{IN}	Input Voltage	—	—	—	—	12	V
$\frac{\Delta V_{OUT}}{\Delta T_a}$	Temperature Coefficient	6.0V	I _{OUT} =80mA -40°C < Ta < 85°C	—	±0.7	—	mV/°C

Note: "*" Regulation is measured at constant junction temperature, using pulsed ON time.

"**" Dropout is measured at constant junction temperature, using pulsed ON time, and the criterion is V_{OUT} inside target value ±2%.

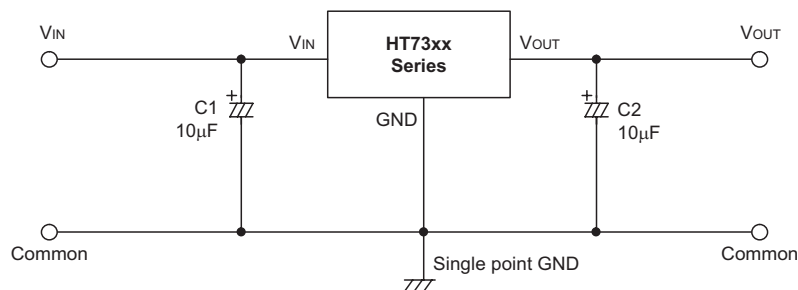
Application Circuits

Package Information

Note that the package information provided here is for consultation purposes only. As this information may be updated at regular intervals users are reminded to consult the [Holtek website](#) for the latest version of the [Package/ Carton Information](#).

Additional supplementary information with regard to packaging is listed below. Click on the relevant section to be transferred to the relevant website page.

- Package Information (include Outline Dimensions, Product Tape and Reel Specifications)
- The Operation Instruction of Packing Materials
- Carton information

3-pin TO92 Outline Dimensions

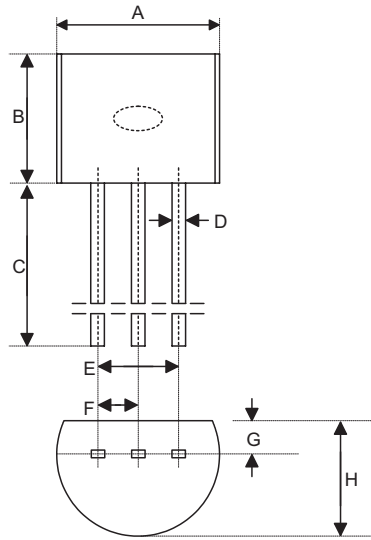

Symbol	Dimensions in inch		
	Min.	Nom.	Max.
A	0.173	0.180	0.205
B	0.170	—	0.210
C	0.500	0.580	—
D	—	0.015 BSC	—
E	—	0.010 BSC	—
F	—	0.050 BSC	—
G	—	0.035 BSC	—
H	0.125	0.142	0.165

Symbol	Dimensions in mm		
	Min.	Nom.	Max.
A	4.39	4.57	5.21
B	4.32	—	5.33
C	12.70	14.73	—
D	—	0.38 BSC	—
E	—	2.54 BSC	—
F	—	1.27 BSC	—
G	—	0.89 BSC	—
H	3.18	3.61	4.19

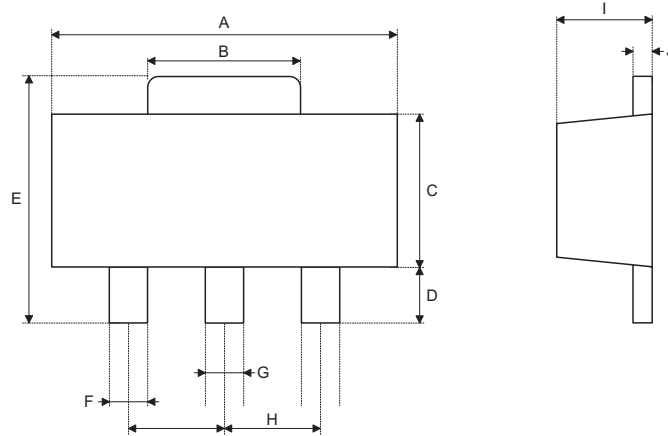
3-pin SOT89 Outline Dimensions

Symbol	Dimensions in inch		
	Min.	Nom.	Max.
A	0.173	—	0.181
B	0.053	—	0.072
C	0.090	—	0.102
D	0.035	—	0.047
E	0.155	—	0.167
F	0.014	—	0.019
G	0.017	—	0.022
H	—	0.059 BSC	—
I	0.055	—	0.063
J	0.014	—	0.017

Symbol	Dimensions in mm		
	Min.	Nom.	Max.
A	4.40	—	4.60
B	1.35	—	1.83
C	2.29	—	2.60
D	0.89	—	1.20
E	3.94	—	4.25
F	0.36	—	0.48
G	0.44	—	0.56
H	—	1.50 BSC	—
I	1.40	—	1.60
J	0.35	—	0.44

Copyright© 2016 by HOLTEK SEMICONDUCTOR INC.

The information appearing in this Data Sheet is believed to be accurate at the time of publication. However, Holtek assumes no responsibility arising from the use of the specifications described. The applications mentioned herein are used solely for the purpose of illustration and Holtek makes no warranty or representation that such applications will be suitable without further modification, nor recommends the use of its products for application that may present a risk to human life due to malfunction or otherwise. Holtek's products are not authorized for use as critical components in life support devices or systems. Holtek reserves the right to alter its products without prior notification. For the most up-to-date information, please visit our web site at <http://www.holtek.com.tw>.

X-ON Electronics

Largest Supplier of Electrical and Electronic Components

Click to view similar products for [LDO Voltage Regulators](#) category:

Click to view products by [Holtek](#) manufacturer:

Other Similar products are found below :

[AP7363-SP-13](#) [L79M05TL-E](#) [AP7362-HA-7](#) [PT7M8202B12TA5EX](#) [TCR3DF185,LM\(CT](#) [TCR3DF45,LM\(CT](#) [TLE4473G V52](#) [059985X](#)
[NCP4687DH15T1G](#) [701326R](#) [NCV8170AXV250T2G](#) [AP7315-25W5-7](#) [AP2111H-1.2TRG1](#) [ZLDO1117QK50TC](#) [AZ1117ID-ADJTRG1](#)
[TCR3DG12,LF](#) [MIC5514-3.3YMT-T5](#) [SCD7912BTG](#) [NCP154MX180270TAG](#) [SCD33269T-5.0G](#) [NCV8170BXV330T2G](#)
[NCV8170BMX330TCG](#) [NCV8170AMX120TCG](#) [NCP706ABMX300TAG](#) [NCP153MX330180TCG](#) [NCP114BMX075TCG](#) [MC33269T-3.5G](#)
[CAT6243-ADJCMT5T](#) [TCR3DG33,LF](#) [TCR4DG35,LF](#) [TAR5S15U\(TE85L,F\)](#) [TAR5S18U\(TE85L,F\)](#) [TCR3UG19A,LF](#) [TCR4DG105,LF](#)
[MPQ2013AGG-5-P](#) [NCV8170AMX360TCG](#) [TLE4268GSXUMA2](#) [NCP715SQ15T2G](#) [MIC5317-3.0YD5-T5](#) [NCV563SQ18T1G](#)
[NCP715MX30TBG](#) [NCV8702MX25TCG](#) [NCV8170BXV120T2G](#) [MIC5317-1.2YD5-T5](#) [NCV8170AMX150TCG](#) [NCV8170BMX150TCG](#)
[AP2213D-3.3TRG1](#) [NCV8170BMX120TCG](#) [NCV8170BMX310TCG](#) [NCV8170BMX360TCG](#)