

Features

- Low startup voltage: 0.85V (Typical)
- High efficiency Up to 85%
- Ultra low no load input current
- High output voltage accuracy: $\pm 2.5\%$
- Fixed output voltage: 1.8V, 2.2V, 2.7V, 3.0V, 3.3V, 3.7V and 5.0V
- Ultra low shutdown current: 0.1 μ A (Typical)
- Package type: 3-pin SOT89, 3-pin SOT23 and 5-pin SOT23

Applications

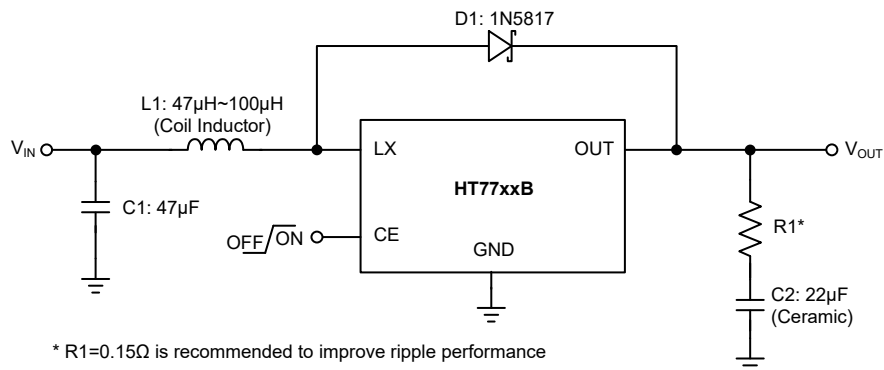
- One, two and three cell alkaline and NiMH/NiCd battery powered portable products
- Portable equipment/handheld devices

General Description

The HT77xxB series is a set of PFM step-up DC/DC converters with high efficiency and low ripple. The series features extremely low start-up voltage and high output voltage accuracy. They require only few external components to provide a fixed output voltage of 1.8V, 2.2V, 2.7V, 3.0V, 3.3V, 3.7V and 5.0V. CMOS technology ensures low supply current and makes them ideal for battery-operated applications powered from one or more cells.

The HT77xxB series consist of an oscillator, a PFM control circuit, a driver transistor, a reference voltage unit and a high speed comparator. They employ pulse frequency modulation (PFM) for minimum supply current and ripple at light output loading. These devices are available in space saving 3-pin SOT89, 3-pin SOT23 and 5-pin SOT23 packages. For the 5-pin SOT23 package, it also contains a chip enable function to reduce power consumption during shutdown mode.

Typical Application Circuits

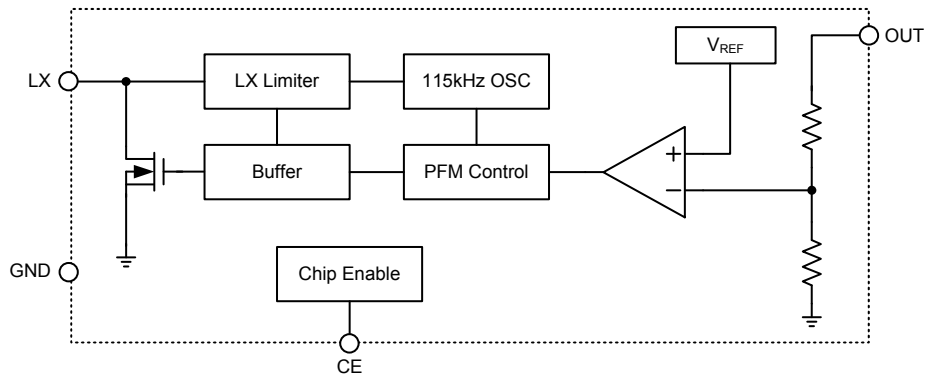


Selection Table

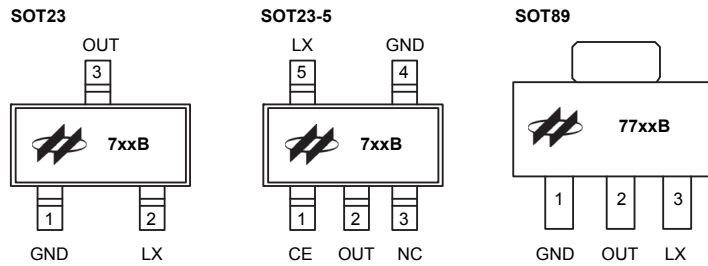
Part No.	Output Voltage	Packages	Markings
HT7718B	1.8V	SOT89 SOT23 SOT23-5	77xxB marking for SOT89 type 7xxB marking for SOT23 and SOT23-5 types
HT7722B	2.2V		
HT7727B	2.7V		
HT7730B	3.0V		
HT7733B	3.3V		
HT7737B	3.7V		
HT7750B	5.0V		

Note: "xx" stands for output voltages.

Block Diagram



Pin Assignment



Pin Description

Pin No.			Pin Name	Pin Description
SOT89	SOT23	SOT23-5		
—	—	1	CE	Chip enable pin, high active.
2	3	2	OUT	Output voltage pin
—	—	3	NC	No connection
1	1	4	GND	Ground pin
3	2	5	LX	Switching pin

Absolute Maximum Ratings

Parameter		Value	Unit
OUT		-0.3 to +6.0	V
LX and CE		-0.3 to +6.0	V
Maximum Junction Temperature		+150	°C
Storage Temperature Range		-65 to +150	°C
Lead Temperature (Soldering 10sec)		+260	°C
ESD Susceptibility	Human Body Mode	5000	V
	Machine Mode	400	V
Junction-to-Ambient Thermal Resistance, θ_{JA}	SOT89	200	°C/W
	SOT23	500	
	SOT23-5	500	
Power Dissipation, P_D	SOT89	0.625	W
	SOT23	0.25	
	SOT23-5	0.25	

Recommended Operating Ratings

Parameter	Value	Unit
V_{IN}	0.85 to 5	V
Operating Temperature Range	-40 to +85	°C

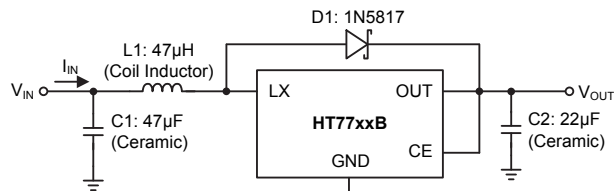
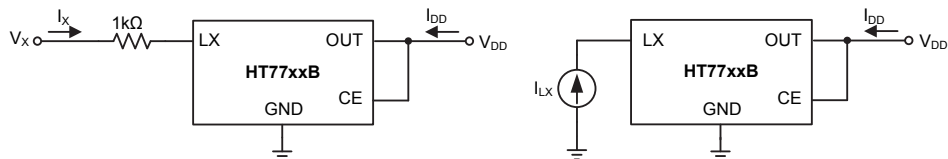
Note that Absolute Maximum Ratings indicate limitations beyond which damage to the device may occur. Recommended Operating Ratings indicate conditions for which the devices are intended to be functional, but do not guarantee specified performance limits.

Electrical Characteristics

 $V_{IN}=0.6 \times V_{OUT}$, $I_{OUT}=10\text{mA}$ and $T_a=+25^\circ\text{C}$, unless otherwise specified

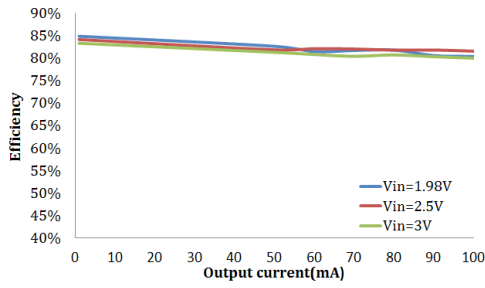
Symbol	Parameter	Test Condition	Min.	Typ.	Max.	Unit	
V_{IN}	Input Voltage Range	—	—	—	5.5	V	
ΔV_{OUT}	Output Voltage Accuracy	—	-2.5	—	+2.5	%	
V_{ST}	Startup Voltage (Fig.1)	$V_{IN}: 0\text{V} \rightarrow 2\text{V}$, $I_{OUT}=1\text{mA}$	—	0.85	1	V	
V_{HOLD}	Hold on Voltage (Fig.1)	$V_{IN}: 2\text{V} \rightarrow 0\text{V}$, $I_{OUT}=1\text{mA}$	—	—	0.7	V	
I_{IN}	No Load Input Current (Fig.1)	$I_{OUT}=0\text{mA}$	8	10	20	μA	
I_{DD}	Non-switching Current (Fig.2)	$V_{DD}=V_{OUT}+0.5\text{V}$, $V_X=\text{floating}$	—	5	10	μA	
I_{SHDN}	Shutdown Current (Fig.1)	$CE=\text{GND}$	—	0.1	1	μA	
$R_{DS(ON)}$	On Resistance (Fig.3)	$V_{DD}=1.7\text{V}$, $I_{LX}=300\text{mA}$	$V_{OUT}=1.8\text{V}$	—	0.65	—	Ω
		$V_{DD}=2.1\text{V}$, $I_{LX}=300\text{mA}$	$V_{OUT}=2.2\text{V}$	—	0.56	—	
		$V_{DD}=2.6\text{V}$, $I_{LX}=300\text{mA}$	$V_{OUT}=2.7\text{V}$	—	0.46	—	
		$V_{DD}=2.9\text{V}$, $I_{LX}=300\text{mA}$	$V_{OUT}=3.0\text{V}$	—	0.44	—	
		$V_{DD}=3.2\text{V}$, $I_{LX}=300\text{mA}$	$V_{OUT}=3.3\text{V}$	—	0.43	—	
		$V_{DD}=3.6\text{V}$, $I_{LX}=300\text{mA}$	$V_{OUT}=3.7\text{V}$	—	0.41	—	
		$V_{DD}=4.85\text{V}$, $I_{LX}=300\text{mA}$	$V_{OUT}=5.0\text{V}$	—	0.39	—	
V_{IH}	CE High Threshold	—	1.6	—	—	V	
V_{IL}	CE Low Threshold	—	—	—	0.4	V	
I_{LEAK}	LX Leakage Current (Fig.2)	$V_{DD}=V_X=V_{OUT}+0.5\text{V}$, measured at LX pin	—	—	1	μA	
f_{OSC}	Maximum Oscillator Frequency (Fig.2)	$V_{DD}=0.9 \times V_{OUT}$, $V_X=5.5\text{V}$, measured at LX pin	—	115	—	kHz	
D_{OSC}	Oscillator Duty Cycle (Fig.2)	$V_{DD}=0.9 \times V_{OUT}$, $V_X=5.5\text{V}$, measured at LX pin	65	75	85	%	
η	Efficiency	—	—	85	—	%	

Note: Absolute maximum ratings indicate limits beyond which damage to the device may occur. Operating Ratings indicate conditions for which the devices are intended to be functional, but do not guarantee specific performance limits. The guaranteed specifications apply only for the test conditions listed.

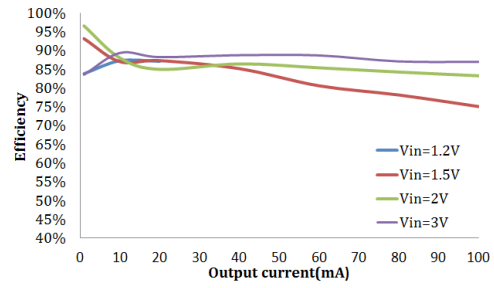

Fig. 1

Fig. 2
Fig. 3

Typical Performance Characteristics

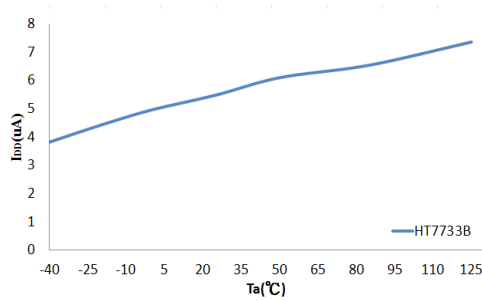
$V_{IN}=0.6 \times V_{OUT}$, $C_{IN}=47\mu F$, $C_{OUT}=22\mu F$, $L=47\mu H$, $T_a=25^\circ C$, unless otherwise specified



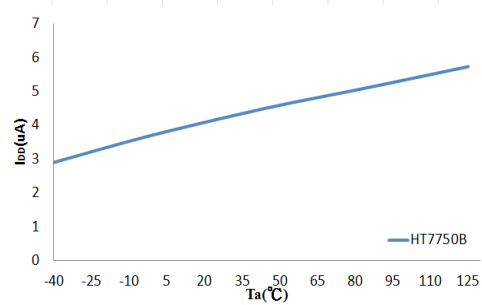
HT7733B Efficiency vs. Output Current



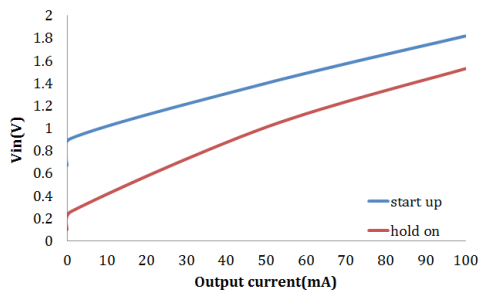
HT7750B Efficiency vs. Output Current



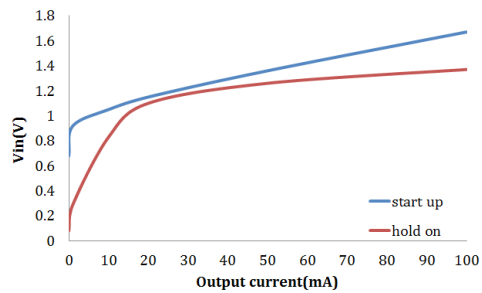
HT7733B I_{DD} vs. T_a



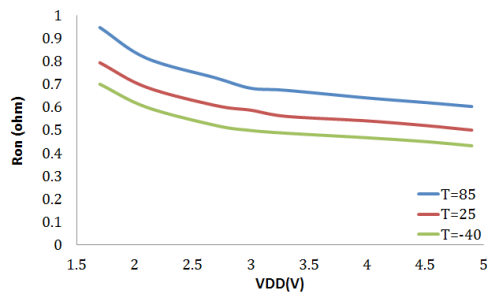
HT7750B I_{DD} vs. T_a



HT7733B Startup/Hold-on Voltage

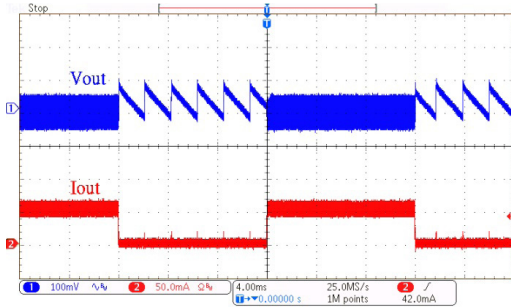


HT7750B Startup/Hold-on Voltage

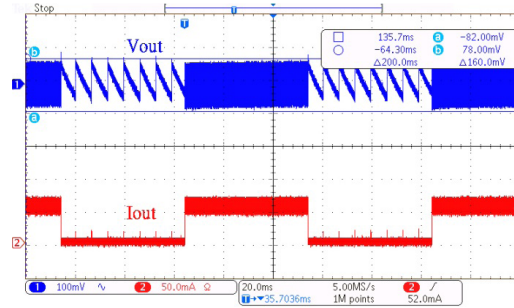


R_{ON} vs. V_{DD}

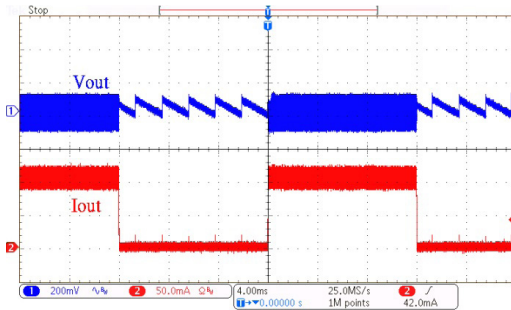
$V_{IN}=0.6 \times V_{OUT}$, $C_{IN}=47\mu F$, $C_{OUT}=22\mu F$, $L=47\mu H$, $T_a=25^\circ C$, unless otherwise specified



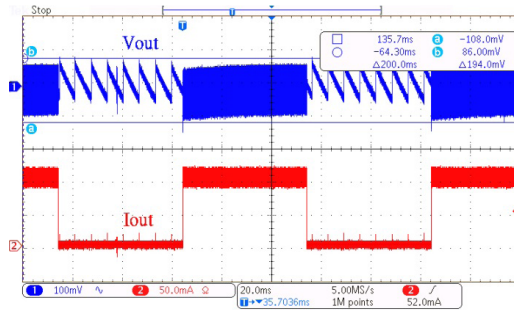
HT7733B Load Transient (1mA to 50mA)



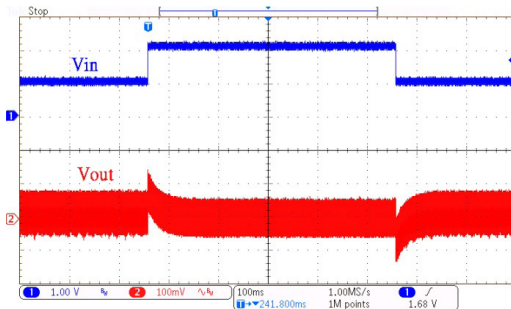
HT7750B Load Transient (1mA to 50mA)



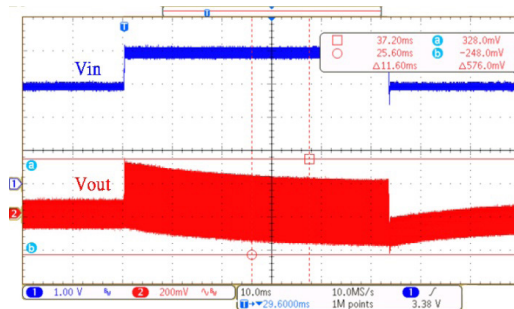
HT7733B Load Transient (1mA to 100mA)



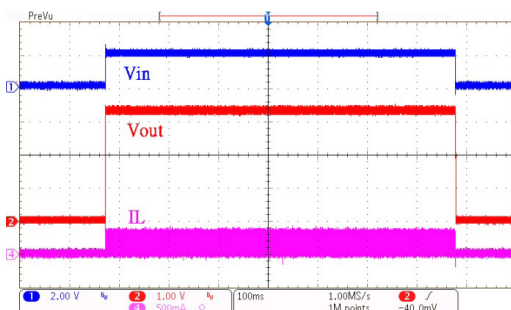
HT7750B Load Transient (1mA to 100mA)



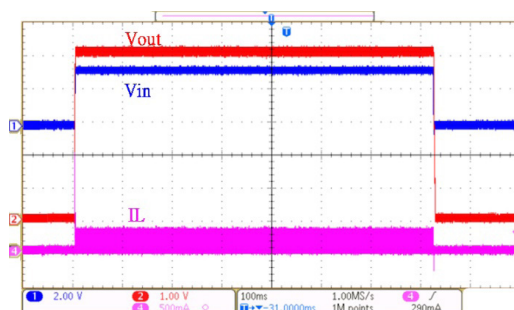
HT7733B Line Transient (1V to 2V, $I_{OUT}=50mA$)



HT7750B Line Transient (3V to 4V, $I_{OUT}=200mA$)

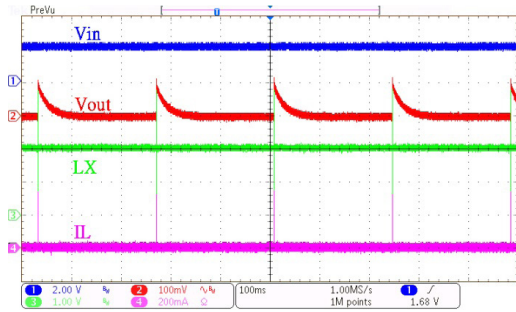


HT7733B Power ON/OFF ($I_{OUT}=50mA$)

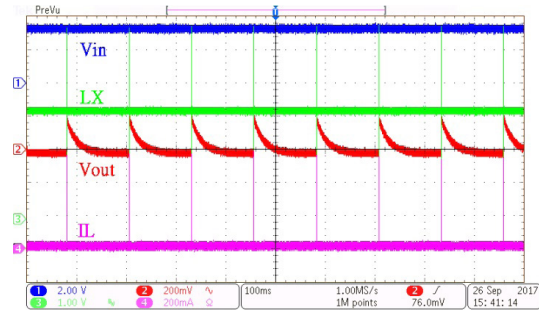


HT7750B Power ON/OFF ($I_{OUT}=50mA$)

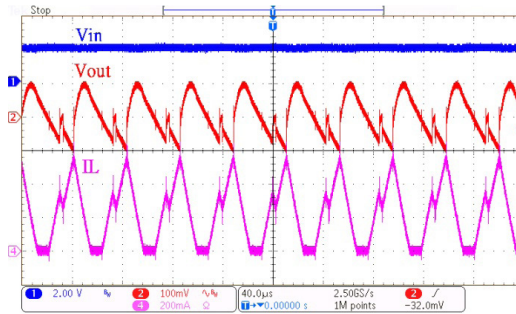
$V_{IN}=0.6 \times V_{OUT}$, $C_{IN}=47\mu F$, $C_{OUT}=22\mu F$, $L=47\mu H$, $T_a=25^\circ C$, unless otherwise specified



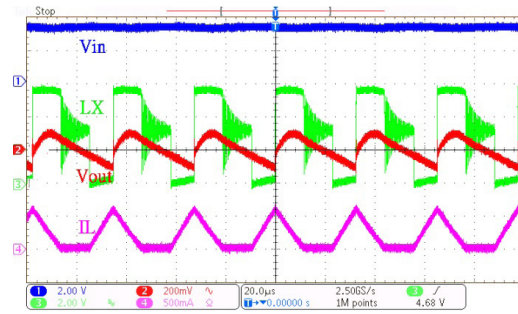
HT7733B Operation ($I_{OUT}=0mA$)



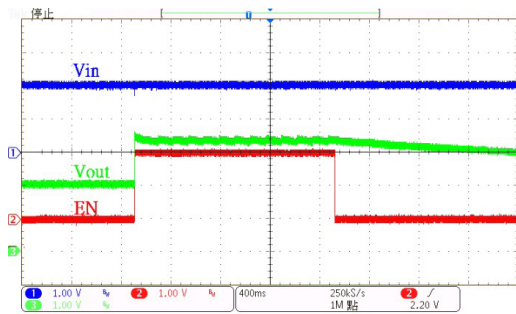
HT7750B Operation ($I_{OUT}=0mA$)



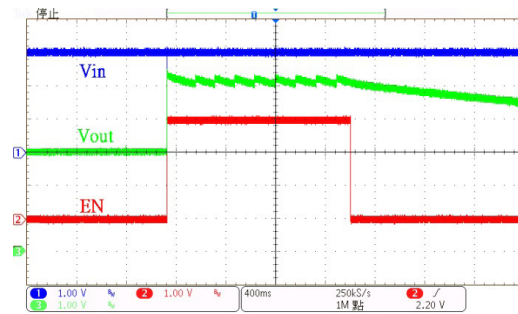
HT7733B Operation ($I_{OUT}=100mA$)



HT7750B Operation ($I_{OUT}=100mA$)



HT7733B Chip Enable/Disable



HT7750B Chip Enable/Disable

Component Selection

Power Inductor

It is recommended to use a 47 μ H or higher inductance to remain low output ripple voltage in most applications. Increasing the inductance will result in lower output ripple voltage. It is suggested to choose a lower DCR with a typical value less than 1 Ω to reduce the efficiency loss. Otherwise, the chosen inductor saturation current should be greater than its peak current with a typical value of 1A or higher in applications.

Schottky Diode

The diode breakdown voltage rating should be higher than the maximum output voltage. The diode current rating equal to or greater than 1A is suggested.

Input Capacitor

A low ESR ceramic capacitor, C_{IN}, is needed between the VIN and GND pins. Use ceramic capacitors with X5R or X7R dielectrics for their low ESRs and small temperature coefficients. For most applications, a 47 μ F capacitor will be a proper selection.

Output Capacitor

The output capacitor, C_{OUT}, selection is determined by the maximum allowable output voltage ripple. Use ceramic capacitors with X5R or X7R dielectrics for their low ESR characteristics. Capacitors in the range of 22 μ F to 100 μ F are a good starting point with an ESR of 0.1 Ω or less. It is usually suggested to use a 22 μ F capacitor in most applications.

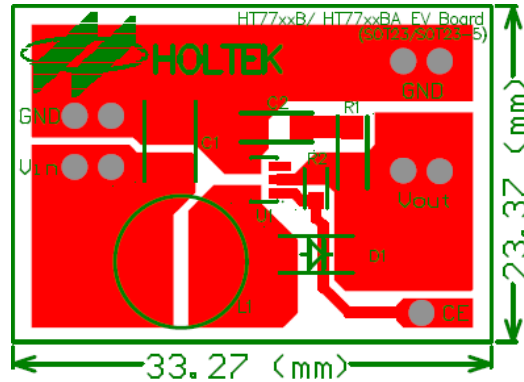
Ripple Improved Resistor with a No Load Condition

It is strongly recommended to add a ripple improved resistor, R₁, to keep the switching stability with a no load condition. It is recommended to set R₁ to 0.15 Ω . Note that this extra resistor improves the ripple performance when in a no load condition, but induces higher ripple voltage when the load is heavy.

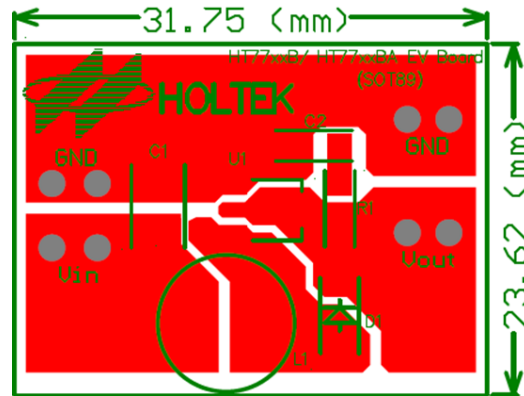
PCB Layout Suggestion

To reduce problems with conducted noise, there are some important points to note on the PCB layout.

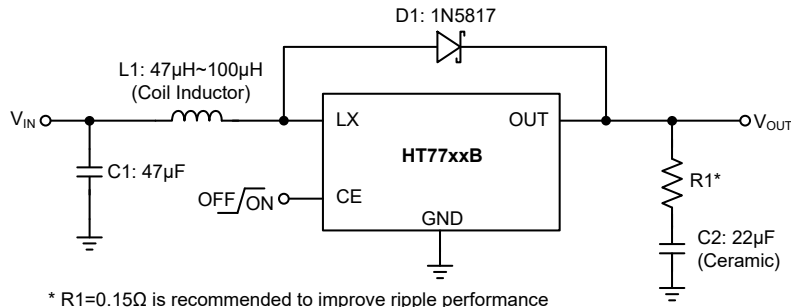
- The input bypass capacitor must be placed close to the VIN pin.
- The inductor, schottky diode and output capacitor trace should be as short as possible to reduce the conducted and radiated noise and increase overall efficiency.



SOT23/SOT23-5 PCB Layout Example



SOT89 PCB Layout Example



Thermal Consideration

The maximum power dissipation depends upon the thermal resistance of the IC package, PCB layout, rate of surrounding airflow and difference between the junction and ambient temperature. The maximum power dissipation can be calculated by the following formula:

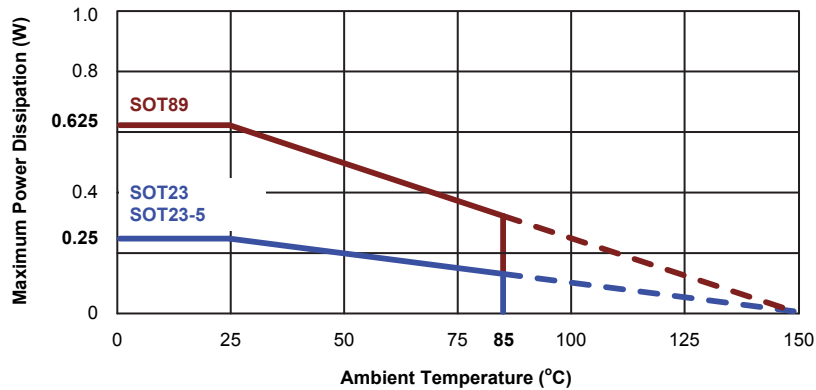
$$P_{D(MAX)} = (T_{J(MAX)} - T_a) / \theta_{JA} \dots \dots \dots (W)$$

Where $T_{J(MAX)}$ is the maximum junction temperature, T_a is the ambient temperature and θ_{JA} is the junction to ambient thermal resistance.

For maximum operating rating conditions, the maximum junction temperature is 150°C. However, it's recommended that the maximum junction temperature does not exceed 125°C during normal operation to maintain high reliability. The de-rating curve of the maximum power dissipation is show below:

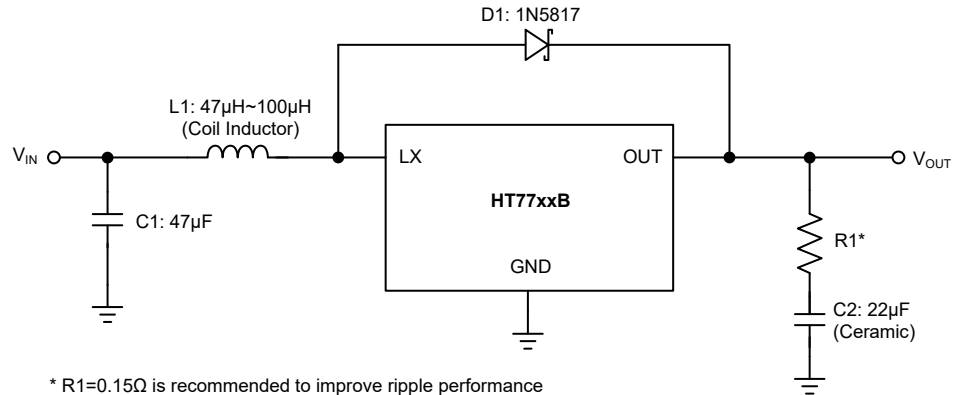
$$P_{D(MAX)} = (150^{\circ}C - 25^{\circ}C) / (500^{\circ}C/W) = 0.25W$$

For a fixed $T_{J(MAX)}$ of 150°C, the maximum power dissipation depends upon the operating ambient temperature and the package's thermal resistance, θ_{JA} . The de-rating curve below shows the effect of rising ambient temperature on the maximum recommended power dissipation.

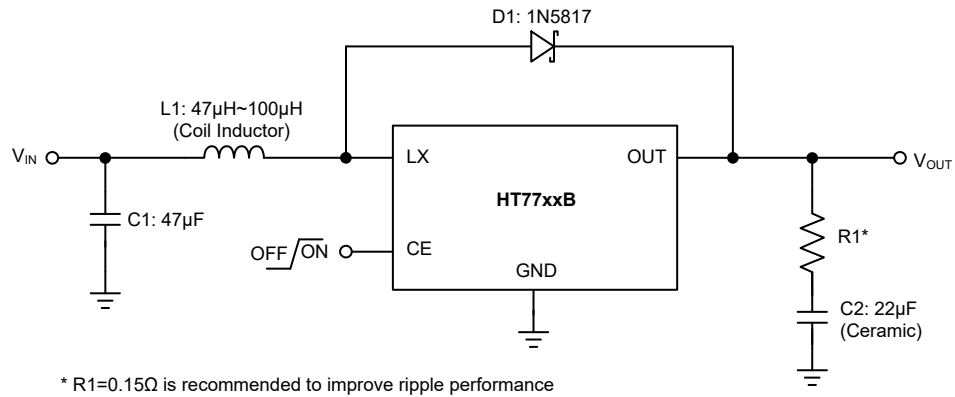


Application Circuits

Without CE Pin Application Circuits



With CE Pin Application Circuits



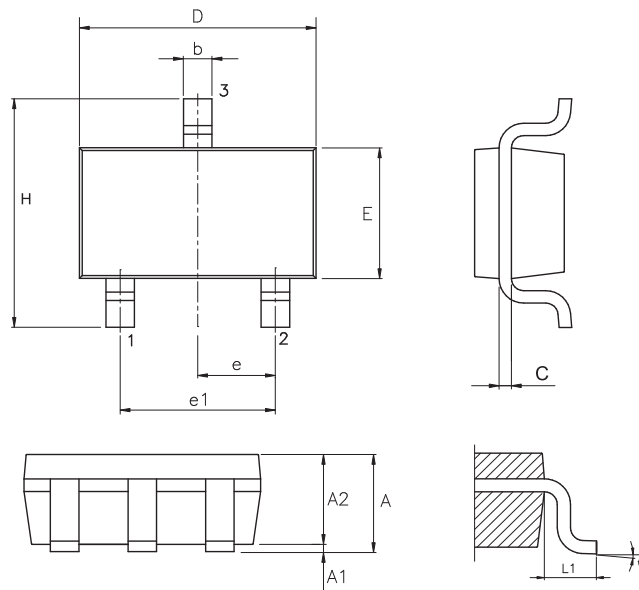
- Note: 1. When CE='0', the device internal circuits such as the bandgap reference, gain block and all feedback and control circuitry will be switched off.
 2. When CE='0', the output voltage, V_{OUT} , is almost equal to V_{IN} .
 3. If the CE pin is not used, it should be externally connected to the OUT pin.

Package Information

Note that the package information provided here is for consultation purposes only. As this information may be updated at regular intervals users are reminded to consult the [Holtek website](#) for the latest version of the [package information](#).

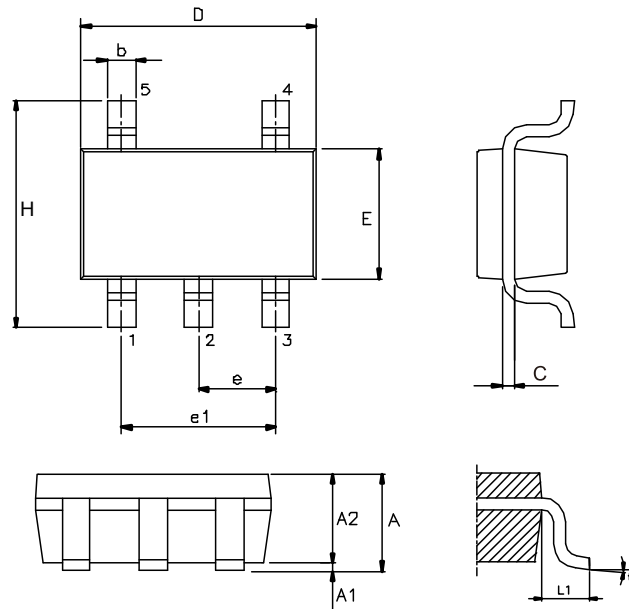
Additional supplementary information with regard to packaging is listed below. Click on the relevant section to be transferred to the relevant website page.

- Further Package Information (include Outline Dimensions, Product Tape and Reel Specifications)
- Packing Materials Information
- Carton information

3-pin SOT23 Outline Dimensions


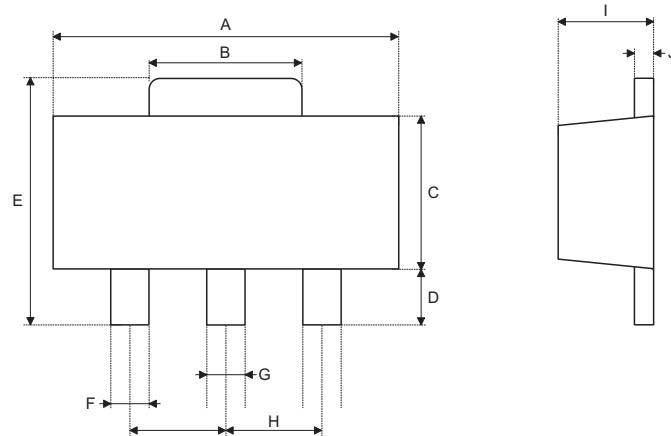
Symbol	Dimensions in inch		
	Min.	Nom.	Max.
A	—	—	0.057
A1	—	—	0.006
A2	0.035	0.045	0.051
b	0.012	—	0.020
C	0.003	—	0.009
D	—	0.114 BSC	—
E	—	0.063 BSC	—
e	—	0.037 BSC	—
e1	—	0.075 BSC	—
H	—	0.110 BSC	—
L1	—	0.024 BSC	—
θ	0°	—	8°

Symbol	Dimensions in mm		
	Min.	Nom.	Max.
A	—	—	1.45
A1	—	—	0.15
A2	0.90	1.15	1.30
b	0.30	—	0.50
C	0.08	—	0.22
D	—	2.90 BSC	—
E	—	1.60 BSC	—
e	—	0.95 BSC	—
e1	—	1.90 BSC	—
H	—	2.80 BSC	—
L1	—	0.60 BSC	—
θ	0°	—	8°

5-pin SOT23 Outline Dimensions


Symbol	Dimensions in inch		
	Min.	Nom.	Max.
A	—	—	0.057
A1	—	—	0.006
A2	0.035	0.045	0.051
b	0.012	—	0.020
C	0.003	—	0.009
D	—	0.114 BSC	—
E	—	0.063 BSC	—
e	—	0.037 BSC	—
e1	—	0.075 BSC	—
H	—	0.110 BSC	—
L1	—	0.024 BSC	—
θ	0°	—	8°

Symbol	Dimensions in mm		
	Min.	Nom.	Max.
A	—	—	1.45
A1	—	—	0.15
A2	0.90	1.15	1.30
b	0.30	—	0.50
C	0.08	—	0.22
D	—	2.90 BSC	—
E	—	1.60 BSC	—
e	—	0.95 BSC	—
e1	—	1.90 BSC	—
H	—	2.80 BSC	—
L1	—	0.60 BSC	—
θ	0°	—	8°

3-pin SOT89 Outline Dimensions


Symbol	Dimensions in inch		
	Min.	Nom.	Max.
A	0.173	—	0.185
B	0.053	—	0.072
C	0.090	—	0.106
D	0.031	—	0.047
E	0.155	—	0.173
F	0.014	—	0.019
G	0.017	—	0.022
H	—	0.059 BSC	—
I	0.055	—	0.063
J	0.014	—	0.017

Symbol	Dimensions in mm		
	Min.	Nom.	Max.
A	4.40	—	4.70
B	1.35	—	1.83
C	2.29	—	2.70
D	0.80	—	1.20
E	3.94	—	4.40
F	0.36	—	0.48
G	0.44	—	0.56
H	—	1.50 BSC	—
I	1.40	—	1.60
J	0.35	—	0.44

Copyright© 2018 by HOLTEK SEMICONDUCTOR INC.

The information appearing in this Data Sheet is believed to be accurate at the time of publication. However, Holtek assumes no responsibility arising from the use of the specifications described. The applications mentioned herein are used solely for the purpose of illustration and Holtek makes no warranty or representation that such applications will be suitable without further modification, nor recommends the use of its products for application that may present a risk to human life due to malfunction or otherwise. Holtek's products are not authorized for use as critical components in life support devices or systems. Holtek reserves the right to alter its products without prior notification. For the most up-to-date information, please visit our web site at <http://www.holtek.com>.

X-ON Electronics

Largest Supplier of Electrical and Electronic Components

Click to view similar products for [Isolated DC/DC Converters](#) category:

Click to view products by [Holtek](#) manufacturer:

Other Similar products are found below :

[FMD15.24G](#) [PSL486-7LR](#) [Q48T30020-NBB0](#) [18362](#) [JAHW100Y1](#) [SPB05C-12](#) [SQ24S15033-PS0S](#) [18952](#) [19-130041](#) [CE-1003](#) [CE-1004](#)
[RDS180245](#) [MAU228](#) [J80-0041NL](#) [DFC15U48D15](#) [XGS-1205](#) [NCT1000N040R050B](#) [SPB05B-15](#) [SPB05C-15](#) [L-DA20](#) [DCG40-5G](#)
[QME48T40033-PGB0](#) [AK1601-9RT](#) [DPA423R](#) [VI-R5022-EXWW](#) [PSC128-7iR](#) [RPS8-350ATX-XE](#) [DAS1004812](#) [PQA30-D24-S24-DH](#) [vi-](#)
[m13-cw-03](#) [VI-LN2-EW](#) [VI-PJW01-CZY](#) [CK2540-9ERT](#) [AK-1615-7R](#) [700DNC40-CON-KIT-8G](#) [350DNC40-CON-KIT-9G](#) [088-101348-G](#)
[VI-L52-EW](#) [VI-L53-CV](#) [PQA30-D48-S12-TH](#) [VI-L50-IY](#) [VI-LC63-EV](#) [AM2D-051212DZ](#) [24IBX15-50-0ZG](#) [HZZ01204-G](#) [SPU02L-09](#)
[SPU02M-09](#) [SPU02N-09](#) [UNO-PS/350-900DC/24DC/60W](#) [QUINT4-BUFFER/24DC/20](#)