

**White LED Step-up Charge Pump Converter**

---

**Features**

- Input voltage range: 2.8V to  $V_{OUT}$
- Driving current: 110mA (HT7936A), 150mA (HT7936B)
- Fixed output voltage: 5V (HT7936A), 4.5V (HT7936B)
- Oscillator frequency: 1MHz
- Soft start function, current limit, short circuit protection
- Small outline 6-pin SOT23 package

**Applications**

- Cellular phones
- PDAs
- DSCs
- Handheld devices
- White LED display backlighting

**General Description**

The HT7936A and HT7936B are charge-pump type DC-DC step-up converter devices, which can generate regulated fixed output voltages of 5.0V and 4.5V. Their high degree of functional integration requires only the addition of three external capacitors, namely a flying capacitor and an input and output capacitor, to implement a full step-up conversion function.

The devices have the additional benefit of an integrated soft start function to reduce the level of in-rush current

during device power on. The operating voltage range is from 2.8V to the full output voltage value,  $V_{OUT}$ .

To meet the demands of today's power sensitive applications, the devices, have a very low standby current value as well as the extra safety features of current limit and short circuit protection. This range of device features, supplied in 6-pin SOT23 package type, will ensure that these device will find excellent use in a wide range of DC-DC step-up converter applications.

**Selection Table**

Part No.	Output Voltage	Tolerance	Package	Marking
HT7936A	5.0V	±4%	SOT23-6	936A
HT7936B	4.5V	±4%	SOT23-6	936B

**Block Diagram**

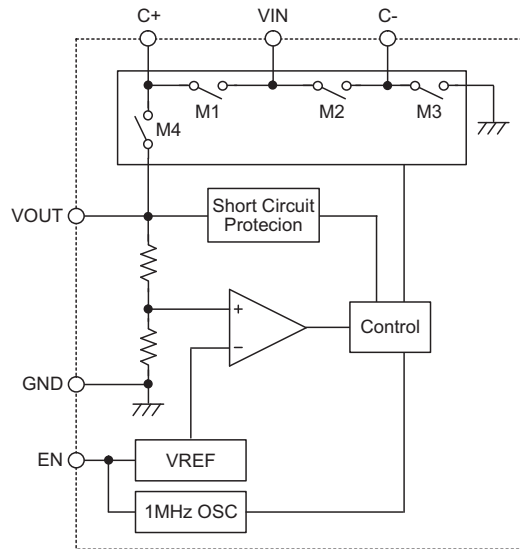

Note: During operation the following sequence occurs:  
 1. M1, M3 On / M2, M4 Off  
 2. M2, M4 On / M1, M3 Off

**Pin Assignment**

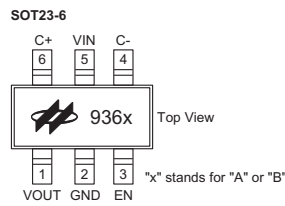

**Pin Description**

Pin No.	Pin Name	Description
1	VOUT	Regulated Output Voltage. $V_{OUT}$ should be bypassed with a $1\mu\text{F}$ to $10\mu\text{F}$ low ESR ceramic capacitor placed as close as possible to the pin for best performance.
2	GND	Ground. This pin is the voltage reference for the regulator output voltage.
3	EN	Device On/Off Control 1: Enable 0: Disable Pin must not be left floating.
4	C-	Capacitor Negative Pin. Flying capacitor negative terminal.
5	VIN	Input Supply Voltage. $V_{IN}$ should be bypassed with a $1\mu\text{F}$ to $10\mu\text{F}$ low ESR ceramic capacitor.
6	C+	Capacitor Positive Pin. Flying capacitor positive terminal.

**Absolute Maximum Ratings**

Input Supply Voltage.....6V      Other Pins Voltage .....6V  
 Operating Temperature Range .....-40°C to 85°C      Maximum Junction Temperature.....125°C

Note: These are stress ratings only. Stresses exceeding the range specified under "Absolute Maximum Ratings" may cause substantial damage to the device. Functional operation of this device at other conditions beyond those listed in the specification is not implied and prolonged exposure to extreme conditions may affect device reliability.

**Electrical Characteristics**

$V_{IN}=V_{EN}=3.7V$ ,  $C_{IN}=C_{PUMP}=C_{OUT}=1\mu F$ ,  $T_a=25^\circ C$ , unless otherwise specified.

Symbol	Parameter	Test Conditions	Min.	Typ.	Max.	Unit
$V_{IN}$	Input Supply Voltage	HT7936A	2.8	—	5.0	V
		HT7936B	2.8	—	4.5	V
$V_{OUT}$	Output Voltage	HT7936A, $V_{IN}>3.2V$ , $I_O\leq 110mA$	4.80	—	5.20	V
		HT7936B, $V_{IN}>3.2V$ , $I_O\leq 140mA$	4.32	—	4.68	V
$I_{SHDN}$	Shutdown Current	$V_{EN}=0$	—	0.1	1.0	$\mu A$
$I_Q$	Operation Current	—	—	2.0	4.0	mA
$I_O$	Output Current	HT7936A	110	—	—	mA
		HT7936B	150	—	—	mA
$I_{SHORT}$	Short Circuit Current	—	—	60	90	mA
$I_{LIMIT}$	Current Limit	—	—	370	500	mA
$f_{OSC}$	Switching Frequency	—	0.8	1.0	1.3	MHz
$V_{ENH}$	EN Pin Voltage High	$2.8V \leq V_{IN} \leq 5.0V$	1.5	—	—	V
$V_{ENL}$	EN Pin Voltage Low	$2.8V \leq V_{IN} \leq 5.0V$	—	—	0.4	V
$V_{RIPPLE}$	Output Ripple Voltage	$I_O=60mA$ , $C_{OUT}=2.2\mu F$	—	30	—	mV
$\eta$	Efficiency	HT7936A, $V_{IN}=3.0V$ , $I_O=50mA$	—	80	—	%
		HT7936B, $V_{IN}=2.8V$ , $I_O=70mA$	—	80	—	%

Note: Absolute maximum ratings indicate limits beyond which damage to the device may occur. Operating Ratings indicate conditions for which the device is intended to be functional, but do not guarantee specific performance limits. The guaranteed specifications apply only for the test conditions listed.

Specifications are production tested at  $T_a=25^\circ C$ . Specifications over  $-40^\circ C$  to  $+85^\circ C$  operating temperature range are assured by design.

## Functional Description

These DC-DC step-up converters can generate fixed level output voltages higher than their input supply voltage.

### Operation

Utilising a charge pump method with three external capacitors to store and transfer energy, the devices can transfer electrical energy from input to output at different voltage levels. Since the capacitors are not able to change their voltage level abruptly, the  $V_{OUT}/V_{IN}$  voltage ratio of  $V_{OUT}$  over  $V_{IN}$  is limited within a fixed range. Capacitive voltage conversion is obtained by the periodic switching of a capacitor. It first charges the capacitor  $C_{PUMP}$  by connecting it across a voltage source after which it is connected to the output. Referring to Figure.1, during the on state of the internal clock, M1 and M3 are closed, M2 and M4 are opened, which charges  $C_{PUMP}$  to a  $V_{IN}$  level. During the off state of the internal clock, M2 and M4 are closed, M1 and M3 are opened, which transfers the energy to the output. The output voltage is therefore  $V_{IN}$  plus  $V_{CPUMP}$ , which is in effect equal to  $2V_{IN}$ .

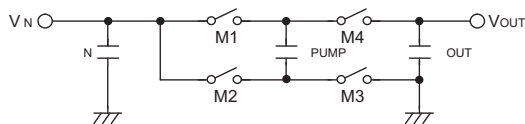

Figure.1

### Shutdown

The devices can be shutdown by setting the EN input pin to a low level. In the shutdown mode, the output is disconnected from the input. The input current will reduce to an extremely low level as most of the internal circuitry is inactive. As the EN pin is a high impedance input, it must not be allowed to float.

### Short Circuit Protection

The devices contain integrated short circuit protection circuits with current limiting protection. During a short circuit condition, the output current is automatically limited to a typical value of approximately 60mA. If the fault does not clear itself, the protect operation will repeat continuously. This protection feature allows the devices to operate indefinitely under short circuit conditions without damaging the device.

### Capacitor Selection

Careful selection of the three external capacitors  $C_{IN}$ ,  $C_{OUT}$  and  $C_{PUMP}$  is important because they will affect ramp-up time, output ripple and transient performance. Optimum performance will be obtained when low ESR ( $<100m\Omega$ ) ceramic capacitors are used for  $C_{IN}$  and  $C_{OUT}$  and  $C_{PUMP}$ .

In general, a low ESR may be defined as less than  $100m\Omega$ . In all cases, X7R or X5R dielectrics are recommended. For certain applications, low ESR Tantalum capacitors may be substituted, however optimum output ripple performance may not be attainable. Aluminum electrolytic capacitors are not recommended for use with these devices due to their inherent high ESR characteristics.

In general the  $C_{IN}$ ,  $C_{OUT}$  and  $C_{PUMP}$  capacitors may range from  $1\mu F$  to  $10\mu F$  for heavy output load conditions. If the  $C_{PUMP}$  capacitor is increased, then  $C_{OUT}$  should also be increased by the same ratio to minimise output ripple. Lowering the values of  $C_{IN}$ ,  $C_{OUT}$  and  $C_{PUMP}$  may decrease the ramp-up time of  $V_{OUT}$ , but it will inversely increase the output ripple.

### Efficiency

The efficiency of the charge pump regulator varies with the output voltage type, the applied input voltage, the load current and the internal operation mode of the device.

The approximate device efficiency is given by:

$$\begin{aligned} \eta(\%) &= \frac{P_{OUT}}{P_{IN}} \times 100 \\ &= \frac{V_{OUT} \times I_{OUT}}{V_{IN} \times 2I_{OUT}} \times 100 \\ &= \frac{V_{OUT}}{2V_{IN}} \times 100 \text{ (X2 Charge Pump Operation Mode)} \end{aligned}$$

Due to internal switching losses and IC quiescent current consumption, the actual measured efficiency will decrease.

Typical Operating Characteristics

For HT7936A,  $C_{IN}=C_{OUT}=2.2\mu F$ ,  $C_{PUMP}=0.22\mu F$ ,  $T_a=25^\circ C$ , unless otherwise specified

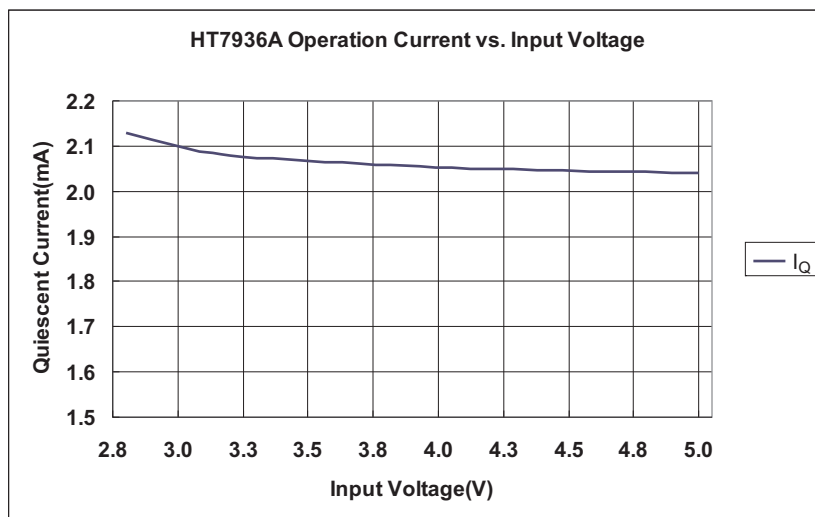
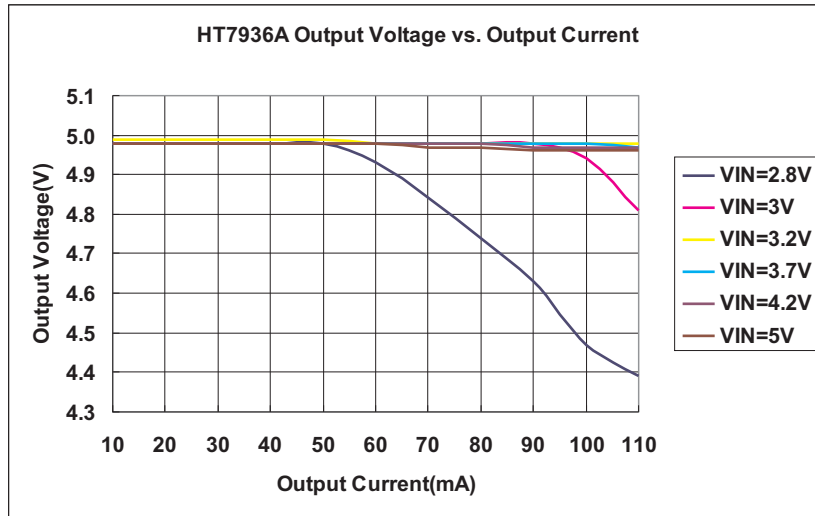

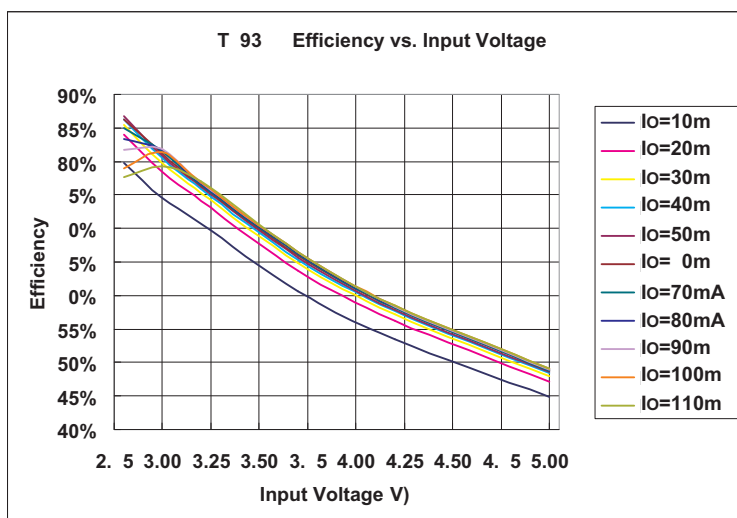
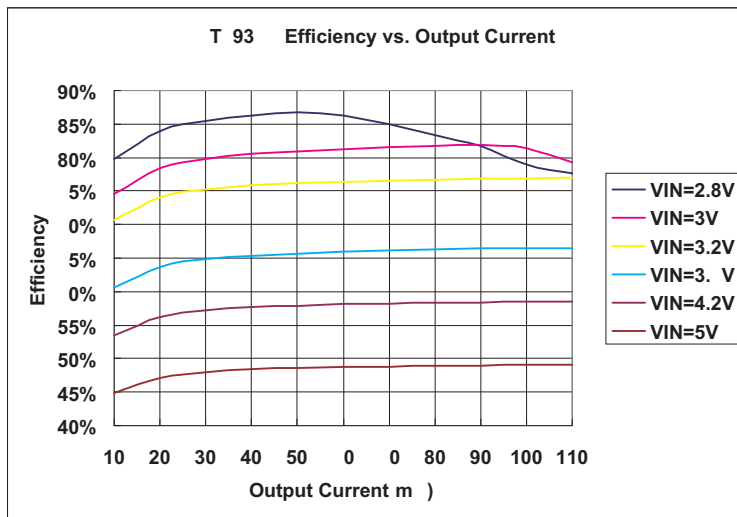
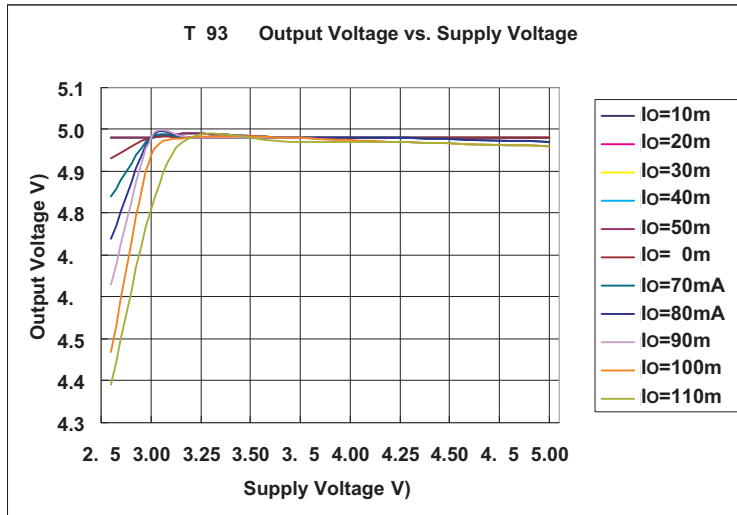

For HT7936B,  $C_{IN}=C_{OUT}=2.2\mu F$ ,  $C_{PUMP}=0.22\mu F$ ,  $T_a=25^\circ C$ , unless otherwise specified

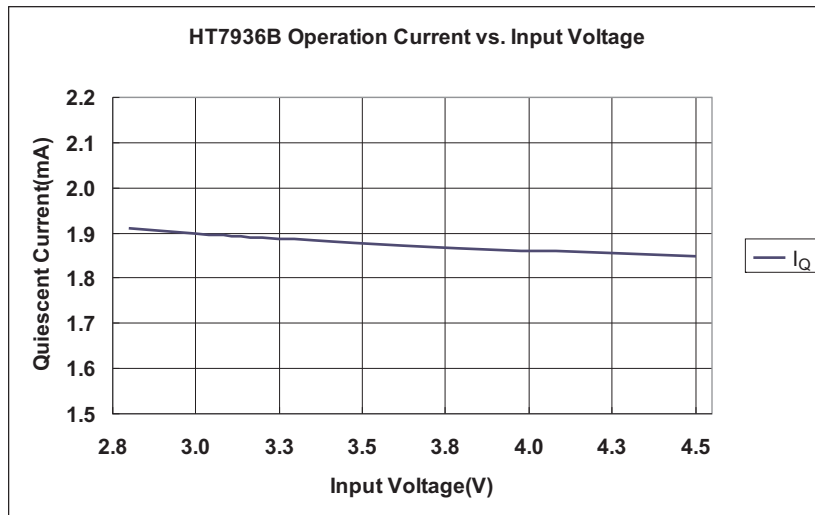
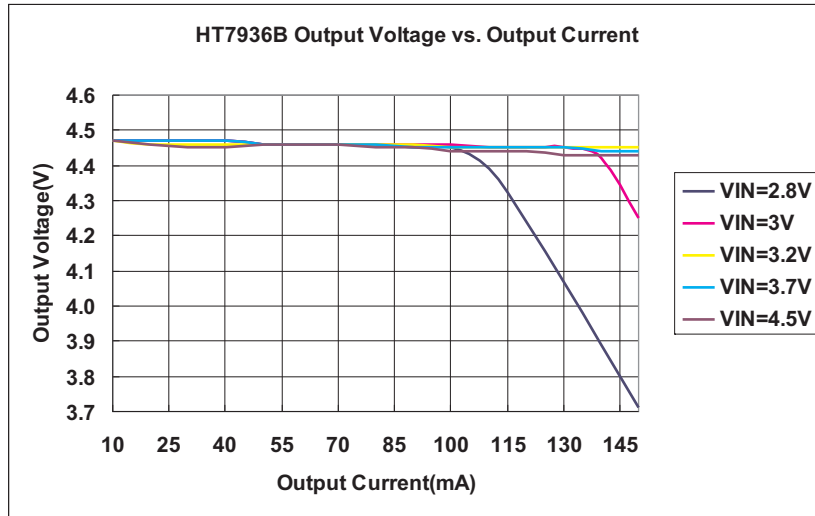

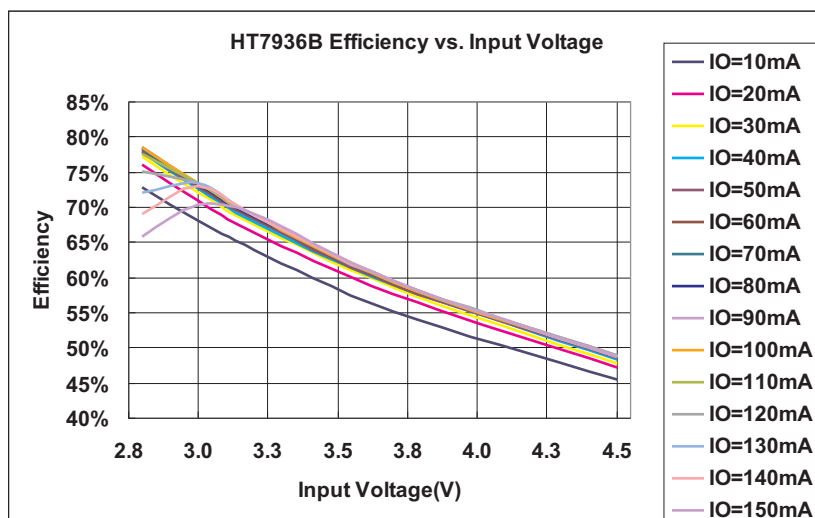
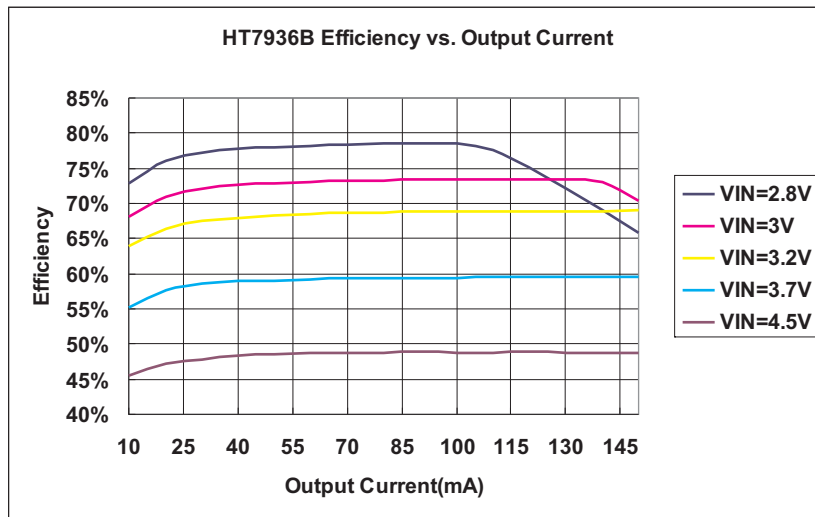
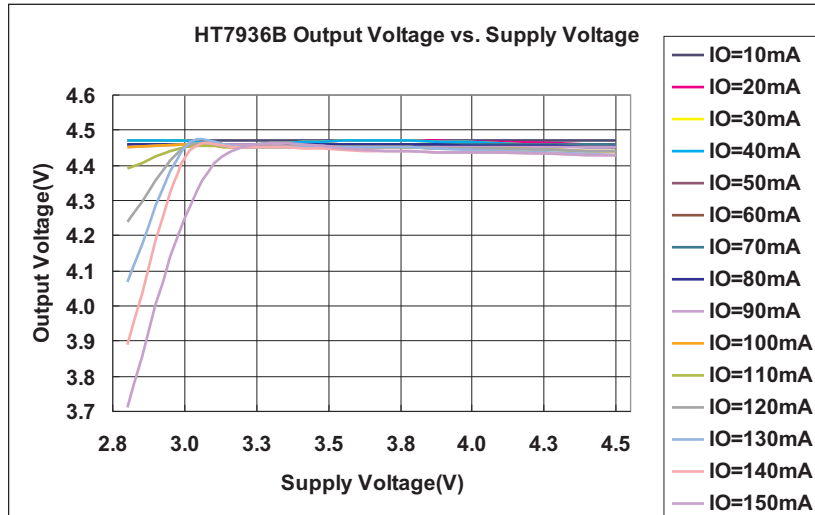



Inrush Current

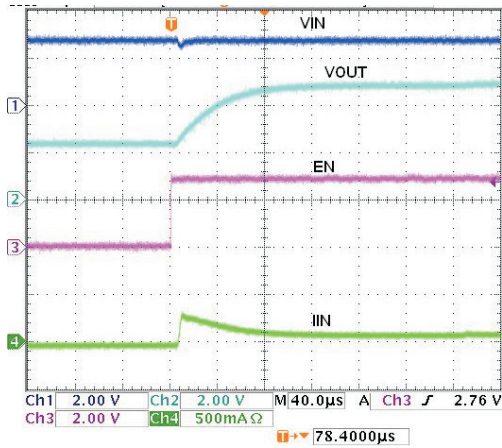

HT7936A  $V_{IN}=2.8V$ ,  $C_{IN}=C_{OUT}=2.2\mu F$ ,  
 $C_{PUMP}=0.22\mu F$

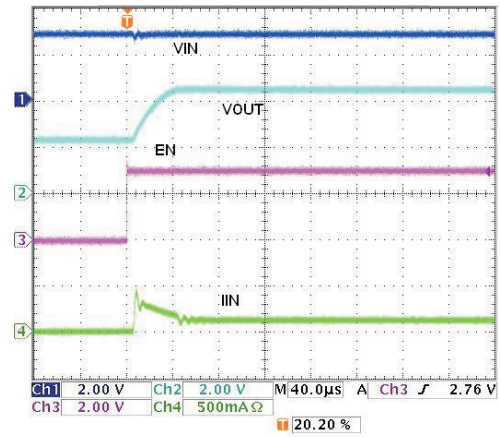

HT7936B  $V_{IN}=2.8V$ ,  $C_{IN}=C_{OUT}=2.2\mu F$ ,  
 $C_{PUMP}=0.22\mu F$

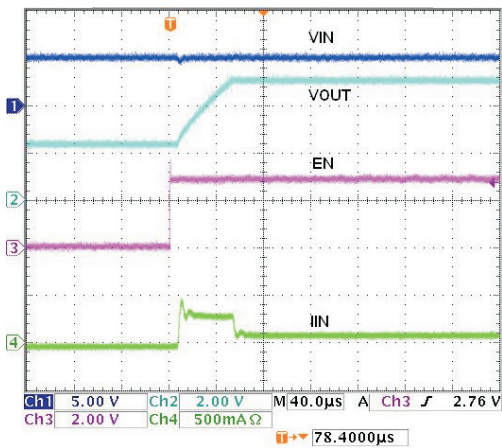

HT7936A  $V_{IN}=5.0V$ ,  $C_{IN}=C_{OUT}=2.2\mu F$ ,  
 $C_{PUMP}=0.22\mu F$

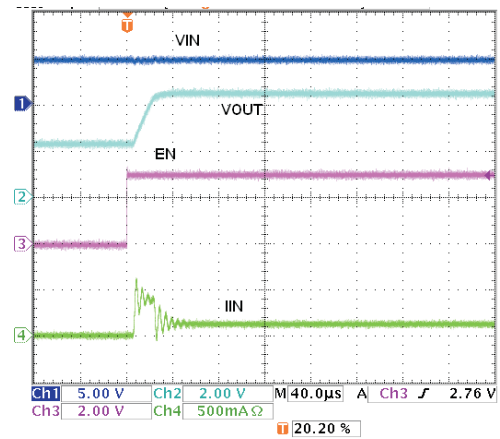

HT7936B  $V_{IN}=4.5V$ ,  $C_{IN}=C_{OUT}=2.2\mu F$ ,  
 $C_{PUMP}=0.22\mu F$

Normal Operation

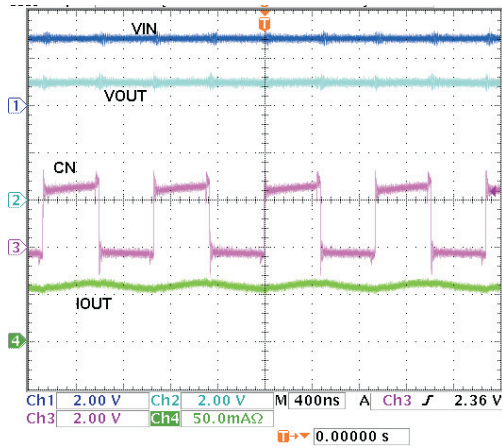

HT7936A  $V_{IN}=2.8V$ ,  $C_{IN}=C_{OUT}=2.2\mu F$ ,  
 $C_{PUMP}=0.22\mu F$

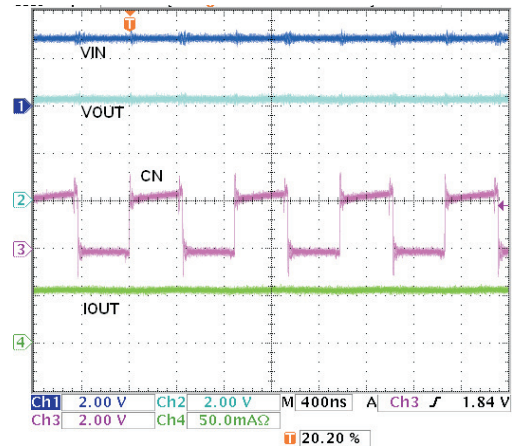

HT7936B  $V_{IN}=2.8V$ ,  $C_{IN}=C_{OUT}=2.2\mu F$ ,  
 $C_{PUMP}=0.22\mu F$

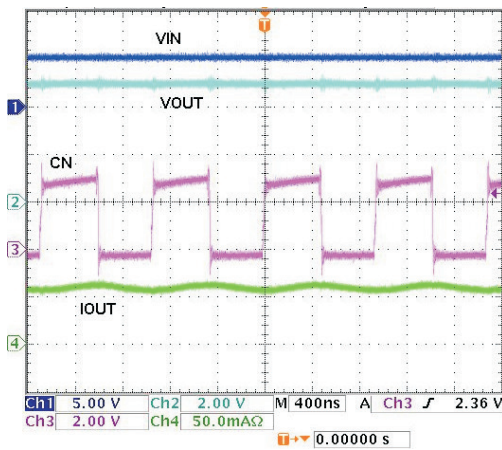

HT7936A  $V_{IN}=5.0V$ ,  $C_{IN}=C_{OUT}=2.2\mu F$ ,  
 $C_{PUMP}=0.22\mu F$

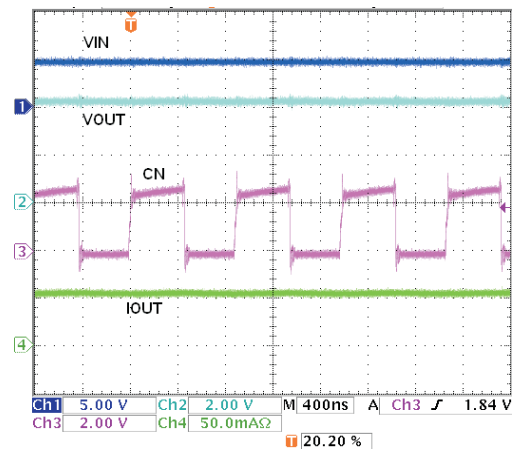

HT7936B  $V_{IN}=4.5V$ ,  $C_{IN}=C_{OUT}=2.2\mu F$ ,  
 $C_{PUMP}=0.22\mu F$

Dimming Operation

HT7936A, Refer to Figure.2

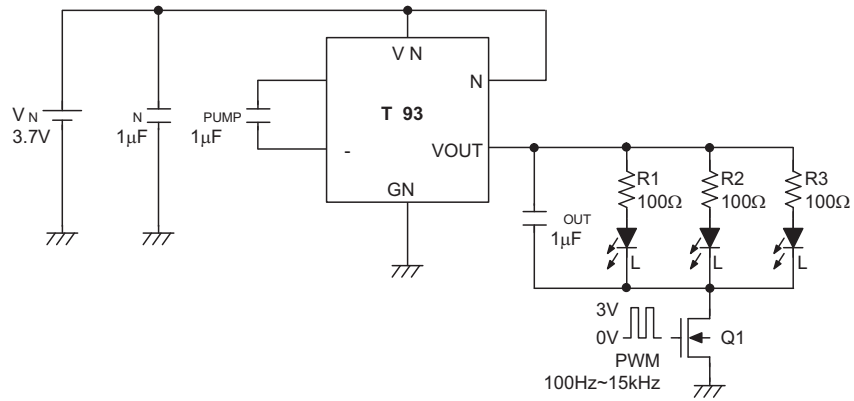
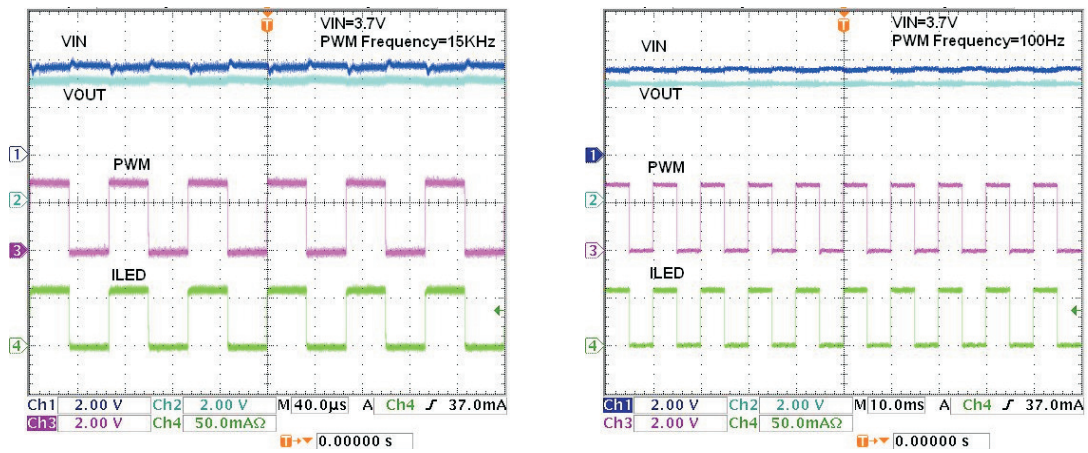

Figure.2

HT7936A, Refer to Figure.3

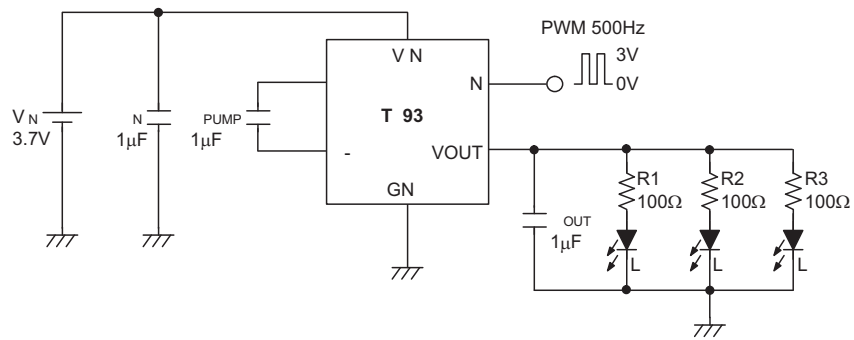
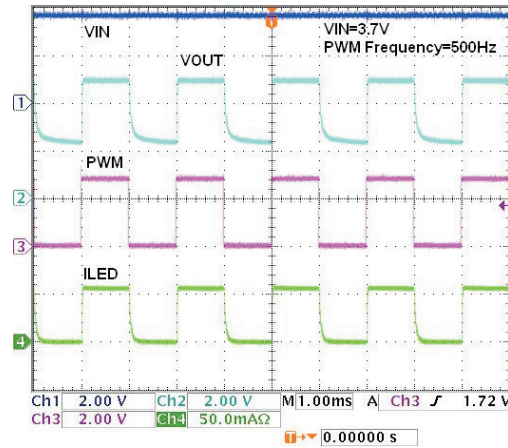
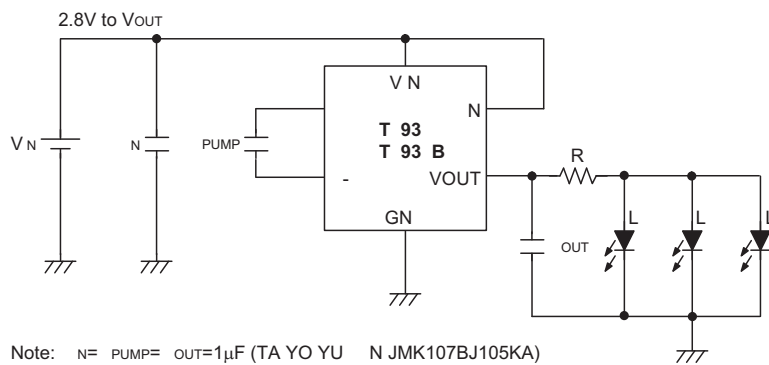

Figure.3

Application Circuits



Note: N= PUMP= OUT=1μF (TA YO YU N JMK107BJ105KA)

**Package Information**

Note that the package information provided here is for consultation purposes only. As this information may be updated at regular intervals users are reminded to consult the [Holtek website](#) for the latest version of the [package information](#).

Additional supplementary information with regard to packaging is listed below. Click on the relevant section to be transferred to the relevant website page.

- [Further Package Information \(include Outline Dimensions, Product Tape and Reel Specifications\)](#)
- [Packing Materials Information](#)
- [Carton Information](#)

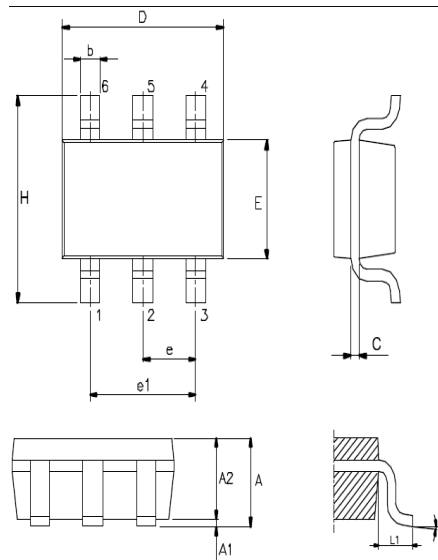
**6-pin SOT23 Outline Dimensions**

Symbol	Dimensions in inch		
	Min.	Nom.	Max.
A	—	—	0.057
A1	—	—	0.006
A2	0.035	0.045	0.051
b	0.012	—	0.020
C	0.003	—	0.009
D	—	0.114 BSC	—
E	—	0.063 BSC	—
e	—	0.037 BSC	—
E1	—	0.075 BSC	—
H	—	0.110 BSC	—
L	—	0.024 BSC	—
θ	0°	—	8°

Symbol	Dimensions in mm		
	Min.	Nom.	Max.
A	—	—	1.45
A1	—	—	0.15
A2	0.90	1.15	1.30
b	0.30	—	0.50
C	0.08	—	0.22
D	—	2.90 BSC	—
E	—	1.60 BSC	—
e	—	0.95 BSC	—
e1	—	1.90 BSC	—
H	—	2.80 BSC	—
L	—	0.60 BSC	—
θ	0°	—	8°

Copyright © 2018 by HOLTEK SEMICONDUCTOR INC.

The information appearing in this Data Sheet is believed to be accurate at the time of publication. However, Holtek assumes no responsibility arising from the use of the specifications described. The applications mentioned herein are used solely for the purpose of illustration and Holtek makes no warranty or representation that such applications will be suitable without further modification, nor recommends the use of its products for application that may present a risk to human life due to malfunction or otherwise. Holtek's products are not authorized for use as critical components in life support devices or systems. Holtek reserves the right to alter its products without prior notification. For the most up-to-date information, please visit our web site at <http://www.holtek.com.tw>.

## X-ON Electronics

Largest Supplier of Electrical and Electronic Components

*Click to view similar products for [Isolated DC/DC Converters](#) category:*

*Click to view products by [Holtek](#) manufacturer:*

Other Similar products are found below :

[FMD15.24G](#) [PSL486-7LR](#) [Q48T30020-NBB0](#) [18362](#) [JAHW100Y1](#) [SPB05C-12](#) [SQ24S15033-PS0S](#) [18952](#) [19-130041](#) [CE-1003](#) [CE-1004](#)  
[RDS180245](#) [MAU228](#) [J80-0041NL](#) [DFC15U48D15](#) [XGS-1205](#) [NCT1000N040R050B](#) [SPB05B-15](#) [SPB05C-15](#) [L-DA20](#) [DCG40-5G](#)  
[QME48T40033-PGB0](#) [AK1601-9RT](#) [DPA423R](#) [VI-R5022-EXWW](#) [PSC128-7iR](#) [RPS8-350ATX-XE](#) [DAS1004812](#) [PQA30-D24-S24-DH](#) [vi-](#)  
[m13-cw-03](#) [VI-LN2-EW](#) [VI-PJW01-CZY](#) [CK2540-9ERT](#) [AK-1615-7R](#) [700DNC40-CON-KIT-8G](#) [350DNC40-CON-KIT-9G](#) [088-101348-G](#)  
[VI-L52-EW](#) [VI-L53-CV](#) [PQA30-D48-S12-TH](#) [VI-L50-IY](#) [VI-LC63-EV](#) [AM2D-051212DZ](#) [24IBX15-50-0ZG](#) [HZZ01204-G](#) [SPU02L-09](#)  
[SPU02M-09](#) [SPU02N-09](#) [UNO-PS/350-900DC/24DC/60W](#) [QUINT4-BUFFER/24DC/20](#)