

Features

- Integrated high power boost DC-DC controller
- Wide input voltage range from 9V to 30V
- High Voltage Gate-Drive provides lower $R_{DS(ON)}$ and higher efficiencies
- Dimming frequency from 100Hz to 1kHz
- 0.3V LED feedback current sensing voltage with $\pm 3\%$ tolerance
- Device protection features include:
Soft-start, OCP, UVLO, OVP, OTP and output short protection – OSP
- LED protection: LED Open/Short Protection
- Package type: 8-pin SOP

General Description

The HT7963 is a high efficiency boost converter with a fixed oscillator frequency for LED backlighting and LED lighting application. The white LED current is setup using an external current setting resistor, which has a low feed-back voltage of only 0.3V. The DIM input allows a wide range of dimming control for LED backlighting or LED lighting. The device offers a full range of protection functions such as power MOSFET over current protection (OCP), IC power supply under voltage lockout (UVLO), over-voltage protection (OVP), output voltage short circuit protection (OSP) and over temperature protection (OTP).

Applications

- LED Backlighting for LCD TV/Monitor
- LED lighting

Typical Application Circuit

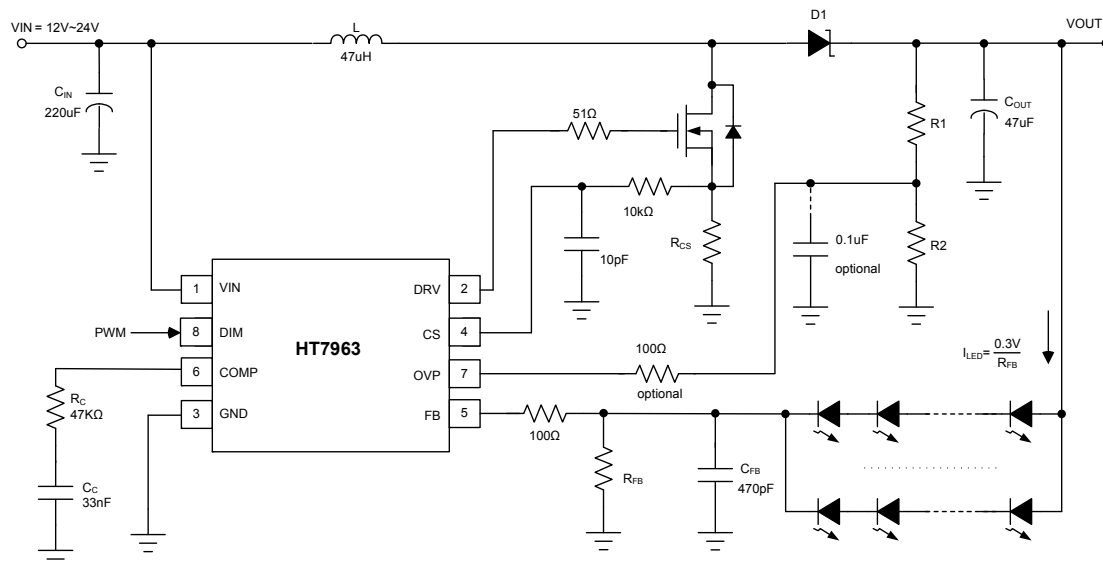

Note: The V_{OUT}/V_{IN} ratio is suggested to be lower than 5 to gain better dimming linearity.

Block Diagram

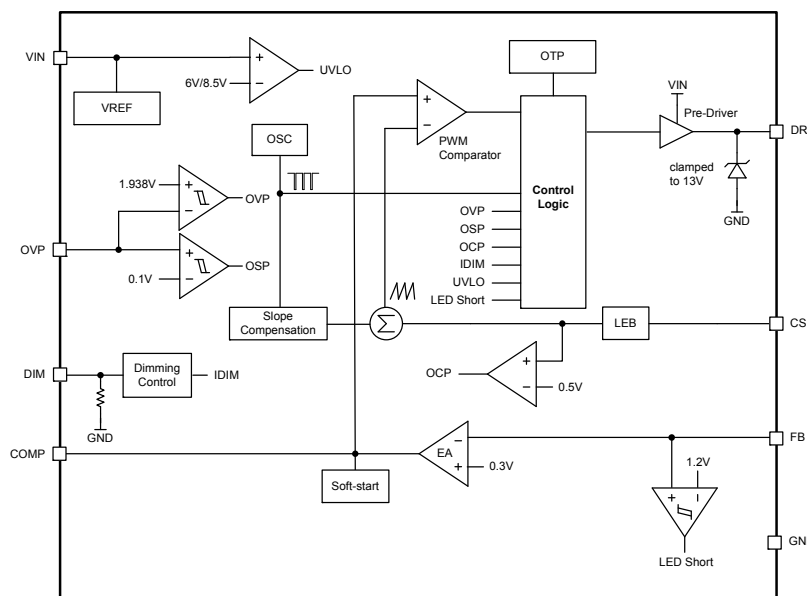

Pin Assignment

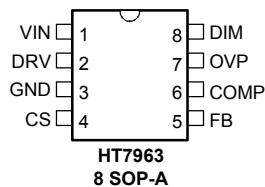

Pin Description

Pin Order	Name	Type	Pin Discription
1	VIN	P	Power Supply
2	DRV	O	Boost Converter Gate Drive Output
3	GND	G	Ground Terminal
4	CS	I	Boost Converter Current Sense Input
5	FB	I	LED Current Feedback Input
6	COMP	I/O	Boost Converter Loop Compensation
7	OVP	I	Over Voltage Protection Input – setup using resistor divider
8	DIM	I	External PWM Dimming Control / Enable Control

Absolute Maximum Ratings

Parameter	Value	Unit
VIN, DRV, CS, FB and OVP	-0.3 to 33	V
GND	+/-0.3	V
DIM and COMP	-0.3 to +7.0	V
Operating Temperature Range	-40 to +85	°C
Maximum Junction Temperature	+160	°C

Recommended Operating Range

Parameter	Value	Unit
V _{IN}	9~30	V
CS, OVP and FB	≤30	V
DRV (Internal Voltage Clamped)	13	V
DIM and COMP	0~5.5	V
Dimming Frequency	DC to 1000	Hz
Dimming Duty Cycle	1 to 100	%
Operating Junction Temperature	≤125	°C

Note that Absolute Maximum Ratings indicate limitations beyond which damage to the device may occur. Recommended Operating Ratings indicate conditions for which the device is intended to be functional, but do not guarantee specified performance limits.

Electrical Characteristics

V_{IN}=12V and Ta=25°C, unless otherwise specified

Symbol	Parameter	Test Condition	Min.	Typ.	Max.	Unit
Supply Voltage						
V _{IN}	Input Voltage	V _{IN}	9	—	30	V
I _{CC1}	Operating Current	DIM=5V	—	2.5	3	mA
I _{CC2}	Standby Current	DIM=0V	—	500	650	μA
I _{SHD}	Shutdown Current	DIM=0V, over 50ms	—	35	50	μA
Dimming						
V _{DIM_LH}	DIM High Threshold	V _{IN} =9V to 30V	—	—	2.4	V
V _{DIM_HL}	DIM Low Threshold	V _{IN} =9V to 30V	0.6	—	—	V
R _{PD_DIM}	DIM Internal Pull Down Resistance	—	—	500	—	kΩ
f _{DIM}	Dimming Frequency	DIM pin	100	—	1000	Hz
f _{DUTY}	Dimming Duty Cycle	DIM pin	0	—	100	%
T _{SHD}	Shutdown Mode Entry Period	DIM=0V (Figure1)	—	50	—	ms
T _{RT}	Recovery Time from Shutdown Mode	DIM from "L" to "H" (Figure1)	—	30	—	ms
Boost Converter						
f _{SW}	Switching Frequency	—	175	200	225	kHz
D _{MAX}	Maximum Duty Cycle	—	—	95	97.5	%
V _{DRV(CLAMP)}	DRV Clamp Voltage	V _{IN} =24V	—	13	14.5	V
t _{r_DRV}	DRV Rise Time	C=0.5nF	—	40	—	ns
t _{f_DRV}	DRV Falling Time	C=0.5nF	—	20	—	ns
t _{LEB}	LEB Time of Current Sense	Lead-Edge Blanking	—	200	—	ns
Protections						
SR _{SS}	Soft Start Slope	SS	—	200	—	mV/ms
V _{OVP}	Output Over Voltage Detect Threshold	V _{OVP}	—	1.938	—	V
ERR _{OVP}	Tolerance of V _{OVP}	—	-5.0	—	+5.0	%
V _{UVLO+}	Input Supply Turn ON Level	UVLO (on)	—	—	8.5	V
V _{UVLO-}	Input Supply Turn OFF Level	UVLO (off)	6	—	—	V
V _{OSP}	Output Short Circuit Threshold	OSP	0.05	0.1	—	V
V _{OCP}	Over Current Protection Threshold	OCP, V(CS)	—	0.5	0.65	V
V _{SHORT}	LED Short Protection Threshold	LED Short, V(FB)	—	1.2	1.56	V
V _{SHORT_HYS}	LED Short Protection Hysteresis	—	—	70	—	mV
TH _{SHD}	Thermal Shutdown	OTP	—	150	—	°C

Symbol	Parameter	Test Condition	Min.	Typ.	Max.	Unit
TH _{SHD_HYS}	Hysteretic Temperature	—	—	30	—	°C
LED Output Current						
V _{FB}	Current Feedback Sensing Voltage	V _{FB}	—	0.3	—	V
ERR _{FB}	Tolerance of V _{FB}	—	-3.0	—	+3.0	%

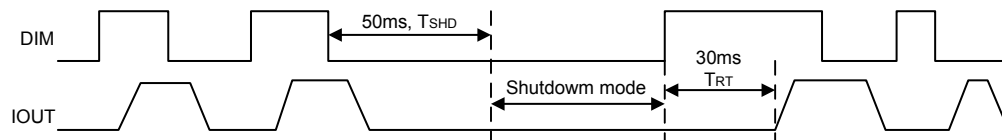

Figure1

Functional Description

General Operation

The device is an LED driver operating as a DC-DC boost converter in a constant frequency mode. It implements a peak current mode control and has an internal amplifier to accurately control the output current over conditions of wide input voltage and varying load.

Soft Start – SS

The device has dedicated protection circuitry running during normal operation. The Soft Start function is set to have an internal time of around 5ms and is used to prevent a large inrush current during the power-on period.

Output Gate Drive Stage

A CMOS buffer output stage is included to drive a power MOSFET directly. The output voltage is clamped at 13V to protect the MOSFET gate even when the VCC voltage is higher than 13V.

Input Under Voltage Lockout – UVLO

The device contains an input under-voltage lockout circuit. The purpose of the UVLO circuit is to ensure that the input voltage is high enough for reliable operation. When the input voltage falls below the under voltage threshold, the external FET switch is switched off. If the input voltage rises beyond the under voltage lockout hysteresis value, the device will restart. The UVLO threshold is set below the minimum input voltage of 6V to avoid any transient VIN drops under the UVLO threshold which may cause the converter to switch off.

Current Limiting

The device has a cycle-by-cycle current limit to protect the external power MOSFET. If the inductor current reaches the current limit threshold, which is when the CS pin voltage is greater than 0.5V, the external MOSFET will be switched off. The R_{CS} value can be calculated from the following formula:

$$I_{LIMIT} = \frac{0.5V}{R_{CS}}$$

Dimming Control

The LED brightness control is implemented using a PWM signal on the DIM pin. The PWM duty cycle is proportional to the dimming value. The device can apply an external PWM signal on the DIM pin with a frequency range from 100Hz to 1kHz with the required high/low ratio.

Output Over Voltage Protection – OVP

The device includes an over-voltage protection function. In abnormal conditions, the output voltage may exceed its maximum voltage rating, possibly damaging external components and the LEDs. Protection circuitry turns off the power MOSFET and shuts down the device as soon as the output voltage exceeds the V_{OVP} threshold. As a result, the output voltage falls to the level of the input supply voltage. The device remains in the shutdown mode until the power is recycled. The V_{OUT_OVP} value can be calculated from the following formula:

$$V_{OUT_OVP} = 1.938V \times \frac{R_1 + R_2}{R_2}$$

Output Short Protection – OSP

An output short condition is detected by the voltage on pin OVP. In the period during the fault, if the voltage on the OVP pin drops by less than a threshold of around 0.1V, then the output short protection will be activated and the power MOSFET will be switched off.

Thermal Shutdown

A thermal shutdown function is implemented to prevent damage due to excessive heat and power dissipation. Typically the thermal shutdown threshold is 150°C. When the thermal shutdown is triggered the device stops switching until the temperature falls below a typical temperature of 125°C, after which the device will again begin operation.

Component Selection Guide

Inductor

The selected inductor should have a saturation current that meets the maximum peak current of the converter. Another important inductor parameter is the dc resistance. Lower dc resistance values results in higher converter efficiencies. For most applications, the inductor value can be obtained as below.

$$L = \frac{V_{IN} \times (V_{OUT} - V_{IN})}{\Delta I_L \times f_{SW} \times V_{OUT}}$$

A higher value of ripple current reduces the inductance value, but increases the conductance loss, core loss and current stress for the inductor and switching devices. A suggested choice is for the inductor ripple current to be 30% of the maximum load current. This requires that the inductor saturation current be above $I_{L(PEAK)}$.

$$I_{IN(MAX)} = \frac{V_{OUT} \times I_{OUT(MAX)}}{V_{IN} \times \eta}$$

$$\Delta I_L = 30\% \times I_{IN(MAX)}$$

$$I_{L(PEAK)} = I_{IN(MAX)} + \frac{1}{2} \Delta I_L$$

$I_{OUT(MAX)}$ is the maximum load current, ΔI_L is the peak-to-peak inductor ripple current, η is the converter efficiency, f_{SW} is the switching frequency and $I_{L(PEAK)}$ is the peak inductor current.

Schottky Diode

It is recommended to use a Schottky diode with low forward voltage to minimise the power dissipation and therefore to maximise the converter efficiency. The breakdown voltage rating of the diode should be higher than the maximum output voltage. The average and peak current rating must be greater than the maximum output current and peak inductor current to ensure the best reliability in most applications.

MOSFET

It is recommended to use a MOSFET with small on resistance to minimise the power dissipation and therefore to maximise the converter efficiency. MOSFETs with small gate capacitance values need to be selected to have high-speed switching. The maximum voltage rating of the MOSFET should be higher than the sum of V_{OUT} and the rectifying diode V_F . The maximum current rating must be greater than the over current protection setting and peak inductor current to ensure the best reliability in most applications.

Input Capacitor

A low ESR ceramic capacitor is required to be connected between the VIN and GND pins. Use ceramic capacitors with X5R or X7R dielectrics for their low ESRs and small temperature coefficients. This capacitor must be connected very close to the VIN pin and the inductor with short traces for good noise performance.

Output Capacitor

A low ESR ceramic capacitor is suggested for use here as it will result in lower output ripple voltages. The selection of output capacitor is driven by the maximum allowable output voltage ripple. A ceramic capacitor with a low ESR value will provide the lowest voltage ripple and is therefore recommended. A capacitance in the range of 33µF to 47µF is sufficient. Capacitor voltage ratings needs to be selected to have an adequate margin against the highest output voltage.

LED Current Selection

The LED current is controlled by the current sense feedback resistor R_{FB} , The current sense feedback reference voltage (V_{FB}) is **0.3V**. In order to obtain accurate LED currents, precision resistors are the preferred type with a 1% tolerance. The LED current (I_{LED}) can be calculated from the following formula.

$$I_{LED} = \frac{V_{FB}}{R_{FB}} = \frac{0.3V}{R_{FB}}$$

CS Pin and FB Pin RC Filter

Whether an RC low pass filter is employed or not depends upon the design layout and must be considered on a case-by-case basis.

Layout Considerations

Circuit board layout is a very important consideration for switching regulators if they are to function properly. Poor circuit layout may result in related noise problems. In order to minimise EMI and switching noise, the following guidelines should be adhered to:

- All tracks should be as wide as possible
- The input and output capacitors, C_{IN} and C_{OUT} , should be placed close to the VIN, VOUT and GND pins
- The Schottky diode, D1, and inductor, L, must be placed close to the power MOSFET drain
- Feedback resistor, R_{FB} , must be placed close to the FB and GND pins
- A full ground plane is always helpful for better EMI performance

A recommended PCB layout with component locations is shown below.

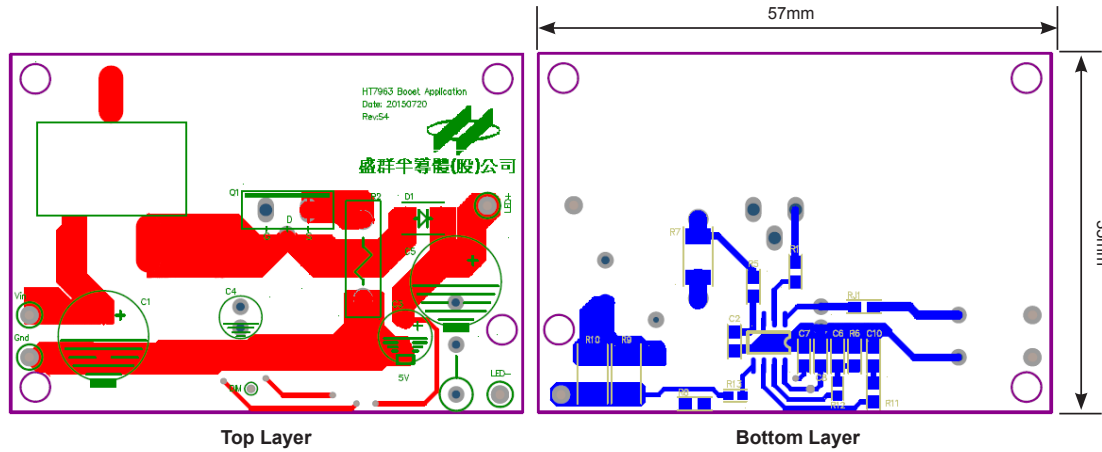

Typical Performance Characteristics

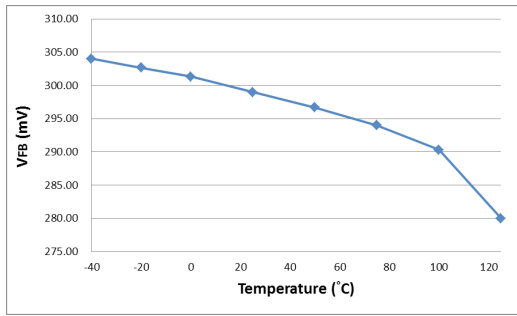

Fig.2 Feedback Voltage VS Temperature

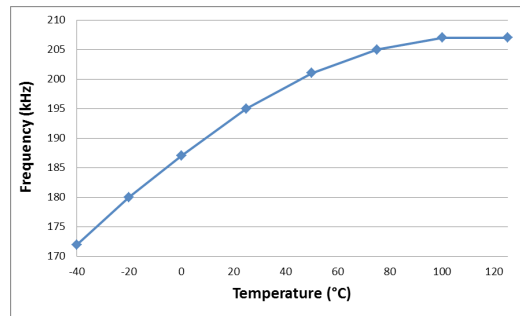

Fig.5 Frequency VS Temperature

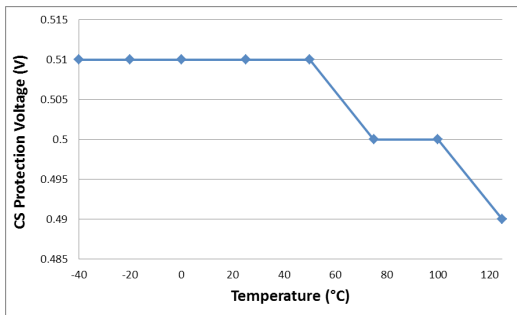

Fig.3 CS Protection Voltage VS Temperature

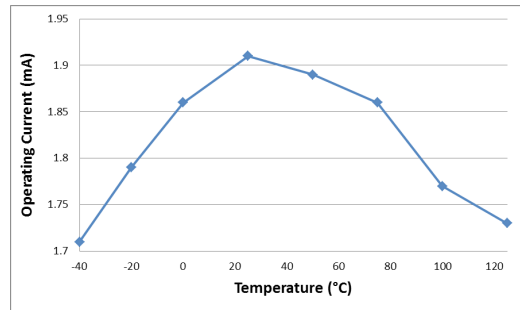

Fig.6 Operating Current VS Temperature

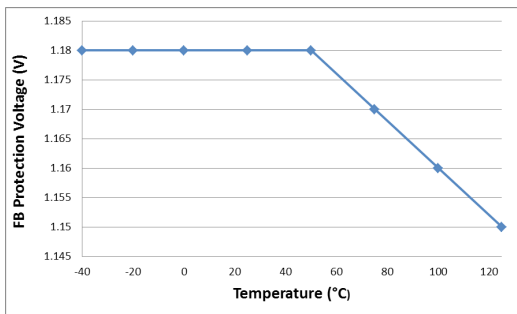

Fig.4 FB Protection Voltage VS Temperature

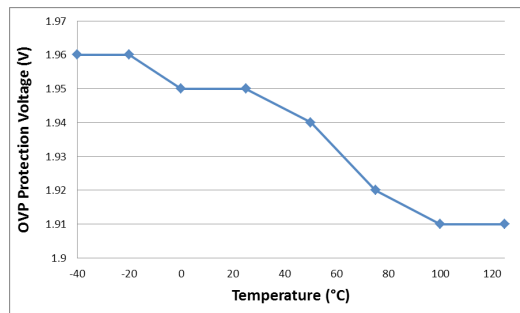

Fig.7 OVP Protection Voltage VS Temperature

Dimming Linearity

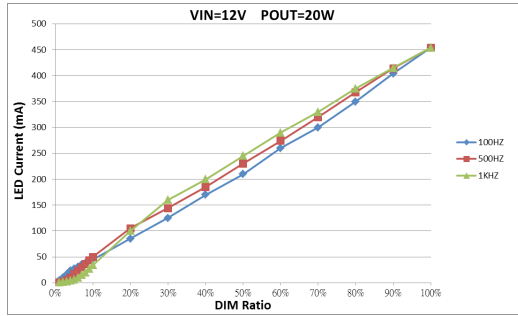

Fig.8 $V_{IN}=12V$, LED=16S5P, $V_{OUT}=44.5V$, $I_{OUT}=453mA$, $C_{OUT}=47\mu F$, $P_{OUT}=20W$ ($T_a=25^\circ C$)

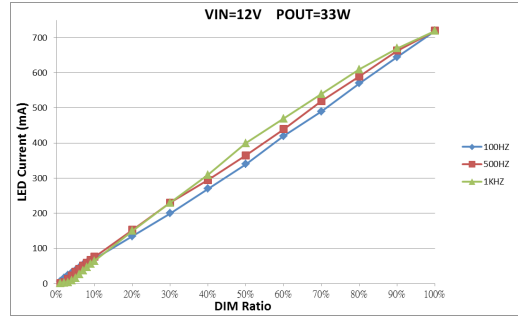

Fig.9 $V_{IN}=12V$, LED=16S5P, $V_{OUT}=45.8V$, $I_{OUT}=719mA$, $C_{OUT}=47\mu F$, $P_{OUT}=33W$ ($T_a=25^\circ C$)

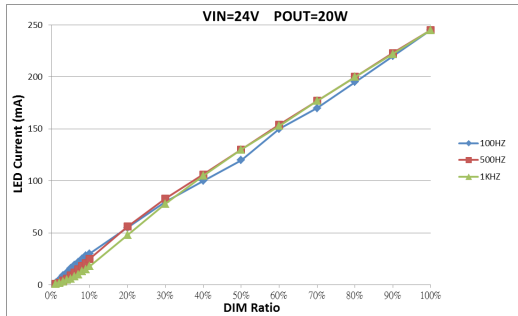

Fig.10 $V_{IN}=24V$, LED=30S5P, $V_{OUT}=81.5V$, $I_{OUT}=245mA$, $C_{OUT}=47\mu F$, $P_{OUT}=20W$ ($T_a=25^\circ C$)

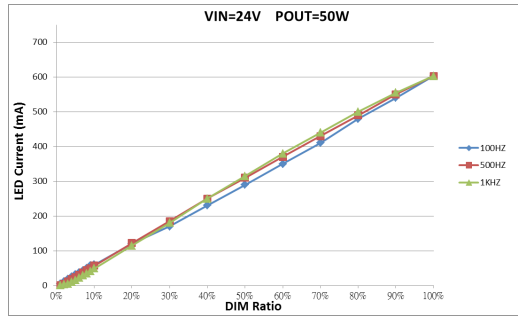

Fig.11 $V_{IN}=24V$, LED=30S5P, $V_{OUT}=84.3V$, $I_{OUT}=602mA$, $C_{OUT}=47\mu F$, $P_{OUT}=50W$ ($T_a=25^\circ C$)

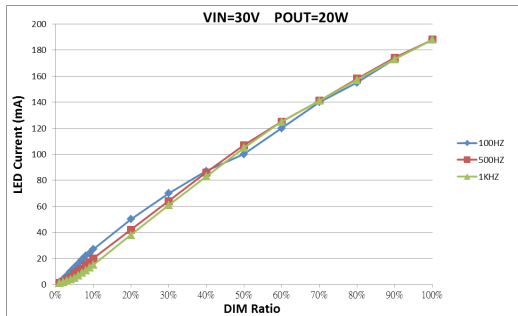

Fig.12 $V_{IN}=30V$, LED=40S5P, $V_{OUT}=106.8V$, $I_{OUT}=188mA$, $C_{OUT}=47\mu F$, $P_{OUT}=20W$ ($T_a=25^\circ C$)

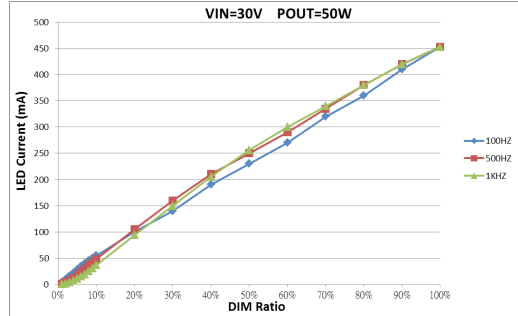

Fig.13 $V_{IN}=30V$, LED=40S5P, $V_{OUT}=110.5V$, $I_{OUT}=451mA$, $C_{OUT}=47\mu F$, $P_{OUT}=50W$ ($T_a=25^\circ C$)

Package Information

Note that the package information provided here is for consultation purposes only. As this information may be updated at regular intervals users are reminded to consult the [Holtek website](#) for the latest version of the [Package/ Carton Information](#).

Additional supplementary information with regard to packaging is listed below. Click on the relevant section to be transferred to the relevant website page.

- Further Package Information (include Outline Dimensions, Product Tape and Reel Specifications)
- Packing Materials Information
- Carton information

8-pin SOP (150mil) Outline Dimensions

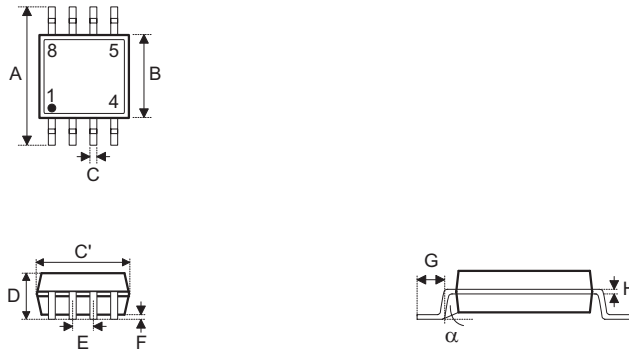

Symbol	Dimensions in inch		
	Min.	Nom.	Max.
A	—	0.236 BSC	—
B	—	0.154 BSC	—
C	0.012	—	0.020
C'	—	0.193 BSC	—
D	—	—	0.069
E	—	0.050 BSC	—
F	0.004	—	0.010
G	0.016	—	0.050
H	0.004	—	0.010
α	0°	—	8°

Symbol	Dimensions in mm		
	Min.	Nom.	Max.
A	—	6.00 BSC	—
B	—	3.90 BSC	—
C	0.31	—	0.51
C'	—	4.90 BSC	—
D	—	—	1.75
E	—	1.27 BSC	—
F	0.10	—	0.25
G	0.40	—	1.27
H	0.10	—	0.25
α	0°	—	8°

Copyright© 2015 by HOLTEK SEMICONDUCTOR INC.

The information appearing in this Data Sheet is believed to be accurate at the time of publication. However, Holtek assumes no responsibility arising from the use of the specifications described. The applications mentioned herein are used solely for the purpose of illustration and Holtek makes no warranty or representation that such applications will be suitable without further modification, nor recommends the use of its products for application that may present a risk to human life due to malfunction or otherwise. Holtek's products are not authorized for use as critical components in life support devices or systems. Holtek reserves the right to alter its products without prior notification. For the most up-to-date information, please visit our web site at <http://www.holtek.com.tw>.

X-ON Electronics

Largest Supplier of Electrical and Electronic Components

Click to view similar products for [LED Display Drivers](#) category:

Click to view products by [Holtek](#) manufacturer:

Other Similar products are found below :

[STP16CPP05XTTR](#) [SCT2027CSSG](#) [KP22306WGA](#) [KP1199AWPA](#) [KP1199BWPA](#) [WS9088AS7P](#) [GN1628T](#) [BCT3236EGH-TR](#)
[HT1628BRWZ](#) [KP1192SPA](#) [KP1182SPA](#) [KP1262FSPA](#) [KP1072LSPA](#) [KP1191SPA](#) [KP18001WPA](#) [KP1070LSPA](#) [KP1221SPA](#)
[KP107ALSPA](#) [GN1640T](#) [MBI5253GP-A](#) [MBI5124GM-B](#) [WS90561T S7P](#) [WS9821B S7P](#) [WS9032GS7P](#) [LYT3315D](#) [M08888G-11](#)
[M08890G-13](#) [BCR420U](#) [SCT2001ASIG](#) [SCT2024CSOG](#) [SCT2024CSSG](#) [SCT2024CSTG](#) [SCT2167CSSG](#) [AL8400QSE-7](#) [PR4401](#) [PR4403](#)
[PCA9685PW](#) [STP16CPC05XTTR](#) [WS2821B](#) [PR4402](#) [M08898G-13](#) [RT8471GJ5](#) [RT9284A-20GJ6E](#) [TLC59482DBQR](#) [ISL97634IRT14Z-](#)
[TK](#) [AW36413CSR](#) [LP5562TMX](#) [DLD101Q-7](#) [WS2818B](#) [BCR401U](#)