

MICRO SWITCH™ SX Series

Premium Subminiature Switch



DESCRIPTION

The industry-defining name in snap-action switches, Honeywell MICRO SWITCH™ premium subminiature switches are designed for repeatability and enhanced product life. MICRO SWITCH™ SX Series delivers repeatability and consistent performance within a range of conditions.

Offering enhanced repeatability, MICRO SWITCH™ SX Series' lower operating force provides for enhanced operation and application versatility. Its covered case construction with molded-in terminals allows for very simple adaptation to the customers' actuation systems.

FEATURES AND BENEFITS

- Best suited for high cost-of-failure applications
- Small size and light weight
- Extended operating life
- Elongated mounting holes provides for easier, more accurate mounting
- Choice of actuation, electrical termination, and operating characteristics
- High temperature construction options
- MIL-PRF-8805 qualified listings available
- UL/CSA, cUL, ENEC, and CE approvals

APPLICATIONS

- Aerospace
- Industrial
 - Appliances
 - Instrumentation
 - Office equipment
 - Valves
- Medical
 - Medical/dental equipment

MICRO SWITCH™ SX Series

Table 1. Specifications

Parameter	Characteristic
Differentiator	low operating force to 3 oz. max; sensitive differential travel as low as 0.001 in max.; power load switching capability to 7 A
Ampere rating	1 A to 7 A
Circuitry	SPDT, SPNO
Operating force	0.71 oz to 6 oz
Termination	quick connect, solder, pcb
Actuator	pin plunger, straight, roller, simulated roller, offset flag, crossed roller
Voltage	125 Vac, 250 Vac, 28 Vdc
Agency approvals	UL, CE, CSA, ENEC
Agency file information	UL: E12252; CSA: LR41372
Operating temperature	-55 °C to 125 °C [-67 °F to 267 °F]
Contacts	silver, gold
Housing	phenolic or valox
Sealing	MIL-PRF-8805 qualified listings available
Expected mechanical life	up to 10,000,000 operations for 11SX listings up to 1,000,000 operations for 1SX listings
Size	10,2 mm H x 5,08 mm W x 12,7 mm L [0.4 in H x 0.20 in W x 0.5 in L]

MICRO SWITCH™ SX SERIES AVAILABLE TERMINALS

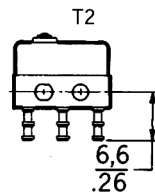
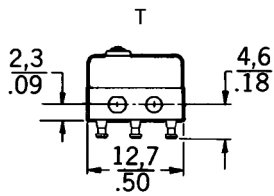

Mounting torque Round head 2-56 UNC 438 screws—
2 inch pounds max.

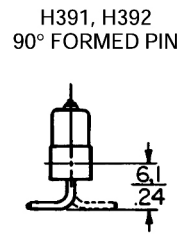
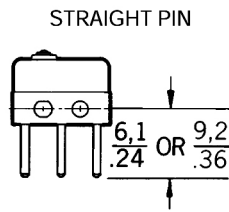
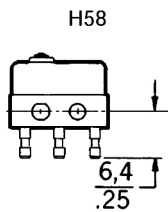

Mate with Amp Inc. Part No. 640024-1 Std.

Premium Subminiature Switch

MICRO SWITCH™ SX SERIES STANDARD LEVER OPTIONS AND DIMENSIONS mm/in

PIN PLUNGER

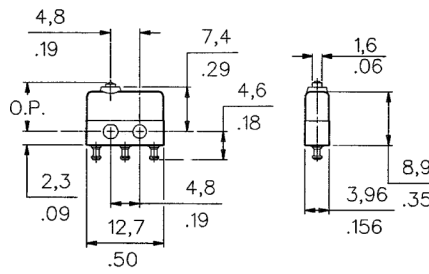
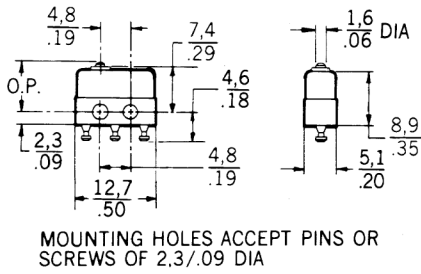

INTEGRAL LEVERS

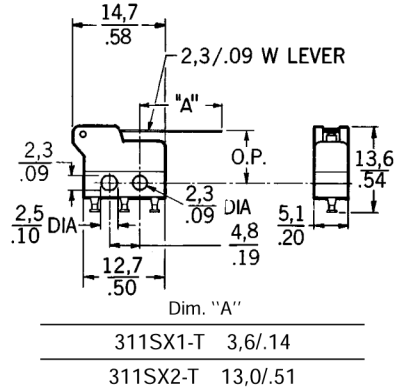

INTEGRAL LEVERS

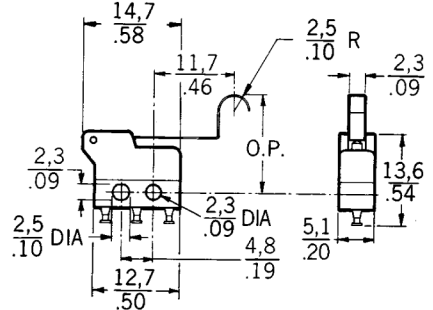
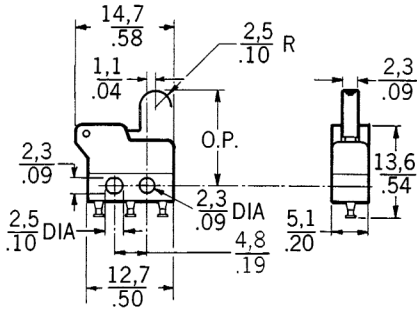
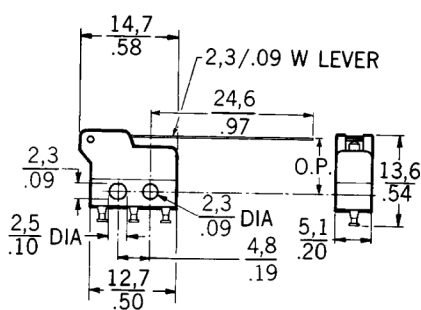

Interchangeable with 1SX-1T switch with JX-25 actuator.

AUXILIARY ACTUATORS

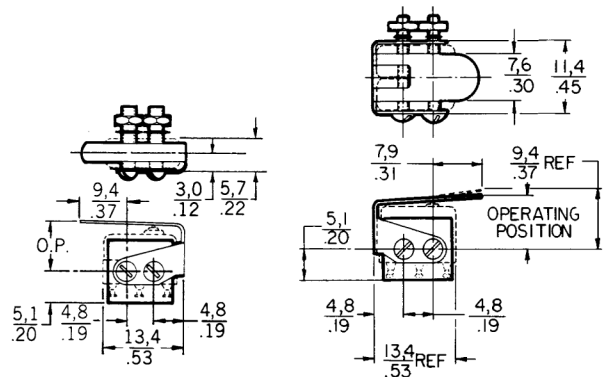
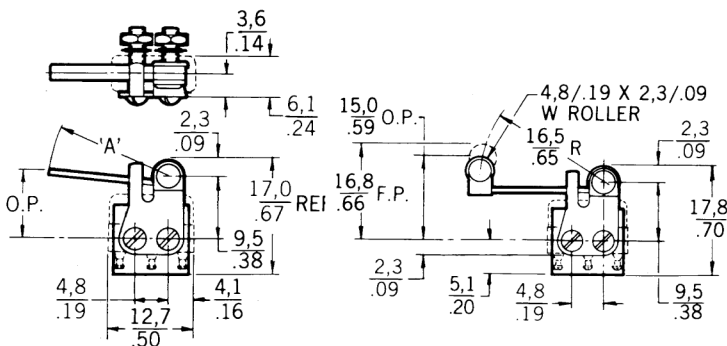

Switches are not included with actuator.

Mounting holes accept pins or screws of .087 diameter (2,21 mm).

Key: 0,0 = mm
0.00 = inches







MICRO SWITCH™ SX Series

NUMERIC DESIGNATIONS FOR MICRO SWITCH™ SX SERIES

Prefix	Description
1SX	Plastic pin plunger, fine silver contacts with 0.188 mounting hole centers
2SX	1SX except, low force characteristics (3 oz. max. operating force)
3SX	1SX except, gold/gold alloy contacts
4SX	1SX except, high temperature construction [400 °F]
5SX	"For factory use only" XE basics
6SX	1SX except, high temperature and gold/gold alloy contacts
7SX	2SX except, gold/gold alloy contacts
8SX	Case, switch assembly for "Newhouse only"
11SX	Low force characteristics (OF and DT)
12SX	11SX except, bifurcated gold contacts
13SX	11SX except, gold/gold alloy contacts
14SX	11SX except, high temperature construction
15SX	Reserved
16SX	Reserved
17SX	11SX except, diallyl phthalate material (obsolete)
18SX	11SX except, bifurcated contacts and diallyl phthalate material (obsolete)
19SX	11SX except, gold contacts and diallyl phthalate material (obsolete)
21SX	1SX except, MIL-approved
22SX	2SX except, MIL-approved
23SX	1SX except, gold/gold alloy contacts and MIL-approved
31SX	Reserved
33SX	Reserved
311SX	11SX except with integral lever actuator
312SX	12SX except with integral lever actuator
323SX	311SX except, gold/gold alloy contacts
91SX	Thin SX (0.156 in thick)
93SX	Thin SX (0.156 in thick), gold/gold alloy contacts
411SX	High temperature construction [400 °F]

Premium Subminiature Switch

MICRO SWITCH™ JX SERIES AUXILIARY ACTUATORS FOR THE MICRO SWITCH™ SX SERIES SWITCHES

		Description	Actuator length mm [in]	OF max. N [oz]	RF min. N [oz]	PT max. mm [in]	OT min. mm [in]	DT max. mm [in]	OP mm [in]****	FP max. mm [in]
JX-20		Straight lever (JX-219 for higher temperatures)	18,3 [0.72]	0,28 [1] approx.	0,04 [0.14]	–	0,76 [0.030] approx.	0,76 [0.030] approx.	10,8 [0.425] approx.	12,3 [0.485] approx.
JX-25		Roller lever (JX-220 for higher temperatures)	16,5 [0.65]	0,42 [1.5]	0,04 [1.4]	–	0,51 [0.020]	0,75 [0.030]	14,9 = 1,14 [0.585 = 0.045]	168 [0.660] max.
JX-40		Straight leaf (JX-95 for higher temperatures)	9,4 [0.37]*	1,95 [7]	0,56 [2]	[0.225] approx.	0,38 [0.015]	0,64 [0.025]	7,5 [0.295]	12,3 [0.485] ref.
JX-41**		Reverse leaf	9,4 [0.37]*	1,67 [6]	0,28 [1]	[0.110] approx.	0,38 [0.015]	0,64 [0.025]	7,5 [0.295]	9,4 [0.370] ref.
JX-45		Roller leaf (JX-96 for higher temperatures)	6,1 [0.24]*	1,95 [7]	0,28 [1]	[0.225] approx.	0,38 [0.015]	0,64 [0.025]	12,2 [0.480]	16,5 [0.650] ref.
JX-51**		Reverse roller leaf	7,6 [0.30]*	1,67 [6]	0,56 [2]	[0.110] approx.	0,38 [0.015]	0,64 [0.025]	12,8 [0.505]	14,7 [0.580] ref
JX-4		Tandem leaf	7,9 [0.31]	4,17 [15]	0,83 [3]	[0.065] approx.	0,20 [0.008]	0,76 [0.030]	7,6 [0.300]	9,40 [0.370] ref.

*** Switch is mounted with plunger end reversed from JX-40

**** Except where stated $\pm 0,76$ mm [± 0.030 in]

NOTE: Above actuators should be used

below 149 °C [300 °F], except listings JX-95, JX-96, JX-219, and JX-220 are for use with 4SX1-T to 204 °C [400 °F]

* "A" measurement is from center of mounting hole nearest tip of lever to the point indicated on the drawing.

MICRO SWITCH™ SX Series

This datasheet supports the following MICRO SWITCH™ SM Series Premium Subminiatures Switches.

11SX100-H58	13SX50-H58	21SX39-T2	313SX21-T	91SX39-T2
11SX1-H58	13SX51-H58	21SX64	313SX22-T	91SX43
11SX1-T	13SX52-H58	21SX81-H58	313SX2-T	91SX48
11SX21-H58	13SX95-T	21SX83-H340	313SX30-H33	91SX49
11SX21-T	13SX96-T	21SX88	313SX30-T	91SX51
11SX22-T	14SX101-T	23SX26	313SX3-T	93SX39-T
11SX24	14SX15-T	23SX39-H58	313SX4-H33	93SX39-T2
11SX27	14SX7-T	23SX39-T	313SX4-T	93SX47
11SX37-T	17SX21-T	23SX39-T2	313SX5-T	
11SX38-T	1SX100-H58	23SX59-T	35SX100	
11SX47-H58	1SX101-T	23SX64	3SX1-H58	
11SX48-H58	1SX106	23SX75-T2-C	3SX1-H58-C	
11SX50-H58	1SX12-T	23SX78-T2	3SX1-T	
11SX51-H58	1SX18-T	23SX83-H340	3SX1-T2-C	
11SX55-H58	1SX19-T	2SX1-H58	3SX82-T	
11SX81-T	1SX1-H58-C	2SX1-T	3SX97	
11SX95-T	1SX1-T	2SX1-T2	411SX21-T	
11SX96-T	1SX1-T2	2SX1-T2-C	411SX25-T	
11SX98-T	1SX1-T-C	2SX27-T	412SX21-T	
12SX12-T	1SX24	2SX4-T	412SX22-T	
12SX14-T	1SX26	2SX5-H58	413SX21-T	
12SX15-T	1SX26-C	2SX83	4PBSX-500	
12SX1-T	1SX31-T	2SX84-HF	4PBSX-501	
12SX22	1SX36-T	311SX146-H391	4PBSX-600	
12SX26	1SX38-T	311SX147-T2	4PBSX-601	
12SX2-T	1SX44-T	311SX1-T	4SX105-T	
12SX2-T2	1SX48-H58	311SX2-H33	4SX17-T	
12SX31-T	1SX48-T	311SX2-H58	4SX19-T	
12SX31-T-HYDRA	1SX74-T	311SX2-T	4SX1-H58	
12SX3-H58	1SX75-T2-C	311SX2-T2	4SX1-T	
12SX3-T	1SX81	311SX3-T	4SX1-T2	
12SX4-T	1SX86-T	311SX4-H33	4SX25	
12SX6	1SX88-T	311SX4-H391	4SX37-H58	
12SX86	1SX89-T2	311SX4-H58	4SX38-H58	
12SX89-T	1SX90-T	311SX4-T	4SX38-T	
12SX91-T	1SX92	311SX54-H58	4SX3-T	
12SX9-T	1SX95-T	311SX5-H58	4SX5-T	
13SX1-T	1SX98	311SX5-T	4SX7-T	
13SX21-H58	21SX14-T	311SX64-H58	4SX87-T	
13SX21-T	21SX1-T	311SX66-H392	4SX9-T	
13SX47-H58	21SX39-H58	312SX23-T	6SX7-T	
13SX48-H58	21SX39-T	313SX1-T	91SX39-T	

MICRO SWITCH™ SX Series

Premium Subminiature Switch

Warranty. Honeywell warrants goods of its manufacture as being free of defective materials and faulty workmanship. Honeywell's standard product warranty applies unless agreed to otherwise by Honeywell in writing; please refer to your order acknowledgement or consult your local sales office for specific warranty details. If warranted goods are returned to Honeywell during the period of coverage, Honeywell will repair or replace, at its option, without charge those items it finds defective. **The foregoing is buyer's sole remedy and is in lieu of all warranties, expressed or implied, including those of merchantability and fitness for a particular purpose. In no event shall Honeywell be liable for consequential, special, or indirect damages.**

While we provide application assistance personally, through our literature and the Honeywell web site, it is up to the customer to determine the suitability of the product in the application.

Specifications may change without notice. The information we supply is believed to be accurate and reliable as of this printing. However, we assume no responsibility for its use.

WARNING

PERSONAL INJURY

- DO NOT USE these products as safety or emergency stop devices or in any other application where failure of the product could result in personal injury.

Failure to comply with these instructions could result in death or serious injury.

WARNING

MISUSE OF DOCUMENTATION

- The information presented in this datasheet is for reference only. DO NOT USE this document as product installation information.
- Complete installation, operation and maintenance information is provided in the instructions supplied with each product.

Failure to comply with these instructions could result in death or serious injury.

Find out more

Honeywell serves its customers through a worldwide network of sales offices, representatives and distributors. For application assistance, current specifications, pricing or name of the nearest Authorized Distributor, contact your local sales office. To learn more about Honeywell's sensing and control products, call **+1-815-235-6847/1-800-537-6945**, visit **www.honeywell.com/sensing**, or e-mail inquiries to **info.sc@honeywell.com**

Sensing and Control
Honeywell
1985 Douglas Drive North
Golden Valley, MN 55422
www.honeywell.com

Honeywell

X-ON Electronics

Largest Supplier of Electrical and Electronic Components

Click to view similar products for [Toggle Switches](#) category:

Click to view products by [Honeywell](#) manufacturer:

Other Similar products are found below :

[8928K478](#) [020017-13](#) [60012L](#) [6006L](#) [CS115W](#) [CS120W](#) [637H/25](#) [6663](#) [7101SPDV30BE](#) [7103SDV30BE](#) [7105D](#) [7108P3YAV2BE](#)
[71YY50282](#) [7300K36](#) [7301K38](#) [7306K36](#) [7310K36](#) [7506K4](#) [7592K6](#) [7660K12](#) [7691K14](#) [7700K1](#) [8391K108](#) [8396K108](#) [8824K14](#)
[8828K13](#) [8835K3](#) [8858K44](#) [PS83-121G](#) [1-1825192-0](#) [A201SCWZB04](#) [A207SYCB04](#) [A208J61ZQ0004](#) [A221T1TCQ](#) [A232M1YCQ](#)
[A323S1CWZQ](#) [A423S1CWZG-M8](#) [1201W](#) [12156AX408](#) [12147AGKX679](#) [12246X778](#) [12TW49-3D](#) [130312](#) [13037L](#) [13001X](#)
[AE101MD1W4B04](#) [AE208SD1W4B04](#) [MS24659-22D](#) [MS27407-5](#) [1520230-9](#)