

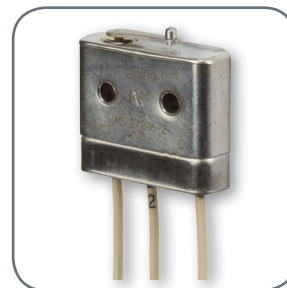

MICRO SWITCH™
Hermetic Sealed Basic Switches
HM Series



MICRO SWITCH™ HM Series

Hermetic Sealed Basic Switches

Honeywell HM hermetic sealed miniature basic switches are designed for a variety of commercial and military aircraft as well as equipment for deep space applications (high altitude requirements). These miniature hermetic sealed switches can be found in a variety of other applications including military land vehicles, marine environments, and other harsh industrial environments. The switches are available as a MIL-PRF-8805 qualified switch. Select HM switches are available with UL 508 certification for industrial or surface transportation applications. The MICRO SWITCH™ HM hermetic sealed switch design incorporates the glass-to-metal and metal-to-metal sealing with more than 50 years of use in multiple applications.

The hermetically sealed HM basic switches are ideal where a symbol 5 seal is required for stringent applications including a wide range of temperatures from -184 °C to 260 °C [-300 °F to 500 °F]. Designed with a stainless steel housing and hermetic seal construction, the HM switches are suitable for applications where dust, water, other particulate contaminants, and corrosive gases are present.

The HM basic switch provides versatility with bifurcated gold contacts for controlling low energy loads (mA and mV) reliably or silver contacts for switching power duty loads at 30 vdc or 115 Vac, 400 Hz. Electrical connectivity to the switch is achieved with individual wire leads or “through hole” solder posts adding to the versatility of the HM switch.

What makes our switches better?

- Precisely detects position of mechanical components within a particular system that is susceptible to physical and atmospheric (corrosive gas, oxygen, etc.) elements
- Consistent and precise performance in a hermetic-sealed package for adverse, inclement environments
- Functionality over a large temperature range – can tolerate very low and high temperatures
- Honeywell can create value-added HM assemblies for unique, custom applications beyond a simple HM switch
- HM switches are available with MIL-PRF-8805 qualifications or UL 508 certifications



HM Series: when you need a switch with out-of-this-world performance!

HIGH PERFORMANCE • DURABILITY
CONFIGURABLE • COMPACT

Features and Benefits

MIL-QUALIFIED

MICRO SWITCH™ HM switches are **hermetically sealed** with versions that are **MIL-PRF-8805** qualified for demanding military or commercial applications on aircraft, spacecraft, or ground vehicles.

UL CERTIFIED

Select HM catalog listings are **UL 508 certified** for industrial and surface transportation applications.

TINY

Miniature package size requires minimal space on equipment.

Hermetically sealed with wide temperature range

SEALED TIGHT

HM Series' **Symbol 5** hermetic-sealed enclosures are suitable for applications at sea level, high altitude, or deep space.

LOW VOLTAGE AND POWER DUTY CAPABILITY

MICRO SWITCH™ HM products are available with **silver contacts** for control of power duty circuits or **gold contact surfaces** for control of logic level circuits.

LEVERS FURTHER EXPAND FUNCTIONALITY

Auxiliary actuators expand the versatility of the switch for additional applications.

WELL SUITED FOR LOW AND HIGH TEMPERATURES

For endurance in harsh temperature environments, **wide temperature range** is available from -184 °C to 260 °C [-300 °F to 500 °F]. Operate point stability is maintained over the specified temperature range.

Potential Applications



MILITARY AIRCRAFT AND HELICOPTERS

- Detects landing gear bay doors in closed and locked position
- Senses engine fuel valve position
- Identifies when external hatches and doors are in closed and/or locked position

COMMERCIAL AIRCRAFT AND HELICOPTERS

- Detects landing gear bay doors in closed and locked position
- Senses engine fuel valve position
- Identifies when external hatches and doors are in closed and/or locked position
- Miscellaneous applications inside commercial aircraft cabin, including waste management valve position, refreshment (liquids and food) stowed and locked position, HVAC, and oxygen valve position



AVIATION GROUND SUPPORT EQUIPMENT

- Monitor position of valves, doors or panels, for open, closed, or locked position

SPACECRAFT

- Identifies when external hatches and doors are in closed and/or locked position
- Senses engine fuel valve position
- Select sensing applications inside spacecraft cabin



POWER GENERATION, OIL AND GAS

- Internal switch element in pressure switches, temperature switches, and/or flow switches

MICRO SWITCH™ Hermetic Sealed Basic Switches

Table 1. Specifications

Characteristic	
Description	hermetic sealed miniature snap-action switch
Housing material	300 series stainless steel
Mechanical endurance	25,000 operations min.
Electrical endurance	25,000 operations min.
Dielectric voltage (initial)	1000 Vrms for 1 minute
Circuitry	SPDT
Contact material	silver, gold, gold bifurcated
Electrical rating	up to 4 A at 28 Vdc (ref. electrical rating table)
Sealing	symbol 5, hermetic sealed to MIL-PRF-8805
Temperature range	-65 °C to 121 °C [-85 °F to 250 °F] (see catalog listing table)
Temperature range (optional)	-184 °C to 260 °C [-300 °F to 500 °F] (see catalog listing table)
Vibration	symbol 2 (15 g), 10 to 2000 Hz
Mechanical shock	shock type M (100 G, saw tooth)
Approvals (refer to page 7)	MIL-PRF-8805, UL 508 (File E66520)
Actuators (auxiliary)	straight leaf, roller leaf, straight lever, roller lever

Table 2. Electrical Ratings

Rating code	
A	sea level @ 28 Vdc; 3 A res. and 1 A ind. 70,000 feet @ 28 Vdc; 3 A res. and 1 A ind. sea level @ 115 Vac & 400 Hz; 1 A res. and 1 A ind.
B	sea level @ 28 Vdc; 1 A res. and 0.25 A ind. 70,000 feet @ 28 Vdc; 1 A res. and 0.25 A ind.
C	sea level @ 28 Vdc; 0.5 A res. and 0.25 A ind. 70,000 feet @ 28 Vdc; 0.5 A res. and 0.25 A ind.
D	sea level @ 28 Vdc; 4 A res., 2 A ind. and 1 A lamp 70,000 feet @ 28 Vdc; 4 A res., 2 A ind. and 1 A lamp sea level @ 115 Vac & 400 Hz; 2 A res., 2 A ind. and 0.5 A lamp
E	sea level @ 28 Vdc; 4 res. and 2 A ind. sea level @ 115 Vac and 400 Hz; 2.5 A res. and 2.5 A ind.

Table 3. UL 508 Electrical Ratings

Rating code	
F	28 Vdc, 0.5 A res.; -65 °C to 125 °C [-85 °F to 257 °F]
G	28 Vdc, 3 A res.; -65 °C to 125 °C [-85 °F to 257 °F]
H	28 Vdc, 0.5 A res.; -65 °C to 260 °C [-85 °F to 500 °F]
J	28 Vdc, 4 A res.; -65 °C to 260 °C [-85 °F to 500 °F]

ELECTROMECHANICAL SWITCHES

Definitions below explain the meaning of operating characteristics. Characteristics shown in tables were chosen as most significant. They are taken at normal room temperature and humidity. These may vary as temperature and humidity conditions differ. Sketches show how characteristics are measured for in-line plunger actuation.

Linear dimensions for in-line actuation are from top of plunger to a reference line, usually the center of the mounting holes.

Differential Travel (D.T.) – Plunger or actuator travel from point where contacts “snap-over” to point where they “snap-back.”

Free Position (F.P.) – Position of switch plunger or actuator when no external force is applied (other than gravity).

Full Overtravel Force – Force required to attain full overtravel of actuator.

Operating Position (O.P.) – Position of switch plunger or actuator at which point contacts snap from normal to operated position. Note that in the case of flexible or adjustable actuators, the operating position is measured from the end of the lever or its maximum length. Location of operating position measurement shown on mounting dimension drawings.

Operating Force (O.F.) – Amount of force applied to switch plunger or actuator to cause contact “snap-over.” Note in the case of adjustable actuators, the force is measured from the maximum length position of the lever.

Overtravel (O.T.) – Plunger or actuator travel safely available beyond operating position.

Pretravel (P.T.) – Distance or angle traveled in moving plunger or actuator from free position to operating position.

Release Force (R.F.) – Amount of force still applied to switch plunger or actuator at moment contacts snap from operated position to unoperated position.

Total Travel (T.T.) – Distance from actuator free position to overtravel limit position.

IN-LINE PLUNGER ACTUATION

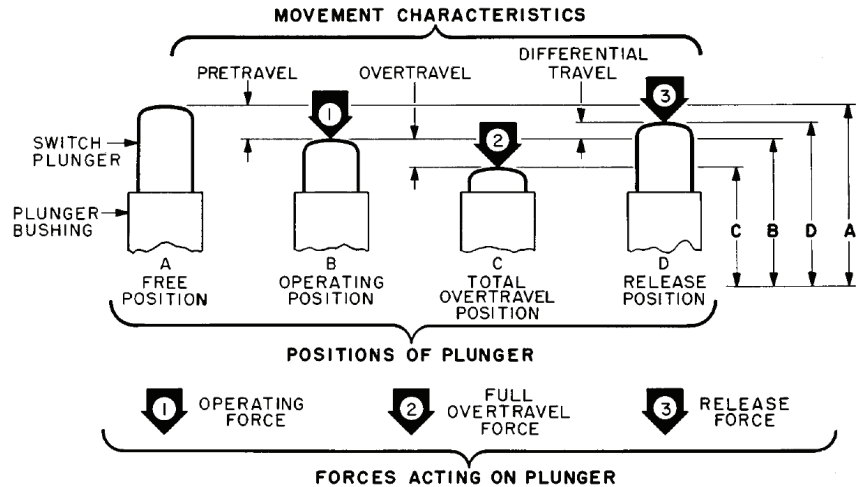





MICRO SWITCH™ Hermetic Sealed Basic Switches

O.F. • Operating force
 R.F. • Release force
 P.T. • Pretravel
 O.T. • Overtravel
 D.T. • Differential travel
 O.P. • Operating position

MICRO SWITCH™ HM SERIES PRODUCT SPECIFICATIONS AND LISTINGS

Contact your Honeywell rep or distributor for additional listings





	Catalog Listing	Elect. Rating Spec. (page 5)	Temperature range	Termination	O.F. max. g [oz]	R.F. max. g [oz]	P.T. max. mm [in]	O.T. min. mm [in]	D.T. max. mm [in]	O.P. mm [in]	Comment
	11HM1 [MS 27216-5]	A	-184 °C to 121 °C [-300 °F to 250 °F]	Thru-hole solder post	198 [7]	28 [1]	0,76 [0.03]	0,08 [0.003]	0,15 [0.006]	8,38 [0.33]	MIL-PRF 8805 applications
	11HM1 [UL 508]	G	-65 °C to 125 °C [-85 °F to 257 °F]	Thru-hole solder post	198 [7]	28 [1]	0,76 [0.03]	0,08 [0.003]	0,15 [0.006]	8,38 [0.33]	UL 508 applications
	13HM1	B	-184 °C to 121 °C [-300 °F to 250 °F]	Thru-hole solder post	198 [7]	28 [1]	0,76 [0.03]	0,08 [0.003]	0,15 [0.006]	8,38 [0.33]	Gold contacts
	9HM1 [MS27216-6]	C	-184 °C to 121 °C [-300 °F to 250 °F]	Thru-hole solder post	198 [7]	28 [1]	0,76 [0.03]	0,08 [0.003]	0,15 [0.006]	8,38 [0.33]	MIL-PRF 8805, bifurcated gold contacts
	9HM1 [UL 508]	F	-65 °C to 125 °C [-85 °F to 257 °F]	Thru-hole solder post	198 [7]	28 [1]	0,76 [0.03]	0,08 [0.003]	0,15 [0.006]	8,38 [0.33]	UL 508 applications, bifurcated gold contacts
	2HM19-1 [MS27216-2]	D	-65 °C to 125 °C [-85 °F to 257 °F]	Wire leads (3) 305 mm [12 in]	198 [7]	28 [1]	0,76 [0.03]	0,08 [0.003]	0,15 [0.006]	8,38 [0.33]	MIL-PRF 8805 applications
	2HM19-5 [MS27216-4]	D	-65 °C to 125 °C [-85 °F to 257 °F]	Wire leads (3) 1524 mm [60 in]	198 [7]	28 [1]	0,76 [0.03]	0,08 [0.003]	0,15 [0.006]	8,38 [0.33]	MIL-PRF 8805 applications
	16HM1-1	A	-65 °C to 260 °C [-85 °F to 500 °F] (-184 °C [-300 °F] if wires non-flexing)	Wire leads (3) 305 mm [12 in]	198 [7]	28 [1]	0,76 [0.03]	0,08 [0.003]	0,15 [0.006]	8,38 [0.33]	Up to 260 °C [500 °F]
	15HM2	A	-65 °C to 260 °C [-85 °F to 500 °F]	Thru-hole post	198 [7]	28 [1]	0,76 [0.03]	0,08 [0.003]	0,15 [0.006]	8,38 [0.33]	Up to 260 °C [500 °F]
	15HM5	A	-184 °C to 260 °C [-300 °F to 500 °F]	Thru-hole solder post	198 [7]	28 [1]	0,76 [0.03]	0,08 [0.003]	0,10 [0.004]	8,38 [0.33]	Up to 260 °C [500 °F]
	5HM1	E	-184 °C to 260 °C [-300 °F to 500 °F]	Thru-hole solder post	198 [7]	28 [1]	0,76 [0.03]	0,08 [0.003]	0,15 [0.006]	8,38 [0.33]	Up to 260 °C [500 °F]
	5HM1 [UL 508]	J	-65 °C to 260 °C [-85 °F to 500 °F]	Thru-hole solder post	198 [7]	28 [1]	0,76 [0.03]	0,08 [0.003]	0,15 [0.006]	8,38 [0.33]	UL 508 applications
	19HM1	C	-184 °C to 260 °C [-300 °F to 500 °F]	Thru-hole solder post	198 [7]	28 [1]	0,76 [0.03]	0,08 [0.003]	0,15 [0.006]	8,38 [0.33]	Up to 260 °C [500 °F]
	19HM1 [UL 508]	H	-65 °C to 260 °C [-85 °F to 500 °F]	Thru-hole solder post	198 [7]	28 [1]	0,76 [0.03]	0,08 [0.003]	0,15 [0.006]	8,38 [0.33]	UL 508 applications
	19PA137-HM*	-	-	-	-	-	-	-	-	-	Force spreading plate

* Recommended to minimize force on housing of HM switch and any resulting damage to switch housing.

Note: Torque on #2 mounting screws must not exceed 0,17 Nm [1.5 in-lb]. The force spreading plate, 19PA137-HM, will allow up to 0,28 Nm [2.5 in-lb] of mounting torque.

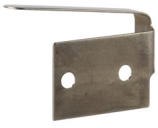
HM Series

JS SERIES LEVERS SPECIFICATIONS* (WHEN ASSEMBLED TO 6HM1-1)

		Description	Actuator Length mm [in]	Operating Force max. g [oz]	Release Force min. g [oz]	Pretravel nom. mm [in]	Overtravel min. mm [in]	Differential Travel max. mm [in]	Operating Point nom. mm [in]	Free Position nom. mm [in]
JS-254		Straight leaf	8,13 [0.32]	255 [9]	57 [2]	3,56 [0.14]	0,76 [0.03]	0,76 [0.03]	8,64 [0.34]	12,2 [0.48]
JS-151		Roller leaf <i>(mounting hardware included)</i>	8,13 [0.32]	255 [9]	57 [2]	3,56 [0.14]	0,76 [0.03]	0,76 [0.03]	14 [0.55]	17,5 [0.69]
JS-307		Straight lever <i>(mounting hardware included)</i>	26,16 [1.03]	43 [1.5]	3 [0.11]	3,18 [0.125]	0,64 [0.025]	1,42 [0.056]	10,3 [0.406]	13,49 [0.531]
JS-308		Roller lever <i>(mounting hardware included)</i>	25,4 [1.00] radius	43 [1.5]	3 [0.11]	3,18 [0.125]	0,64 [0.025]	1,42 [0.056]	14,3 [0.562]	17,45 [0.687]

* Stainless steel actuators, including roller and mounting hardware (when provided).

MICRO SWITCH™ Hermetic Sealed Basic Switches

PRODUCT AND ACTUATOR DIMENSIONS

Figure 1. MICRO SWITCH™ HM, Solder Terminal

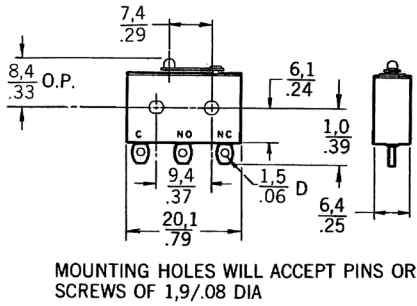

Figure 2. MICRO SWITCH™ HM, Wire Leads

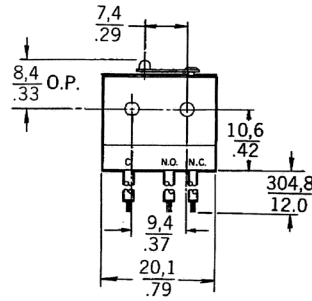

Figure 3. MICRO SWITCH™ HM, Wire Leads

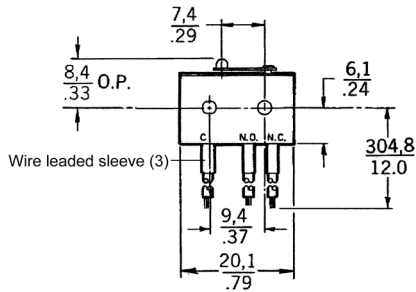

Figure 4. JS-254 Dimensions

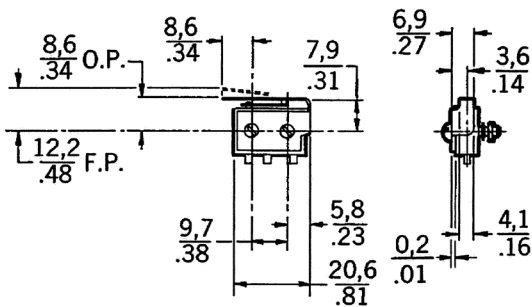

Figure 5. JS-151 Dimensions

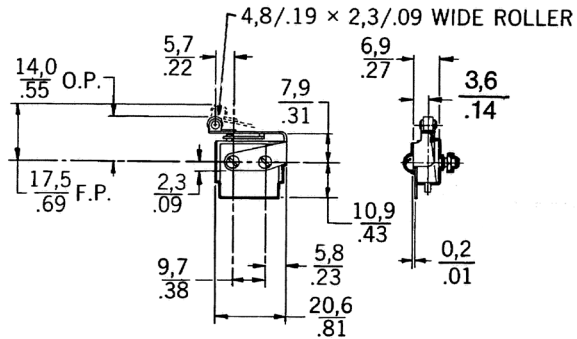

Figure 6. JS-307 Dimensions

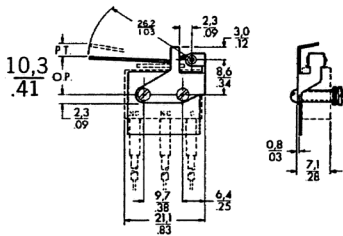
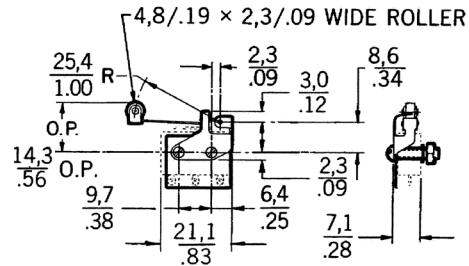

Figure 7. JS-308 Dimensions



Key: 0,0 = mm
0.00 = inches

ADDITIONAL INFORMATION

The following associated literature is available on the Honeywell web site at sensing.honeywell.com:

- Product installation instructions
- Product range guide
- Aerospace range guide

Find out more

Honeywell serves its customers through a worldwide network of sales offices, representatives and distributors. For application assistance, current specifications, pricing or name of the nearest Authorized Distributor, contact your local sales office.

To learn more about Honeywell's sensing and switching products, call **+1-815-235-6847** or **1-800-537-6945**, visit **sensing.honeywell.com**, or e-mail inquiries to **info.sc@honeywell.com**

Sensing and Productivity Solutions
Honeywell
1985 Douglas Drive North
Golden Valley, MN 55422
honeywell.com

WARNING

PERSONAL INJURY

DO NOT USE these products as safety or emergency stop devices or in any other application where failure of the product could result in personal injury.

Failure to comply with these instructions could result in death or serious injury.

WARNING

MISUSE OF DOCUMENTATION

- The information presented in this product sheet is for reference only. Do not use this document as a product installation guide.
- Complete installation, operation, and maintenance information is provided in the instructions supplied with each product.

Failure to comply with these instructions could result in death or serious injury.

WARRANTY/REMEDY

Honeywell warrants goods of its manufacture as being free of defective materials and faulty workmanship. Honeywell's standard product warranty applies unless agreed to otherwise by Honeywell in writing; please refer to your order acknowledgement or consult your local sales office for specific warranty details. If warranted goods are returned to Honeywell during the period of coverage, Honeywell will repair or replace, at its option, without charge those items it finds defective. **The foregoing is buyer's sole remedy and is in lieu of all other warranties, expressed or implied, including those of merchantability and fitness for a particular purpose. In no event shall Honeywell be liable for consequential, special, or indirect damages.**

While we provide application assistance personally, through our literature and the Honeywell website, it is up to the customer to determine the suitability of the product in the application.

Specifications may change without notice. The information we supply is believed to be accurate and reliable as of this printing. However, we assume no responsibility for its use.

Honeywell

X-ON Electronics

Largest Supplier of Electrical and Electronic Components

Click to view similar products for [Basic / Snap Action Switches](#) category:

Click to view products by [Honeywell](#) manufacturer:

Other Similar products are found below :

[83228001](#) [01.098.1358.1](#) [602EN1-6B](#) [602EN532](#) [602EN535-RB](#) [602HE5-RB1](#) [604HE162](#) [604HE223-6B](#) [624HE17-RB](#) [6HM89](#) [6PA78-JM](#)
[6SE1](#) [6SX1-H58](#) [70500840](#) [MBD5B1](#) [MBH2731](#) [73-316-0012](#) [79211759](#) [79211923](#) [79218589](#) [7AS12](#) [ML-1155](#) [ML-1376](#) [831010C3.0](#)
[831060C3.TL](#) [831090C2.EL](#) [83131904](#) [84212012](#) [8AS239](#) [8HM73-3](#) [903VB1-PG](#) [914CE1-6G](#) [PL-100](#) [11SM1077-H4](#) [11SM1077-H58](#)
[11SM1-TN107](#) [11SM405](#) [11SM703-T](#) [11SM8423-H2](#) [11SX37-T](#) [11SX48-H58](#) [11SX55-H58](#) [11SM2442-T](#) [11SM76-T](#) [11SM77-H58](#)
[11SM77-T](#) [11SM863-T](#) [11SM866](#) [11SX47-H58](#) [A7CN-1M-1-LEFT](#)