

Series 43 and  
**1 1/8 in. Diameter, 2 and 4 Watt**  
 Wirewound Potentiometers

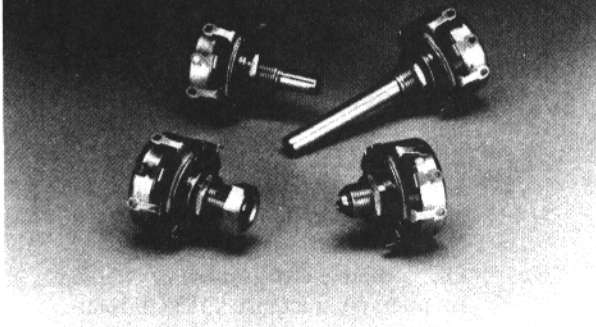

**Features**

- *Economical*
- *Versatile - various mounts, terminal & shaft configurations*
- *High torque available*
- *Shaft & mounting seals available*
- *Multiple gangs available*
- *Concentric shafts available*
- *Printed circuit terminals*
- *High voltage standoffs*
- *Non-metallic shaft*
- *Backlash construction (venier application)*

**Description**

**Series 43**

1 1/8 in. diameter, 2 watt, wirewound potentiometers

**Series 43M/RA20**

Military version of the 43 series meeting strict military standard MIL-R-19

**Series A43**

Pick-A-Shaft version of the 43 series.

~~**Series 45**~~

~~4 watt power rating version of the 43 series, all other specifications as standard.~~

**Series 43 Electrical Specifications**

**Series 45 Electrical Specifications**

<i>Resistance Range</i>	1Ω to 50KΩ linear; please consult Factory for non-linear.	1Ω to 10KΩ linear; please consult Factory for non-linear.
<i>Resistance Tolerance</i>	±10% standard; ±5% to ±1% special* (please consult Factory).	±10% standard; ±5% to ±1% special* (please consult Factory).
<i>Power Rating (Watts)</i>	Single section: 2 @ 40°C; 0 @ 105°C. Each additional section: 1.5 @ 40°C; 0 @ 105°C.	Single section: 4 @ 40°C; 0 @ 135°C. Each additional section: 3 @ 40°C; 0 @ 135°C.
<i>Watts/Degree</i>	.0071 watt per degree of effective rotation maximum	.014 watt per degree of effective rotation maximum
<i>Effective Rotation</i>	280° ±5° without switch; less than 280°, special; 260° ±5° with switch	280° ±5° without switch; less than 280°, special; 260° ±5° with switch
<i>Electrical Rotation</i>	300° ±5° with and without switch	300° ±5° with and without switch
<i>Tapers</i>	90Ω per degree maximum	36Ω per degree maximum
<i>Independent Linearity</i>	±5% standard; ±1% special*	±5% standard; ±1% special*

*Electrical specifications continued, next page*

<b>End Resistance</b>	1 to 50 $\Omega$ - 0.3 $\Omega$ ; 51 to 100 $\Omega$ - 0.5 $\Omega$ . Over 100 $\Omega$ - 0.2% of total or 1 $\Omega$ , whichever is greater.	1 to 50 $\Omega$ - 0.3 $\Omega$ ; 51 to 100 $\Omega$ - 0.5 $\Omega$ . Over 100 $\Omega$ - 0.2% of total or 1 $\Omega$ , whichever is greater.
<b>Dielectric Withstanding Voltage</b>	1000 Vac for 60 seconds @ ATM. 450 Vac for 60 seconds @ 3.4 in. Hg.	1000 Vac for 60 seconds @ ATM. 450 Vac for 60 seconds @ 3.4 in. Hg.
<b>Working Voltage</b>	310 volts maximum	350 volts maximum
<b>Switches</b>	S.P.S.T., S.P.D.T., D.P.S.T., See Figure 3, page 78 for switch characteristics.	S.P.S.T., S.P.D.T., D.P.S.T., See Figure 3, page 78 for switch characteristics.
<b>Location of Tap and Tolerance</b>	One available any position of effective rotation; tap tolerance $\pm 10\%$ of total resistance. Specify electrical or angular position and limits.	One available any position of effective rotation; tap tolerance $\pm 10\%$ of total resistance. Specify electrical or angular position and limits.
<b>Insulation Resistance</b>	100 Megohms minimum	100 Megohms minimum

**Series 43 Mechanical Specifications**

**Mechanical Rotation**  
300°  $\pm 5^\circ$  with and without switch; 360° special

**Stop Torque**  
8 lbs. in. maximum

**Torque Range**  
0.5 to 6 oz. in.; 15 oz. in. increase for switch actuation.  
Locking type bushing: 25 oz. in. minimum with jam nut tightened to 10 lb. in.

**Maximum Number of Sections**  
Two recommended, three available

**Weight**  
Single .077 lb. without switch.  
Additional section 0.041 lb.; .087 lb. with switch.

- Hardware**  
Must be ordered separately.
- (a) Hex mounting nut, 3/8 in. (9.53mm) x 32 thread 1/2 in. (12.7mm) across flats, 3/32 in. (2.38mm) thick.
  - (b) Internal tooth lockwasher 11/16 in. (17.46mm) O.D. x .022 in. (0.56mm) thick.
  - (c) Jam hex nut 1/2 in. (12.7mm) across flats, 7/32 in. (5.56mm) thick, supplied on locking type bushing.

**Marking**  
Will appear on rear surface without switch. On periphery when switch is used. Unless otherwise specified, marking will consist of

- (a) Customer part number or Clarostat part number,
- (b) EIA source and date code.

**Series 43 Operational Specifications**

Potentiometers per MIL-R-19 specifications, Style RA20 (43 series only)

**Resistance Range**  
3 $\Omega$  to 15K $\Omega$  A taper. For C and E tapers, please consult Factory.

**Operating Temperature Range**  
-55°C to 105°C

\*Dependent on design parameters.

NOTE: SPECIFICATIONS SUBJECT TO CHANGE WITHOUT NOTICE.

Figure 1  
**Resolution Graph**

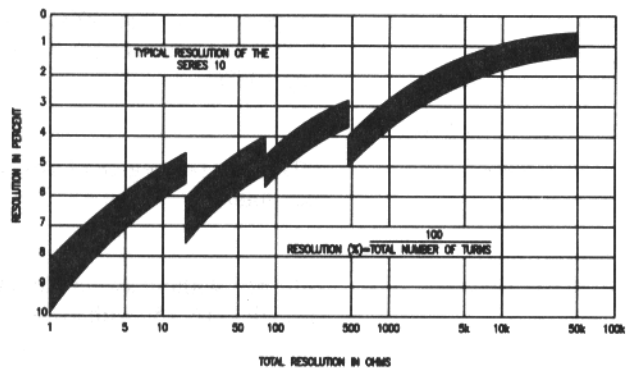

Figure 2  
Chart A

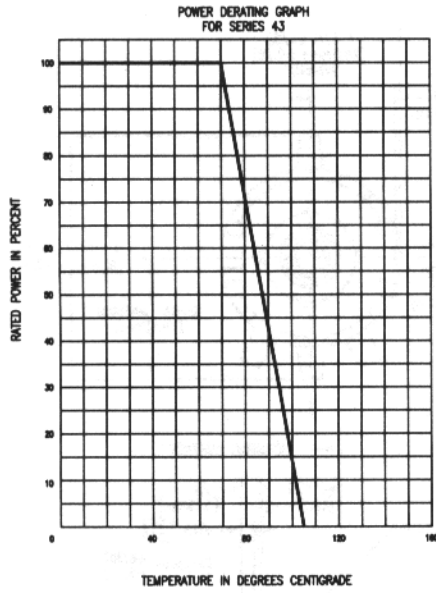
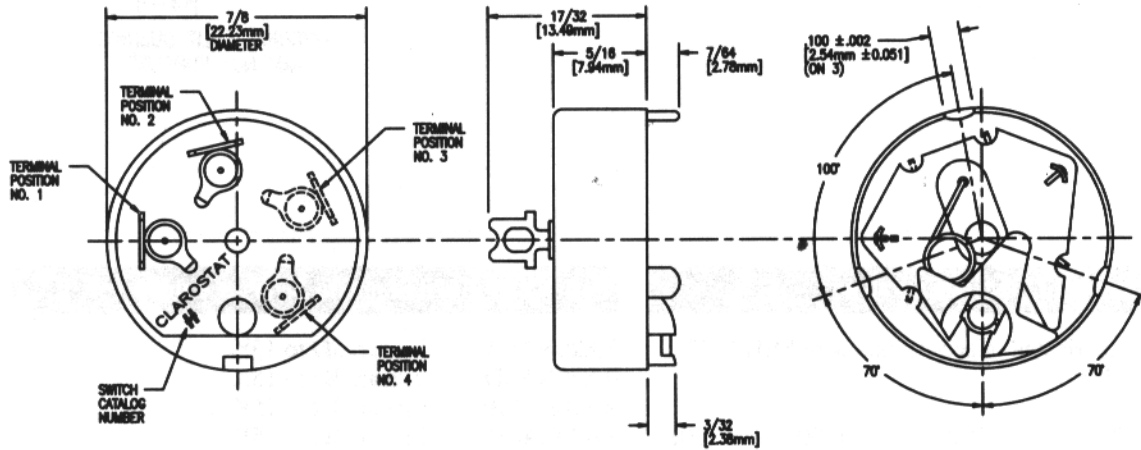

Figure 3  
AE Switch Dimensions



Type Number	Switch	Variations	Terminal Positions	Max. Operating Torque-Oz.In.
AE-10	S.P.S.T.	1a, 250V; 3a, 125V (ac or dc)	1-2	12
AE-11	S.P.S.T.	1a, 250V; 3a, 125V with bussing terminal (ac or dc)	1-2-4	12
AE-13	S.P.S.T.	15a, 10V (dc only)	1-4	16
*AE-20	D.P.S.T.	1a, 250V; 3a, 125V (ac or dc)	1-2-3-4	16
AE-21	D.P.	1 pole on, 1 pole off-1a, 250V; 3a, 125V (ac or dc)	1-2-3-4	16
AE-23	D.P.S.T.	15a, 10V (dc only)	1-2-3-4	16
*AE-24	D.P.S.T.	1a, 250V; 3a, 125V (ac or dc) Reverse action	1-2-3-4	16
AE-25	D.P.S.T.	250 ma. 24 Vdc (dry circuit)	1-2-3-4	12
AE-30	S.P.D.T.	1a, 250V; 3a, 125V (ac or dc)	2-3-4	16

\*May be employed as a single pole, single throw, two circuit switch.  
To designate this application add an "A" to the end of switch type.

Example: AE-20A.

Design details may change without notice; certified drawing available on request.

\*Unless Otherwise Specified

Figure 4

Series 43 Dimensions

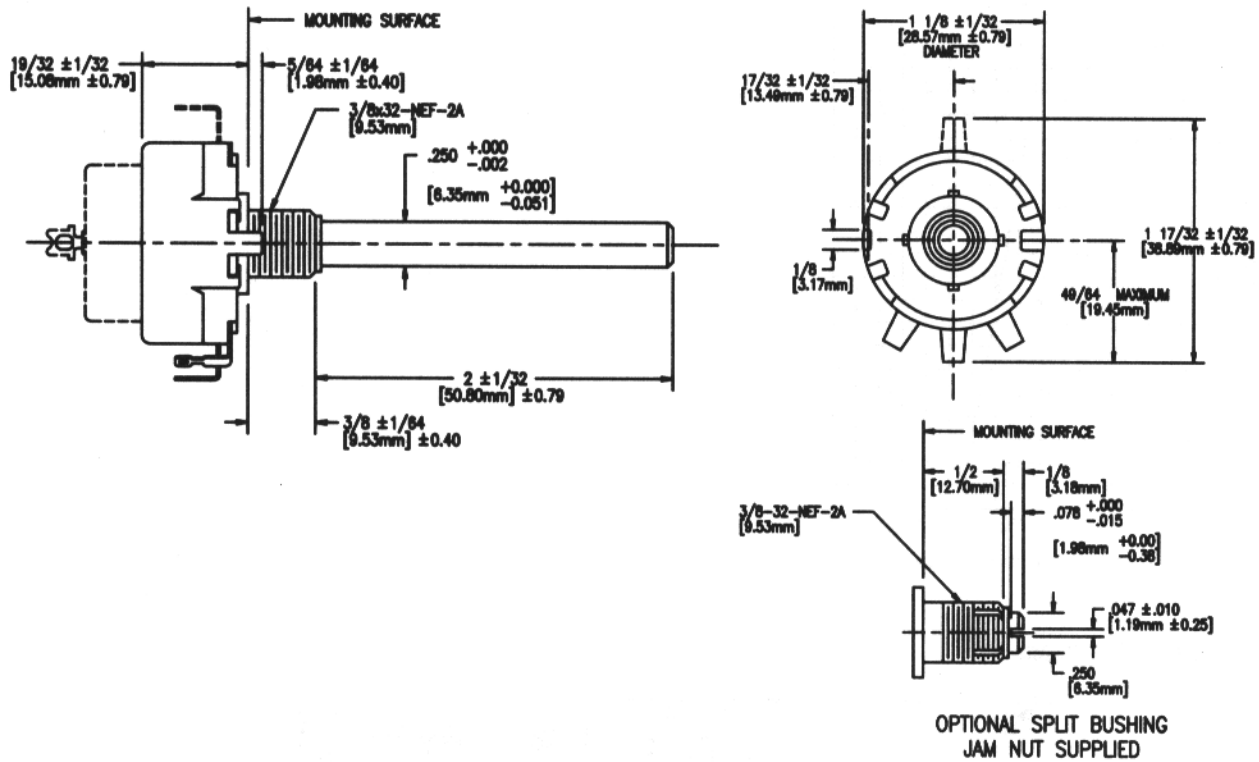

Series 43 Standard Resistance Values

Stock values fabricated in accordance with MIL-R-19 where applicable.

5	75	500	4000	30K
10	100	750	5000	40K
20	150	1000	7500	50K
25	200	1500	10K	
30	250	2000	15K	
40	300	2500	20K	
50	400	3000	25K	

Series 43 How To Order

Example: **43C1-5000**

**43C1**

Series Catalog Number

43C1 = 2 in. (50.8mm) round shaft FMS;  
3/8 in. (9.53mm) long bushing  
with 3/8-32-NEF-2A thread.

43C2 = 5/8 in. (15.88mm) screwdriver slotted shaft FMS;  
with a 1/2 in. (12.7mm) split locking bushing  
with 3/8 in. (9.53mm)-32-NEF-2A thread.

**5000**

Resistance Value  
(Ohms)

Series 43M/RA20 Standard Styles & Values

- RA20NASA: Linear, 3Ω to 15K
- RA20NASD: Linear, 3Ω to 15K
- RA20LASB: Linear, 3Ω to 15K
- RA20LASD: Linear, 3Ω to 15K

Ordering Codes

30A	151A	351A
60A	152A	352A
80A	153A	500A
100A	200A	501A
101A	201A	502A
102A	202A	750A
103A	250A	751A
150A	350A	752A

## Series 43M/RA20 How To Order

Example: **RA20-N-A-S-D-10-3-A**

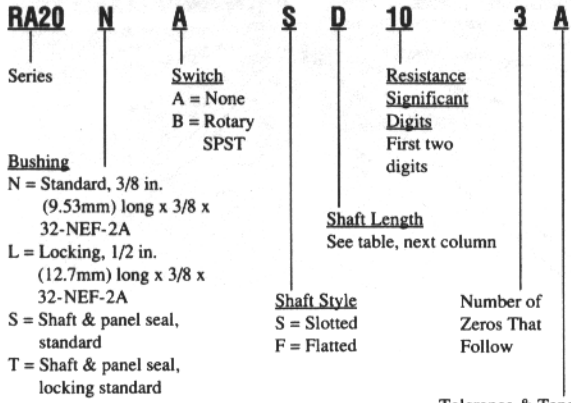

### Tolerance & Taper

A = ±10% Linear

\*C = Log CW ±10%

\*E = Log CCW ±10%

\*10% resistance at  
50% mechanical  
rotation. RA20: C & E  
application 10 ohm  
thru 5K ohm.

## Shaft Length from Mounting Surface

Shaft Length Code	Bushing N & S	Bushings L & T
A	1/2 in. (12.7mm)	N/A
B	N/A	5/8 in. (15.88mm)
D	7/8 in. (22.23mm)	7/8 in. (22.23mm)
G	1 1/4 in. (31.75mm)	1 1/4 in. (31.75mm)
K	2 1/2 in. (63.5mm)	N/A

N/A = Not available

## Series 45 How To Order

Series 45 available as special order only. Consult  
Factory for pricing, delivery and minimums.

Series A43/A43S

2 Watt

Pick-A-Shaft, Wirewound Potentiometer

Description

“Pick-A-Shaft” controls take any shaft listed on the next page including high voltage coupler and insulated shaft. Your choice of one of the 13 shafts listed (this does not include insulated shaft) with each control. If shaft is not specified, it will be supplied with RS-2. “A-43” is without switch while “A43S” has factory attached SPST switch. Tolerance  $\pm 10\%$  all values. All controls linear. Items not listed are special; prices and information on request. Controls with other than SPST switches are special; prices and information supplied upon request.

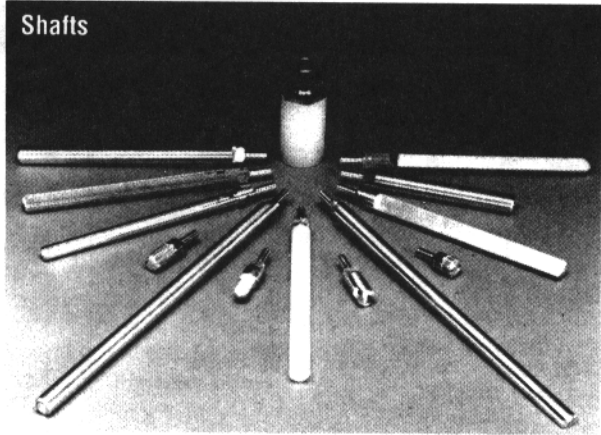
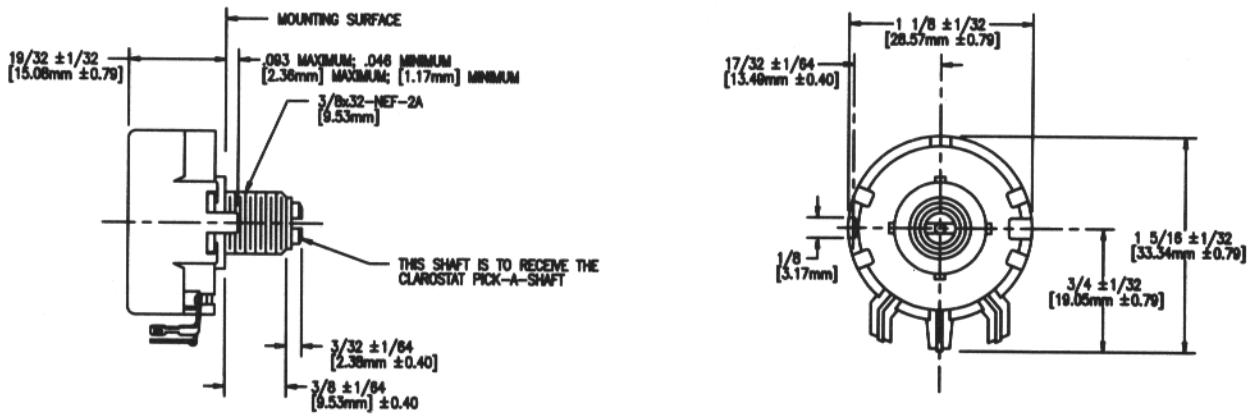

Figure 5

Series A43 Dimensions



Series A43 Standard Resistance Values

Stock Values

A43-5	A43-200	A43-4000
A43-10	A43-250	A43-5000
A43-20	A43-300	A43-7500
A43-25	A43-400	A43-10K
A43-30	A43-500	A43-15K
A43-40	A43-750	A43-20K
A43-50	A43-1000	A43-25K
A43-75	A43-1500	A43-30K
A43-100	A43-2000	A43-40K
A43-150	A43-3000	A43-50K

Figure 6

Series A43S Dimensions

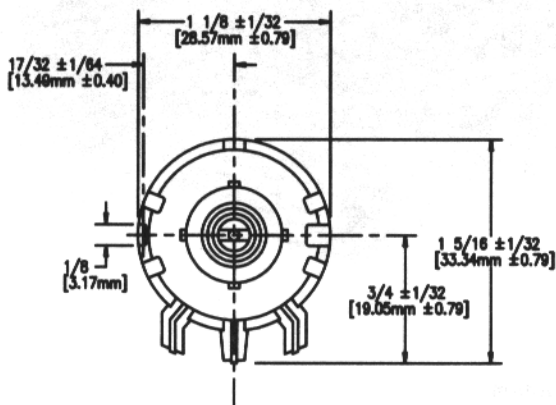
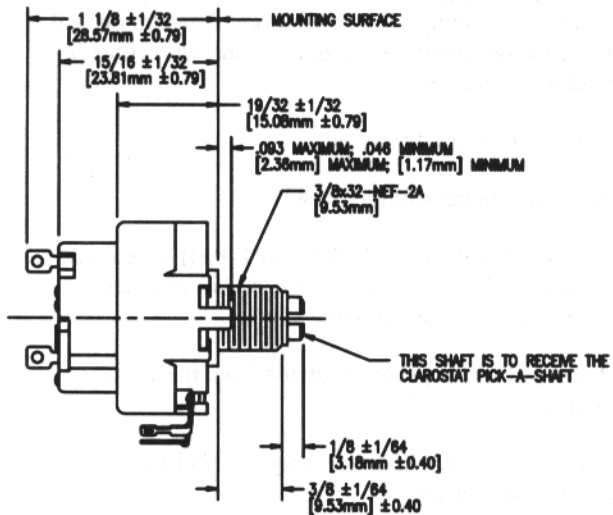

Series A43S Standard Resistance Values

Stock Values

A43S-5	A43S-100	A43S-1500
A43S-10	A43S-150	A43S-2000
A43S-20	A43S-200	A43S-2500
A43S-25	A43S-300	A43S-3000
A43S-30	A43S-400	A43S-4000
A43S-40	A43S-500	A43S-5000
A43S-50	A43S-750	A43S-7500
A43S-75	A43S-1000	A43S-10K

For use with all Clarostat "Pick-A-Shaft" controls either conductive plastic, or wirewound resistive element. Your choice of shaft furnished, at no extra charge, with each "Pick-A-Shaft" control.

Shafts

Catalog Number	Description
(1) SS-3/8	3/8 in. (9.53mm) long (Male) to take female fitting
(2) RS-2	Round shaft, 2 in. (50.8mm) long
(3) RS-3/16	Round slotted shaft 3/16 in. (4.76mm) diameter, 3 in. (76.2mm) long
(4) KSS-3	Knurled, split shaft, 3 in. (76.2mm) long
(5) RS-5	Round shaft, 5 in. (127mm) long
(6) FS-5	Flatted shaft, 5 in. (127mm) long
(7) KSS-5	Knurled, split shaft, 5 in. (127mm) long
(8) FS-3	Flatted shaft, 3 in. (76.2mm) long
(9) RS-3	Round shaft, 3 in. (76.2mm) long
(10) DFS-1/2	Double-flatted, Philco-type, 1/2 in. (12.7mm) long
(11) FKS-1/4	Fine-knurled, slotted shaft, 1/4 in. (6.35mm) long
(12) KFS-3	Knurled, flatted shaft, 3 in. (76.2mm) long
(13) FKS-1/2	Fine-knurled, slotted shaft, 1/2 in. (12.7mm) long

Catalog Number 59-186 — Spacer and Bushing Assemble. Catalog Number RN-3 — Non-Metallic Shaft Round 3 in. (76.2mm) long. High voltage shaft for operation up to 10K volts. Attaches to any Clarostat "Pick-A-Shaft" control.

Series A43/A43S How To Order

Series + Resistance value

Example: **A43-100**

**A43**  
Series 43 Pick-A-Shaft  
A43 = Without switch  
A43S = With SPST switch

**100**  
Resistance Value  
(Ohms)

How To Order/Shafts

Example: **RS-2**

**RS**  
Catalog Number  
See: Shafts (above)

**2**  
Length of Shaft  
Inches

## X-ON Electronics

Largest Supplier of Electrical and Electronic Components

*Click to view similar products for [Potentiometer Tools & Fixings](#) category:*

*Click to view products by [Honeywell](#) manufacturer:*

Other Similar products are found below :

[7071](#) [7071E](#) [7072E](#) [FKS-1/4](#) [H-38-3](#) [1220A](#) [ACCPOTDBB173190100](#) [H-858](#) [H-137-000](#) [H-38-1](#) [7090E](#) [7074E](#) [RK14K1240A4S](#)  
[HARDWARE](#) [H-37-4](#) [H-862](#) [100P8](#) [H-80-1](#) [RKZ00020NA](#) [34-1032-1A](#) [006-1-0](#) [1-150](#) [H-38-2](#) [H-37-1](#) [DA-01](#) [P0700-21](#) [P0700-7](#) [DA-02](#)  
[008T000](#) [T4845 13](#) [T4845 18](#) [T4857](#) [GSD-675](#) [H-114P](#) [H-83P](#) [H-90](#) [H-91](#) [DA-83](#) [DA-88](#) [6533E](#) [6591E](#) [7070E](#) [7091E](#) [5465](#)  
[RKZ00023UA](#) [ZB4BD912](#) [T4844](#) [T4847](#) [T4847 0](#) [T4856](#) [ACCPOTECEB303651550](#)