

## Interactive Catalog Supplements Catalog PDFs

If you need detailed product information, or help choosing the right product for your application, see our [Interactive Catalog](#). Use the [Interactive Catalog](#) to access the most complete and up-to-date information available.

The [Interactive Catalog](#) provides an extensive collection of product specifications, application data, and technical literature that can be searched based on criteria you select.

This PDF catalog information was published in November 2000.



Sensing and Control  
[Interactive  
Catalog...](#)

**Click this icon to try  
the Interactive Catalog.**

---

### Sensing and Control

Honeywell Inc.

11 West Spring Street

Freeport, IL 61032

power duty switching—for electrical versatility.

- Temperature range: -18° to 65°C (0° to 149°F).

#### ● MOUNTING FLEXIBILITY

Printed wiring board (PWB) mounted switches can be arranged in individual panel openings or multi-unit strips, in a common panel cutout. Optional support brackets provide added rigidity for stand-alone PWB mounted devices. Units with bezels and mounting clips can be snap-in mounted from the panel front.

Single level PWB or solder/quick-connect termination throughout makes wiring faster, easier, and more economical. Housings are designed to accommodate washing, before and after wave soldering, to help prevent contamination during printed wiring board installation.

cles, Hall effect ICs provide the ultimate in reliability.

Electronic control pushbutton or rocker switches, with gold or silver contacts, handle up to 1 amp; power duty switches, up to 6 amps.

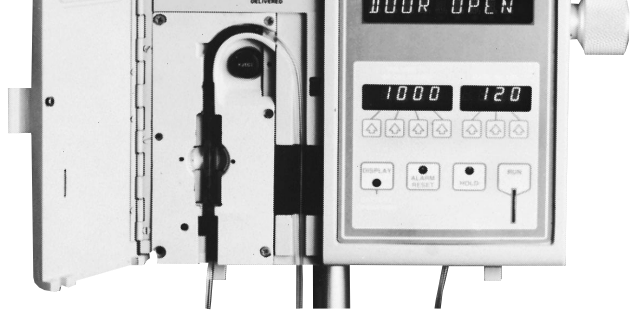

**MML medical application.** Intranavenous fluid flow controller automatically dispenses fluids for medications, therapy, and nutrition.



**MML communications application.** Mobile radio control keeps businesses in touch with employees on the road.

voltage Externally Applied to Output	-0.5 volt min. +28 Volts max. (Off condition)
Loads to Output	20 mA (Sinking)
Storage Temperature	-40° to +85°C (-40° to +185°F)
Operating Temperature	-18° to +65°C (0° to +149°F) and supply voltage of 4.5 to 5.5 VDC

As with all solid state components, performance can be expected to deteriorate as rating limits are approached; however, they will not be damaged unless the limits are exceeded.





**YS** Yellow\*  
**GS** Green\*

\* Permanently installed.

**DY** Yellow  
**DG** Green

For incandescent or non-lighted display:

**LR** Red  
**LY** Yellow  
**LG** Green  
**LW** White  
**LK** Black

Use Legend Order Sheet FO-74024 to cover each catalog listing (see page 69).

### **CUSTOMER INSTALLATION:**

#### **LED**

1. Order LED and receptacle, page 73.
2. Installation instructions, page 74/76.

#### **Incandescent Lamp**

1. Order lamp/PWB receptacle or lamp/solder receptacle, page 75.
2. Installation instructions, page 76.

<b>Gold Contacts:</b>	alt. action	<b>Gold contacts</b>	
<b>BA</b>	1 pole, mom. action	<b>BA</b>	1-pole, mom. action
<b>BB</b>	1 pole, alt. action	<b>BB</b>	1-pole, alt. action
<b>BC</b>	2 pole, mom. action		
<b>BD</b>	2 pole, alt. action		

## MML21 ONE PIECE LENS/PLUNGER SWITCHES ORDER GUIDE

Catalog listing codes for switch, less assembled display options

### MML21H

### K

### 3

### AA

Housing Type
<b>MML21K</b> Rectangular Black Housing
<b>MML21H</b> Square Black Housing

Mounting	
Rectangular	Square
<b>A</b> No bezel (PWB mounting)	<b>A</b> No bezel (PWB Mounting)
<b>K</b> Black bezel, mtg. clip/long sides	<b>R</b> Black bezel & mtg. clip

Terminals
<b>3</b> Printed Wiring Board
<b>2</b> Solder

Circuitry/Action (Each pole is double throw)	
Rectangular	Square
<b>Silver Contacts:</b>	<b>Silver contacts:</b>
<b>AA</b> 1 pole, mom. action	<b>AA</b> 1-pole, mom. action
<b>AB</b> 1 pole, alt. action	<b>AB</b> 1-pole, alt. action
<b>AC</b> 2 pole, mom. action	
<b>AD</b> 2 pole, alt. action	
<b>Gold Contacts:</b>	<b>Gold contacts</b>
<b>BA</b> 1 pole, mom. action	<b>BA</b> 1-pole, mom. action
<b>BB</b> 1 pole, alt. action	<b>BB</b> 1-pole, alt. action
<b>BC</b> 2 pole, mom. action	
<b>BD</b> 2 pole, alt. action	



**CUSTOMER INSTALLATION:****LED**

1. Order LED and receptacle, page 73.
2. Installation instructions, page 73/75.

**Incandescent Lamp**

1. Order lamp/PWB receptacle or lamp/solder receptacle, page 74.
2. Installation instructions, page 75.

LK Black

69.)

Order display options assembled to switch by adding codes below

**H****Button Color (One Piece Plunger)**

For LED Display		For Incandescent or non-light display	
<b>H</b>	Red	<b>R</b>	Red
<b>L</b>	Yellow	<b>Y</b>	Yellow
<b>N</b>	Green	<b>G</b>	Green
		<b>Z</b>	Black

**RS****LED\***

<b>XX</b>	No LED <sup>4</sup>
<b>RS</b>	Red <sup>5</sup>
<b>YS</b>	Yellow <sup>5</sup>
<b>GS</b>	Green <sup>5</sup>

**Legend**

**XX20**  
With Legend (Leave Blank if no legend needed)

Use Legend Order Sheet FO-74024 to cover each catalog listing. (See page 69.)

**\*Notes:**

1. When an LED is specified in a **rectangular** MML21 listing, MICRO SWITCH will permanently install it in the housing.
2. MICRO SWITCH does **not** permanently install an LED in a **square** MML21 listing. To install an LED in a square housing, order a MML93L or MML93G receptacle and a MML92 LED (see pages 86 and 88).
3. Include four digits (XXXX or XX DR) when a legend is required.
4. For square or rectangular only.
5. For rectangular only.



built ON in each position, black rocker, red lens for LED display in Side 1 and no lens in Side 2.

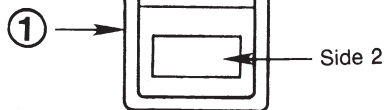

<b>3-Position</b>	<b>03</b>	Maint.	None	Mom.
	<b>04</b>	Maint.	Maint.	Maint.
	<b>05</b>	Mom.	Maint.	Mom.
	<b>07</b>	Mom.	Maint.	Maint.

Order display options assembled to switch by adding codes below.

**01**

**Action**  
Insert code numbers from Operating Action Chart

**H**

**Rocker**  
**K** Black rocker, non-lighted  
**H** Black rocker, one lens\*  
**F** White rocker, one lens\*  
 \* Lighted switches with solder terminals require MML93R receptacle to install lamps or LEDs. See page 76.

**DRXX**

Lens			
Side 1		Side 2	
<b>XX</b>	None	<b>XX</b>	None
LED display:	Incand. display:	LED display:	Incand. display:
<b>DR</b> Red	<b>LR</b> Red	<b>DR</b> Red	<b>LR</b> Red
<b>DY</b> Yellow	<b>LY</b> Yellow	<b>DY</b> Yellow	<b>LY</b> Yellow
<b>DG</b> Green	<b>LG</b> Green	<b>DG</b> Green	<b>LG</b> Green
	<b>LW</b> White		<b>LW</b> White

Leave blank, if legend not desired

**Legend**  
**20** With legend  
  
 Use legend order sheet FO-74193 to cover each catalog listing (see page 70).

**CUSTOMER INSTALLATION:**

**LED**

1. Order LED and receptacle, page 73.
2. Installation instructions, pages 74/76.

**Incandescent Lamp**

1. Order lamp/PWB receptacle or lamp/solder receptacle, page 75.
2. Installation instructions, page 76.

**MML31K**  
Black housing, non-lighted

**A** No bezel (PWB mounting)  
**K** Black bezel, mtg. clip/long sides

**3** Printed wiring board  
**2** Solder/Quick-connect

**AA** 1 pole, mom. action  
**AB** 1 pole, alt. action  
**AC** 2 poles, mom. action  
**AD** 2 poles, alt. action

LY	Yellow
LG	Green
LW	White
LK	Black

Use Legend Order Sheet FO-74024 to cover each catalog listing (see page 69).



PWB Mount



Panel Mount



PWB Mount



Panel Mount

- Bezels and mounting clips, LEDs and legended lenses can be furnished installed or ordered separately

## MML46 ORDER GUIDE

Catalog listing codes for indicator, less assembled display options

### MML46K

### A

### 3

Housing Type	
<b>Rectangular*</b> (1 or 2 LEDs or incand. lamps)	<b>Square*</b> (1 LED or incand. lamp)
<b>MML46K</b> Black housing	<b>MML46H</b> Black housing

Mounting	
<b>Rectangular:</b>	<b>Square:</b>
<b>A</b> No bezel (PWB mounting only)	<b>A</b> No bezel (PWB mounting only)
<b>K</b> Black bezel, mtg. clip/long sides	<b>R</b> Black bezel, mounting clips

Support Posts	
<b>3</b>	PWB ("A" mtg. only)
<b>2</b>	Solder**
<b>0</b>	None*** For snap-in and strip/matrix mount

\*\* Rectangular housings only.  
\*\*\* No LEDs allowed.

### \* Notes:

1. When an LED is specified in a **rectangular** MML46 listing, MICRO SWITCH will permanently install it in the housing.
2. MICRO SWITCH does **not** permanently install an LED in a **square** MML46 listing. To install an LED in a square housing, order a MML93L or MML93G receptacle and a MML92 LED (see pages 74 and 76).

**CUSTOMER INSTALLATION:**

**LED**

1. Order LED and receptacle, page 73.
2. Installation instructions, pages 74/76.

**Incandescent Lamp**

1. Order lamp/PWB receptacle or lamp/solder receptacle, page 75.
2. Installation instructions, page 76.

**LED TERMINATION**

If LEDs are to be permanently installed by MICRO SWITCH, please indicate by either a **2** (solder) or a **3** (PWB) for the Support Posts listing code. With MICRO SWITCH identification to the rear, the longest lead (+) anode will be to the left, closest to the double-pole circuit or support terminals.



Style 2



Style 3

Order display options assembled to indicator by adding codes below

**RSXX**

**LED (Stanley type)**

Available in rectangular housings only.

XXXX No LED

One LED\*: Two LEDs:

**RSXX** Red **RSRS** Red

**YSXX** Yellow **YSYS** Yellow

**GSXX** Green **GSGS** Green

**DR**

**Lens**

For LED display:

**DR** Red

**DY** Yellow

**DG** Green

For incandescent or non-lighted display:\*

**LR** Red

**LY** Yellow

**LG** Green

**LW** White

**LK** Black

Leave this space blank if legend not desired

**20**

**Legend**

**20** With legend

Use Legend Order Sheet FO-74024 to cover each catalog listing.

Square housings accept only one LED. Only a two-character LED code is necessary. Example: MML46HR0XXDY.

\* When ordering incandescent or non-lighted display, LED field must be XXXX.

**Rectangular Lenses:****MML52E**

Switch lens, LED display

**MML52G\***

Indicator lens

LED display

**Square Lenses:****MML52C**

Switch lens, LED display

**MML52D\*\***

Indicator lens, LED display

**Transmitted Color:****10** No legend**20** With legend**Illumination****LED Display:****R** Red**Y** Yellow**G** Green**C** Clear**Example: MML52G10Y**

LED display indicator lens; yellow transmitted color, no legend.

\* Use MML52E with MML41 rectangular pushbutton style indicators.

\*\* Use MML52D with MML41 square.

**HOW TO INSTALL LENSES**

Keytabs on two sides of the lenses mate with matching button slots.

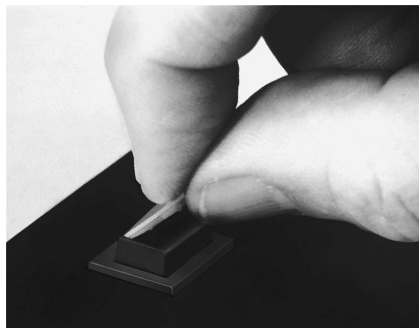
**Rectangular** lenses have tabs on the long sides. Seat a long side before snapping in place.**HOW TO INSTALL LENSES**

1. Seat lens.

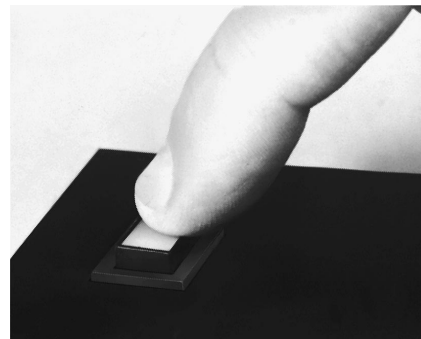

2. Snap in place.









2. Snap bezel onto mounting clip.

<b>MML73EA</b>	(long sides)
<b>MML73EB</b>	(short sides)

Recommended panel thickness for panel mounted units is .050 to .094 in. (1,27 to 2,39 mm).

---

lens, MML24 rocker lens rectangular button lens	MML92HRS MML92HGS MML92HYS	Red Green Yellow	1.7 V 2.1 V 2.2 V	2.0 V 2.5 V 2.5 V	ESBR3901 ESPY3901 ESAY3901
	MML92HRH MML92HGH MML92HYH	Red Green Yellow	2.2 V* 2.3 V* 2.2 V	<b>Hewlett Packard:</b> 3.0 V 3.0 V 3.0 V	HLMP-1340 HLMP-1540 HLMP-1440

Long lead: Anode (+). Short lead: Cathode (-).

\* @ 25 mA.

### MML93 LED PWB RECEPTACLE ORDER GUIDE

LED Type	Use to Illuminate	Catalog Listing
T-1 <sup>3/4</sup>	Rectangular button lens or umbrella button lens	MML93K
T-1	Square button lens or MML24 rocker lens	MML93G

### MML93 LED SOLDER TERMINAL ORDER GUIDE

LED Type	Use to Illuminate	Catalog Listing
T-1	Square button (base only)	MML93L
T-1	MML24 rocker lens (base only)	MML93R
T-1	Rectangular button (base and terminal)	MML93J

MML46 rectangular indicators only.

1. Insert solder terminal receptacle into hole in base of panel mount unit.

2. A  $\frac{1}{8}$ -turn clockwise applied to the receptacle locks it in the base.

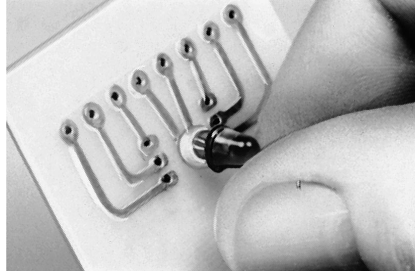

1. Assemble stand-off spacer to LED terminals and seat on printed wiring board.

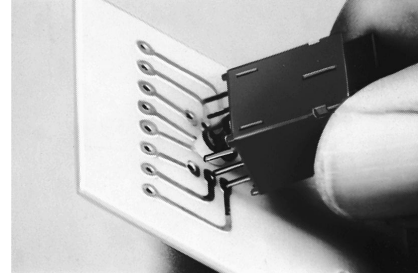

2. Seat housing on printed wiring board, with LED projecting into hole at the base of the housing.

### 4. By Soldering to Printed Wiring Board or Leadwire (MML44 indicators only).

T-1  $\frac{3}{4}$  LEDs are added to MML44 indicators via a procedure which is unique to this product. The LED is inserted from the top of the housing with the leadwires protruding through the housing base.

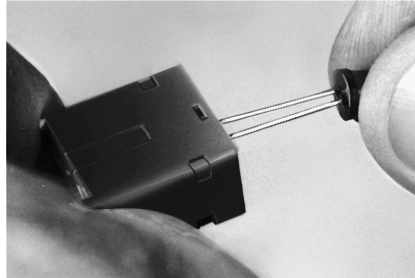

1. Assemble LED to MML44 indicator, with the LED terminals protruding through assembly slot in the middle of housing base.

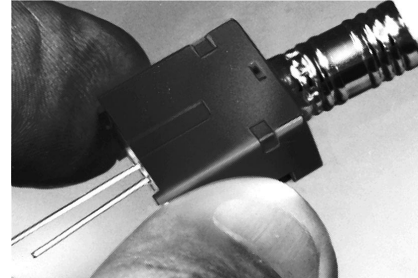

2. Use pencil eraser to snap LED securely in place.



only.

1. Insert solder terminal receptacle into hole in base of panel mount unit.

2. A  $\frac{1}{8}$ -turn clockwise applied to the receptacle locks it in the base.

### 3. With Solder Terminal Receptacles for MML93L/93R Unbased Only or T-1 LED.

Use the receptacles shown at right to install T-1 LEDs or T-1 unbased lamps in panel-mounted MML21 square pushbutton switches and MML24 rocker switches.

#### Procedure:

1. Assemble LEDs or lamps to receptacles (leads first).
2. Snap receptacle into slots in housing base.
3. Solder directly to leads.

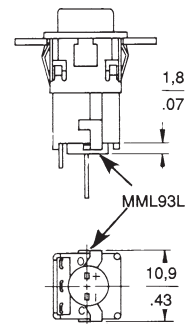
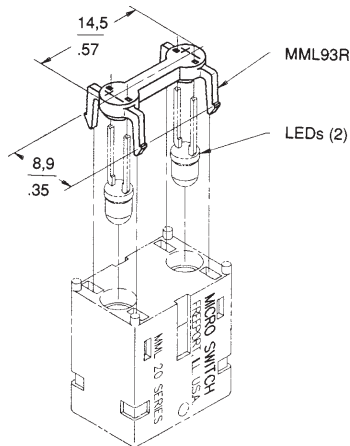



Establish tooling holes on X coordinate and use these holes to establish relationship between PWB and Panel

$$\text{Terminals } \frac{0,20}{.008} \times \frac{0,76}{.030}$$

$$\text{Recommended hole size in PWB } \frac{1,17}{.046}$$

N = Number of Switches

$$X = N-1 \times \frac{15,24}{.600} + \frac{15,11}{.595}$$

$$Y = \frac{10,16}{.400}$$

Example: N = 3 Switches

$$X = 5-1 \times \frac{15,24}{.600} + \frac{15,11}{.595}$$

$$X = \frac{76,07}{2,995}$$

### Vertical Mount

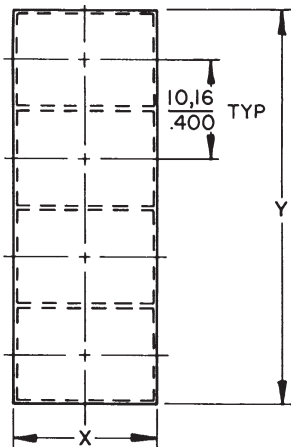

N = Number of Switches

$$Y = N \times \frac{10,16}{.400}$$

$$X = \frac{15,11}{.595}$$

Example: N = 4

$$Y = 4 \times \frac{10,16}{.400}$$

$$Y = \frac{40,64}{1,600}$$

$$\text{Terminals} \frac{.008}{.030} \times \frac{.400}{.030}$$

$$X = N \times \frac{.400}{.400}$$

$$X = \frac{50,80}{2,00}$$

$$\text{Recommended hole size in PWB} \frac{1,17}{.046}$$

### Vertical Mounting

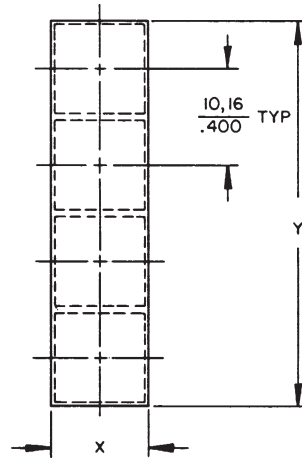

N = Number of Switches

$$\text{Formula: } Y = N \times \frac{10,16}{.400}$$

$$X = \frac{10,16}{.400}$$

Example: N = 4  
 $Y = 4 \times \frac{10,16}{.400}$   
 $Y = \frac{40,64}{1,600}$

### PWB Receptacle Installed (LED or Incandescent Lamp)

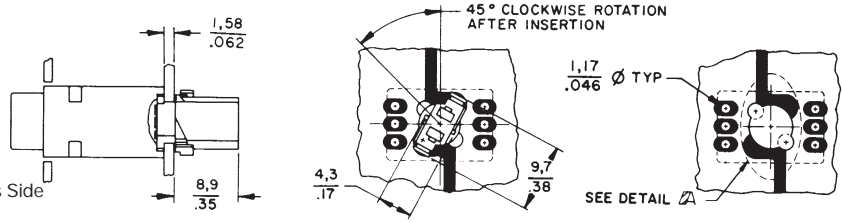

Notes:  
 △ MICRO SWITCH Identification This Side  
 2 – Linear measure mm/IN. or  $\frac{mm}{IN.}$

### MML31 Switches

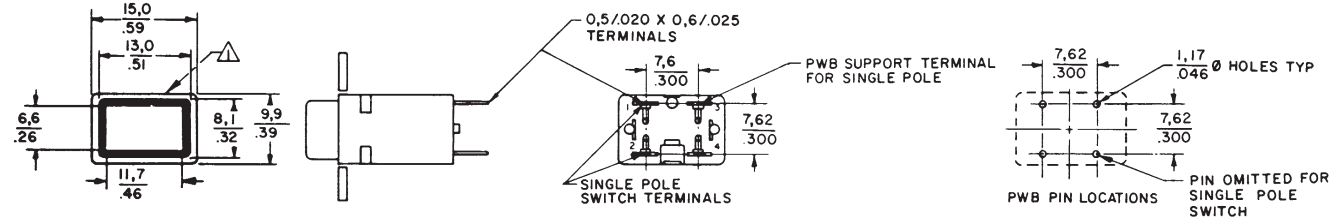

### PWB Receptacle Installed (LED or Incandescent Lamp)

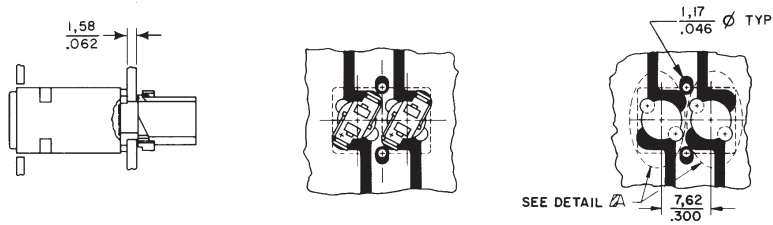

### PWB Pad Location For Receptacle (LED or Incandescent Lamp)

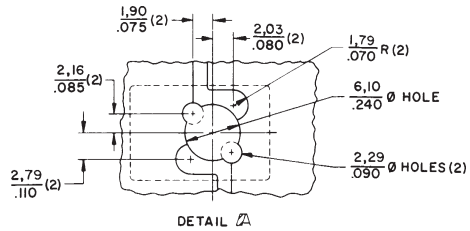

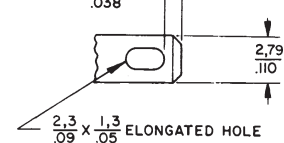
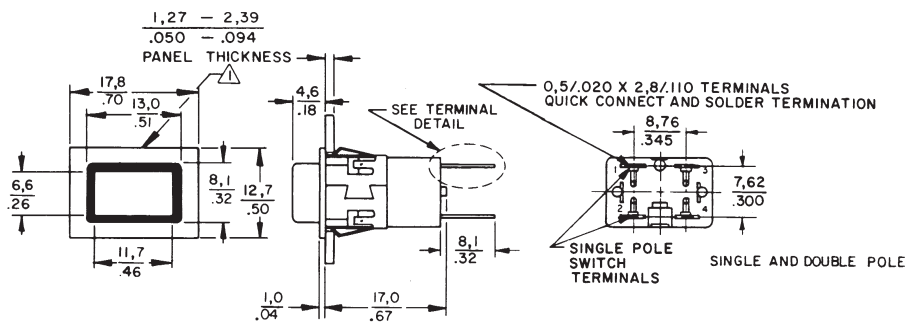

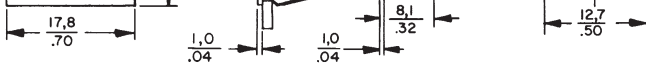

Notes:  
 ▲ MICRO SWITCH Identification This Side  
 2 – Linear measure mm/IN. or  $\frac{\text{mm}}{\text{IN.}}$

## MML46 Indicators

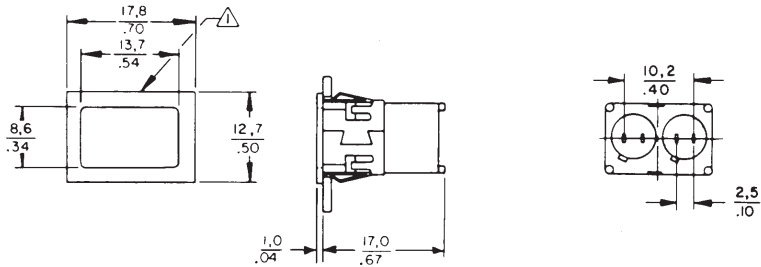

### Solder Receptacle Installed (LED or Incandescent Lamp)

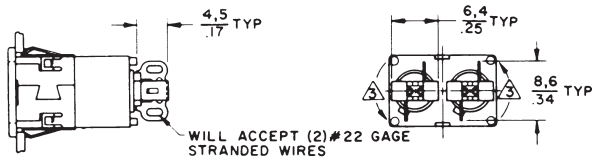

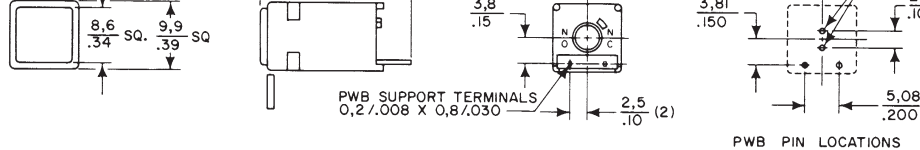

### PWB Receptacle Installed (LED or Incandescent Lamp)

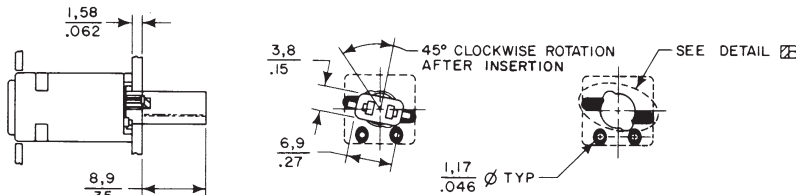

#### NOTES

△ MICRO SWITCH IDENTIFICATION THIS SIDE

△ MML41: 2.0 / .08

MML46: 1.0 / .04

3-LINEAR MEASURE mm/IN OR mm  
IN

## PANEL MOUNT PUSHBUTTON SWITCHES/SQUARE TYPE

### MML21 Switches

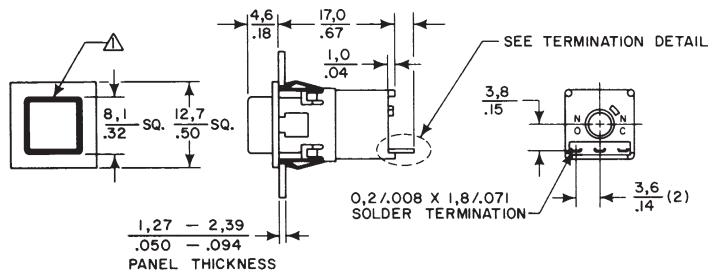

### Termination Detail

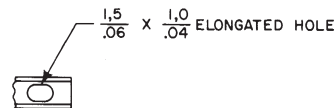

NOTE:  
To install LED or lamp, use MML93L receptacle shown on page 76.

# PWB SUPPORT BRACKETS

## Rectangular

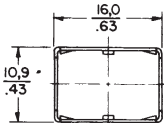

## Square

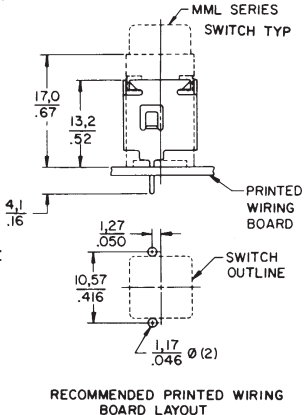
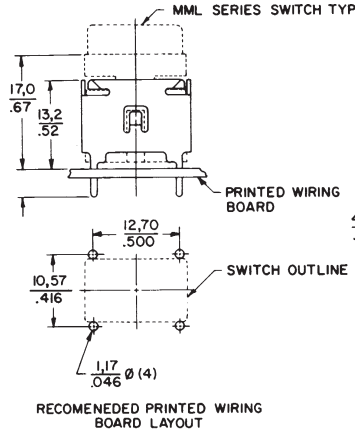
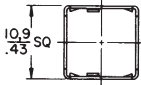



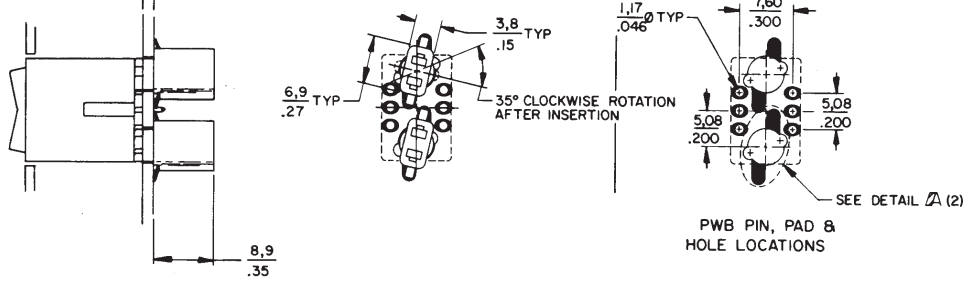

Notes:  
 △ MICRO SWITCH Identification  
 This Side  
 2 – Linear measure mm/IN. or  $\frac{\text{mm}}{\text{IN.}}$

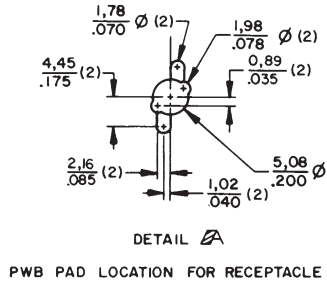



## X-ON Electronics

Largest Supplier of Electrical and Electronic Components

*Click to view similar products for [Pushbutton Switches](#) category:*

*Click to view products by [Honeywell](#) manufacturer:*

Other Similar products are found below :

[8940K2012](#) [LW1L-M1C10V-A](#) [LW1L-M1C70-A](#) [LW2L-A1C20M-GD](#) [LW2L-M1C20M-A](#) [60324L](#) [M22-D-R-GB0/K11](#) [M7E-HRN2](#)  
[67021K512](#) [67081K512X](#) [701PB580](#) [7190K101](#) [7199K101](#) [810K12910](#) [810KSV30B](#) [MML21EA2ADK](#) [MML21KA3ABK](#)  
[MML23KA3AC05K-001](#) [MML23KW3AA01W](#) [8418K2](#) [8442K3](#) [8450K1](#) [860K11911T01A](#) [861901](#) [861K11911T01A07](#)  
[861K13810T00A14](#) [861K13911](#) [8646AB6X718UL](#) [8646ABUL](#) [9001KXRK](#) [907AYY100](#) [PMHD155A1](#) [95-313.000](#)  
[9533CD4+U574+U4922](#) [95-414.000](#) [99-450.837](#) [99-453.837](#) [PV3H2B0NN-341](#) [1203MRA](#) [A22NZBGANGA](#) [A22NZBMMNGA](#)  
[A22NZBNANGA](#) [A22NZMPATRA](#) [A2PMA1X03EC56](#) [A3A-5123-02](#) [A3A-7140](#) [A3A-7310](#) [A3A-7340](#) [A3U-TMW-A2C-5M](#) [A595](#)