

Manual Switches

Miniature Manual Line

MML Series

MOUNTING DIMENSIONS (For reference only)

PANEL CUTOUTS FOR PUSHBUTTON SWITCHES AND INDICATORS/RECTANGULAR TYPE

INDIVIDUAL SNAP-IN PANEL MOUNT

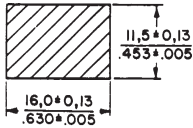

1,27 — 2,39
.050 — .094
Panel Thickness

PANEL PUNCH FOR MML SERIES

A panel punch is manufactured by Greenlee-Textron Tool Co., Rockford, IL (815-926-3011).

INDIVIDUAL PRINTED WIRING BOARD (PWB) MOUNT

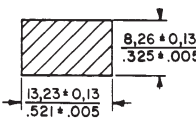

Pushbutton Plunger Thru Panel

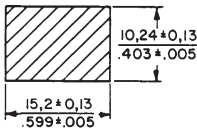

Housing Thru Panel

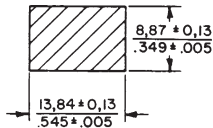

Indicator Lens Thru Panel

MULTI-UNIT PRINTED WIRING BOARD (PWB) MOUNT

Horizontal Mount

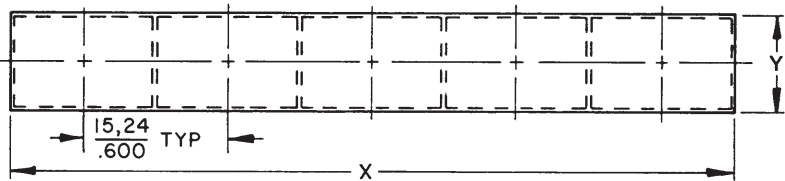
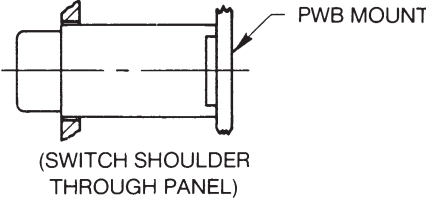

Establish tooling holes on X coordinate and use these holes to establish relationship between PWB and Panel

Terminals $\frac{0,20}{.008} \times \frac{0,76}{.030}$

Recommended hole size in PWB $\frac{1,17}{.046}$

N = Number of switches
 $X = N-1 \times \frac{15,24}{.600} + \frac{15,11}{.595}$
 $Y = \frac{10,16}{.400}$

Example: N = 5 Switches
 $X = 5-1 \times \frac{15,24}{.600} + \frac{15,11}{.595}$
 $X = \frac{76,07}{2,995}$

Vertical Mount

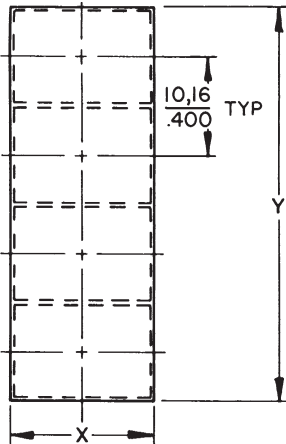

N = Number of Switches
 $Y = N \times \frac{10,16}{.400}$
 $X = \frac{15,11}{.595}$

Example: N = 4
 $Y = 4 \times \frac{10,16}{.400}$
 $Y = \frac{40,64}{1,600}$

Manuals

Manual Switches

Miniature Manual Line

MML Series

MOUNTING DIMENSIONS (For reference only)

PANEL CUTOUTS FOR PUSHBUTTON SWITCHES AND INDICATORS/SQUARE TYPE

Individual Snap-in Panel Mount

Individual Printed Wiring Board PWB Mount

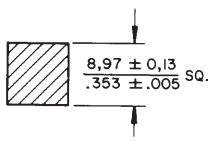
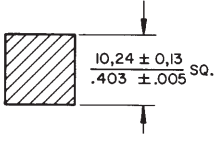
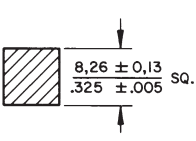
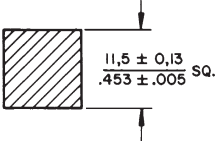

Pushbutton Plunger Thru Panel

Housing Thru Panel

Indicator Lens Thru Panel

See page 88 for panel punch manufacturer.

MULTI-UNIT PRINTED WIRING BOARD (PWB) MOUNT

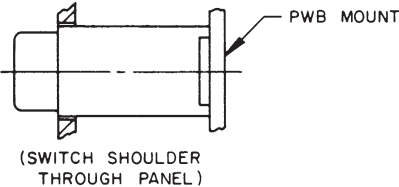

Establish tooling holes on X coordinate and use these holes to establish relationship between PWB and Panel

$$\text{Terminals } \frac{0,20}{.008} \times \frac{0,76}{.030}$$

Recommended hole size in PWB $\frac{1,17}{.046}$

Horizontal Mounting

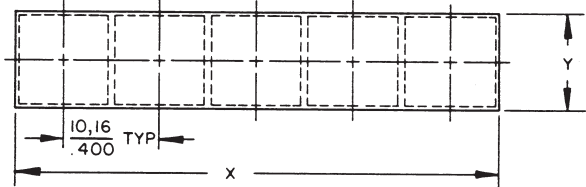

Formula:
 N = Number of switches
 $X = N \times \frac{10,16}{.400}$
 $Y = \frac{10,16}{.400}$

Example: N = 5 Switches
 $X = 5 \times \frac{10,16}{.400}$
 $X = \frac{50,80}{2.00}$

Vertical Mounting

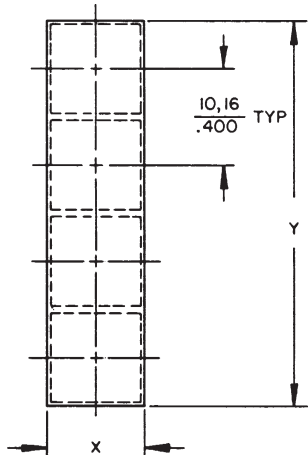

N = Number of Switches
 Formula: $Y = N \times \frac{10,16}{.400}$
 $X = \frac{10,16}{.400}$
 Example: N = 4
 $Y = 4 \times \frac{10,16}{.400}$
 $Y = \frac{40,64}{1.600}$

Manual Switches

Miniature Manual Line

MOUNTING DIMENSIONS (For reference only)

PRINTED WIRING BOARD MOUNT PUSHBUTTON SWITCHES/RECTANGULAR TYPE

MML11 Switches

PWB Pin Locations

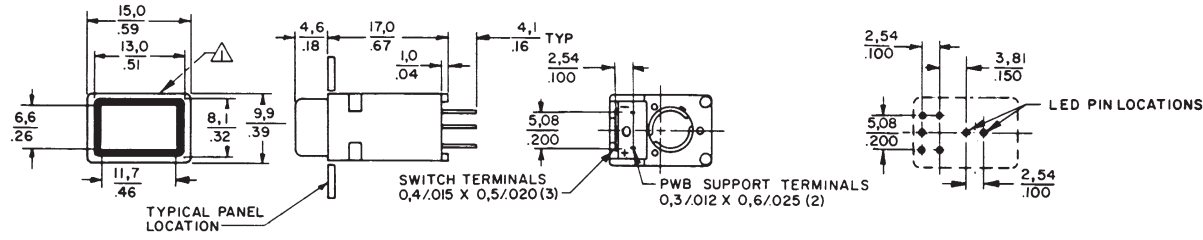

PWB Receptacle Installed (LED or Incandescent Lamp)

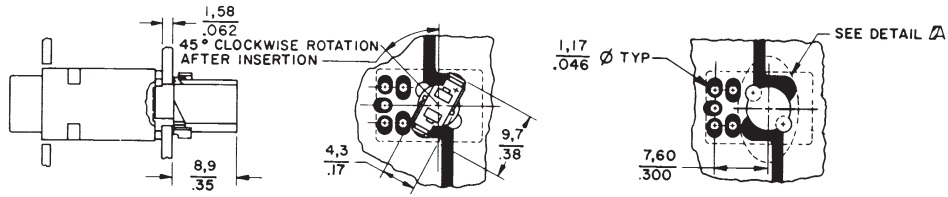

MML21 Switches

PWB Pin Locations

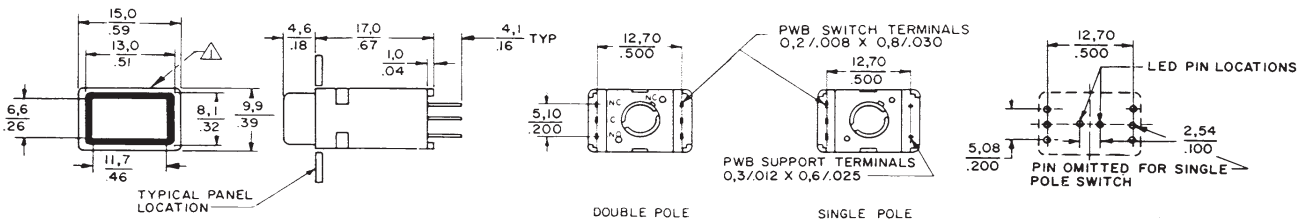

PWB Receptacle Installed (LED or Incandescent Lamp)

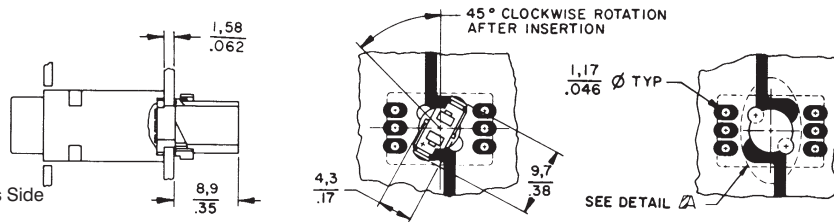

Notes:

△ MICRO SWITCH Identification This Side
 2 - Linear measure mm/IN. or $\frac{\text{mm}}{\text{IN.}}$

MML31 Switches

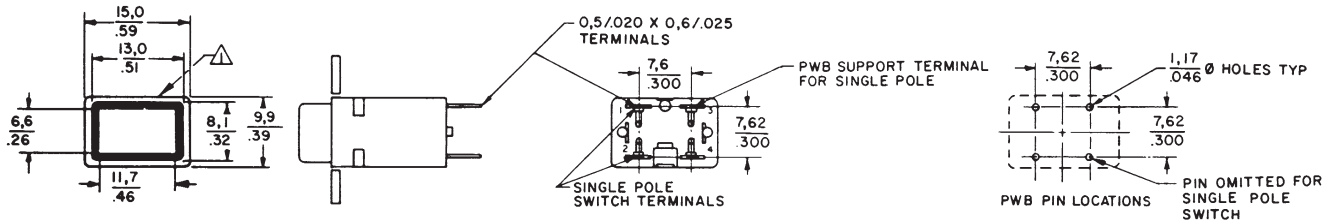

Manuals

Manual Switches

Miniature Manual Line

MML Series

MOUNTING DIMENSIONS (For reference only)

PRINTED WIRING BOARD MOUNT INDICATORS/RECTANGULAR TYPE

MML41 Indicators



PWB Receptacle Installed (LED or Incandescent Lamp)

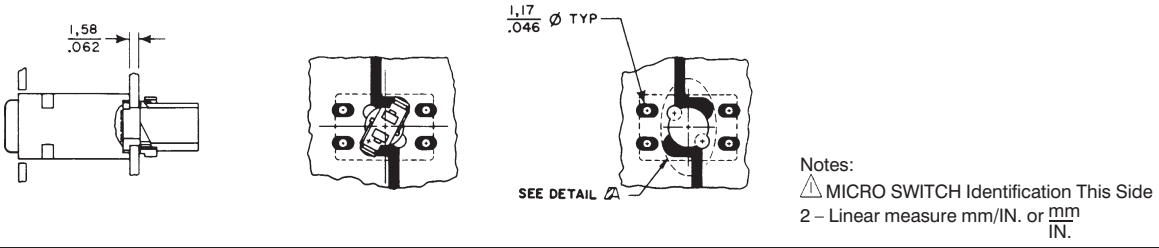

MML46 Indicators

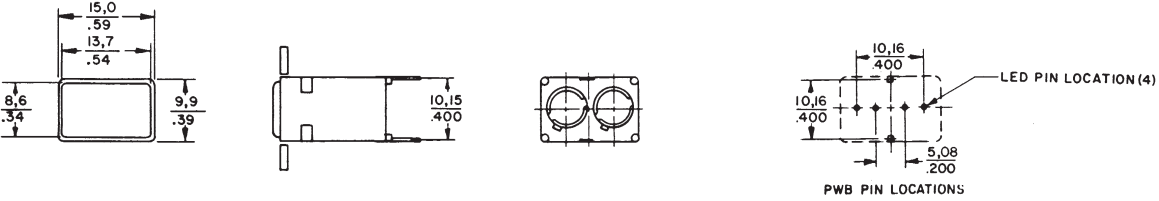

PWB Receptacle Installed (LED or Incandescent Lamp)

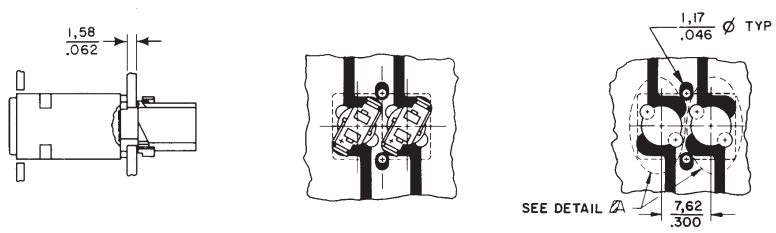

PWB Pad Location For Receptacle (LED or Incandescent Lamp)

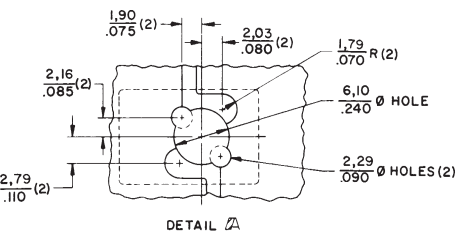

Manual Switches

Miniature Manual Line

MOUNTING DIMENSIONS (For reference only)

PANEL MOUNT PUSHBUTTON SWITCHES/RECTANGULAR TYPE

MML21 Switches

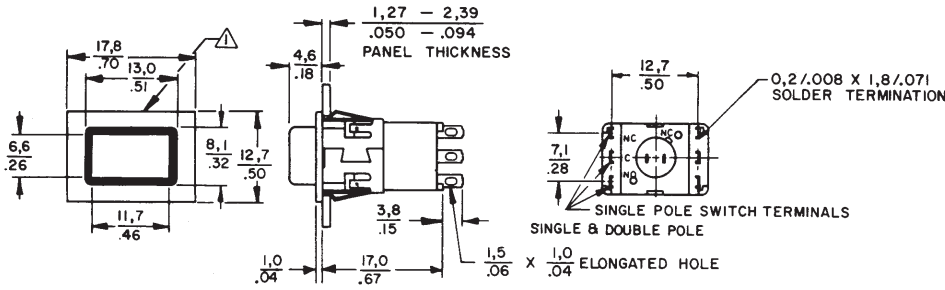

Solder Receptacle Installed (LED or Incandescent Lamp)

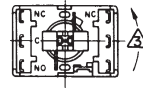
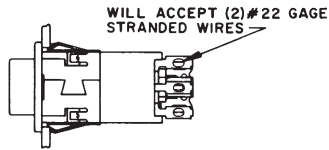

Notes:

- △ MICRO SWITCH Identification This Side
- 2 - Linear measure mm/IN. or $\frac{mm}{IN}$.
- △ Rotate 45° counter clockwise for removal from switch or indicator

MML31 Switches

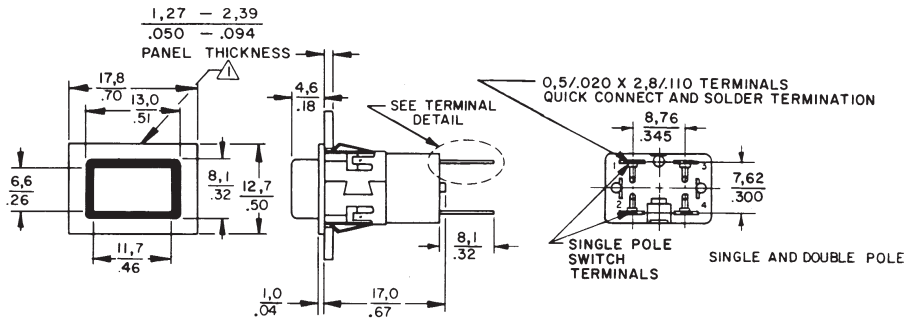

Terminal Detail

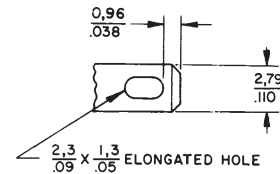

Manuals

Manual Switches

Miniature Manual Line

MOUNTING DIMENSIONS (For reference only)

PANEL MOUNT INDICATORS/RECTANGULAR TYPE

MML41 Indicators

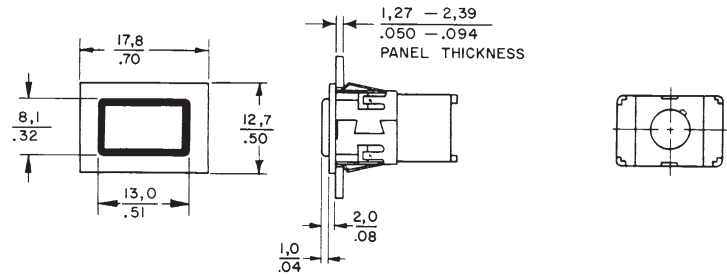

Solder Receptacle Installed (LED or Incandescent Lamp)

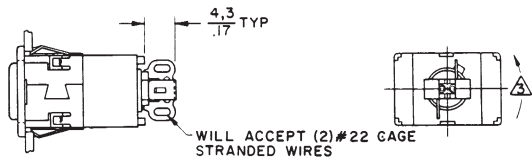

MML43 Indicators

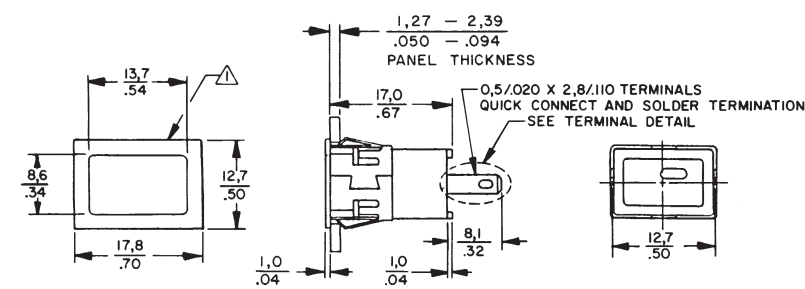

Terminal Detail

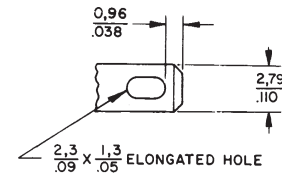

Notes:
 △ MICRO SWITCH Identification This Side
 2 - Linear measure mm/IN. or $\frac{mm}{IN}$.

MML46 Indicators

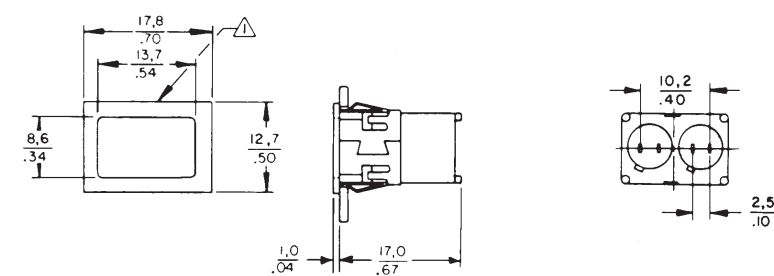

Solder Receptacle Installed (LED or Incandescent Lamp)

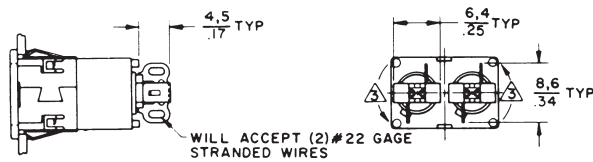

Manual Switches

Miniature Manual Line

MOUNTING DIMENSIONS (For reference only)

PRINTED WIRING BOARD MOUNT PUSHBUTTON SWITCHES AND INDICATORS/SQUARE TYPE

MML21 Switches

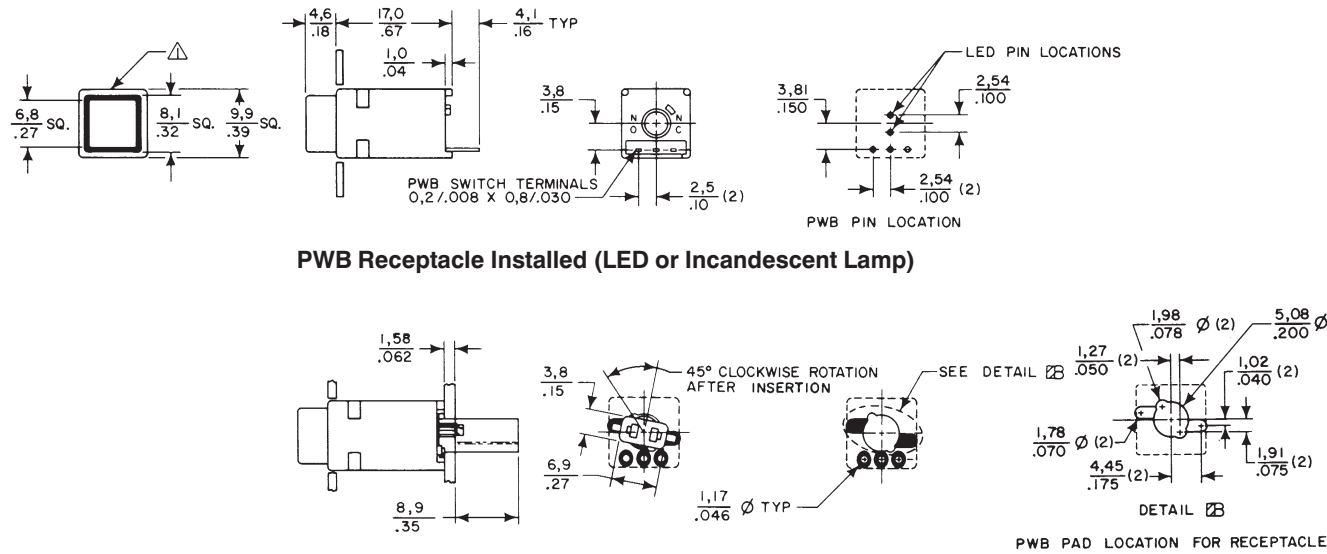

MML46 Indicators

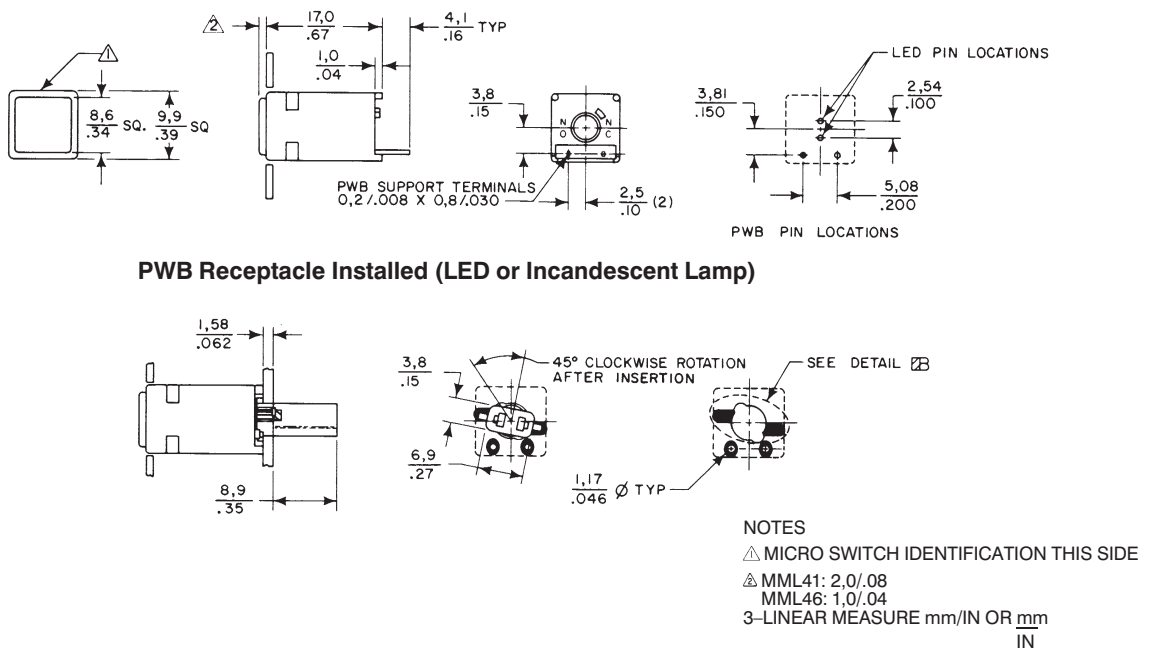

Manuals

PANEL MOUNT PUSHBUTTON SWITCHES/SQUARE TYPE

MML21 Switches

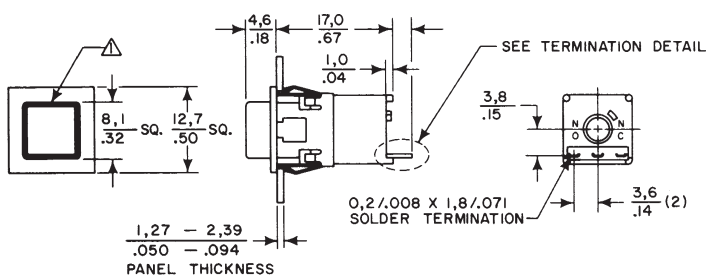

Termination Detail

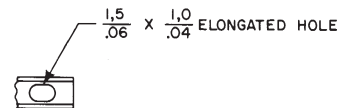

NOTE:
To install LED or lamp, use MML93L receptacle shown on page 88.

Manual Switches

Miniature Manual Line

MML Series

MOUNTING DIMENSIONS (For reference only)

LENSES

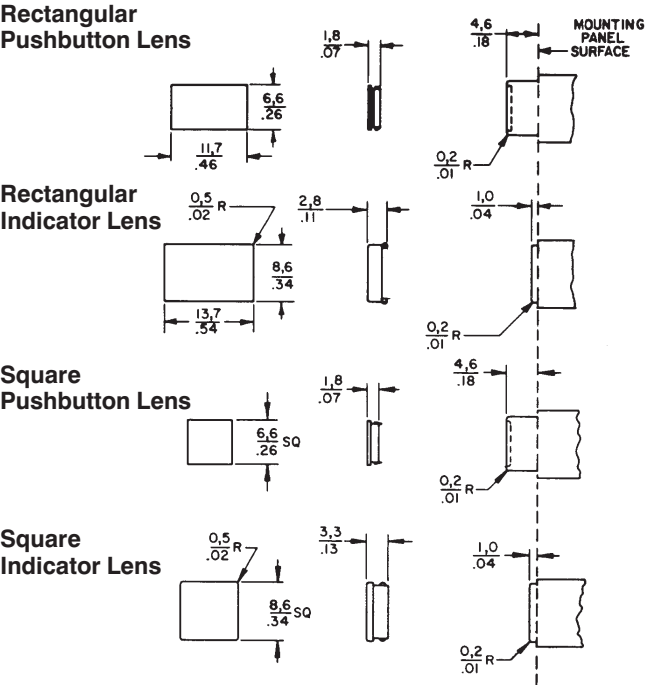

PWB SUPPORT BRACKETS

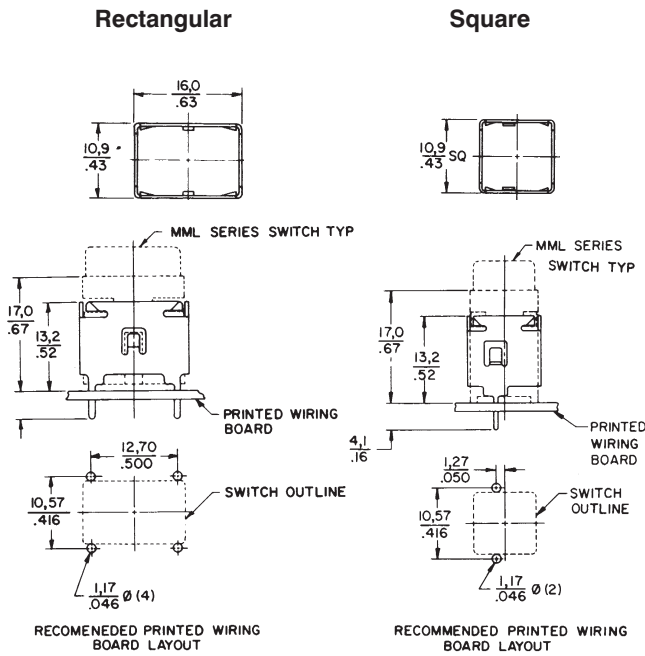

Manual Switches

Miniature Manual Line

MML Series

MOUNTING DIMENSIONS (For reference only)

PANEL CUTOUTS FOR PWB MOUNT PADDLE AND ROCKER SWITCHES

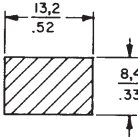

Actuator Thru Panel

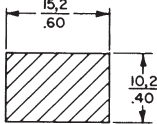

Housing Thru Panel

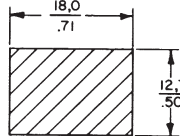

2-Pole MML33, 34 Actuator

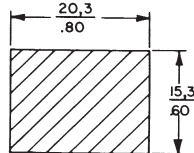

2-Pole MML33, 34 Thru Panel

Housing Thru Panel

See page 91 for panel punch manufacturer.

MML24 Rocker Switches

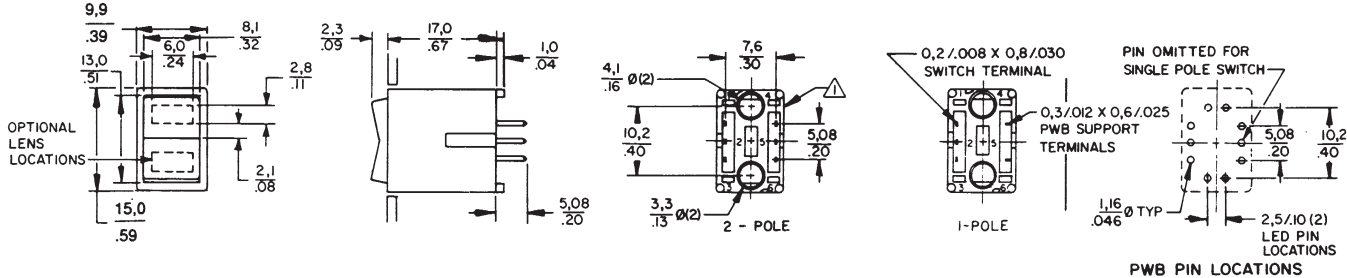

With PWB Receptacle Installed (LED or Incandescent Lamp)

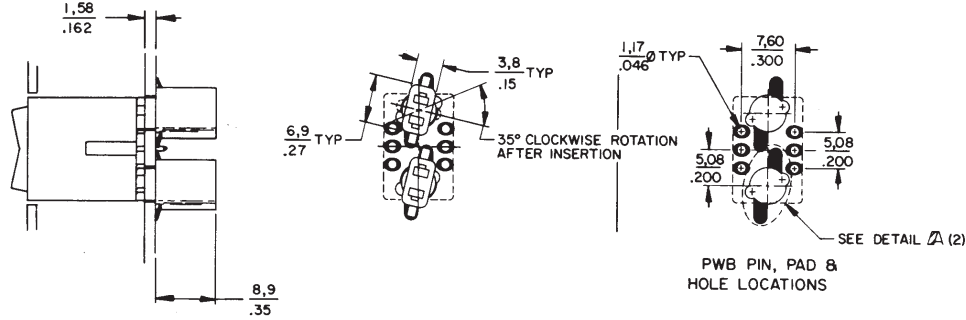

Notes:
 ▲ MICRO SWITCH Identification This Side
 2 - Linear measure mm/IN. or mm/IN.

Manuals

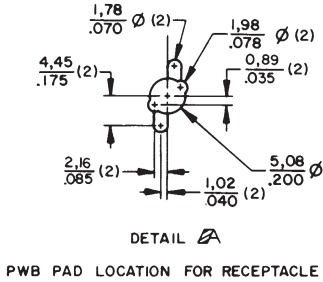

Manual Switches

Miniature Manual Line

MML Series

MOUNTING DIMENSIONS (For reference only)

PANEL MOUNT ROCKER SWITCHES

MML24 Rocker Switches

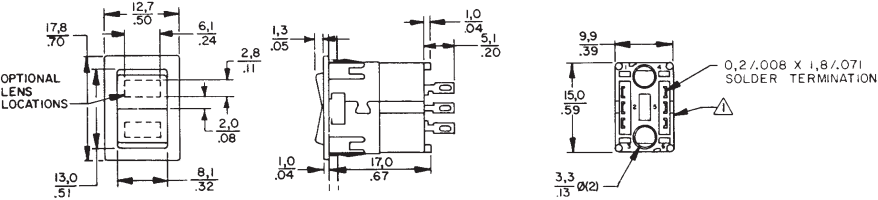

Notes:
 △ MICRO SWITCH Identification This Side
 2 – Linear measure mm/IN. or $\frac{mm}{IN}$.

NOTE:
 To install LED or lamp, use MML93R receptacle shown on page 87.

X-ON Electronics

Largest Supplier of Electrical and Electronic Components

Click to view similar products for [Switch Fixings](#) category:

Click to view products by [Honeywell](#) manufacturer:

Other Similar products are found below :

[893102000](#) [00-5150](#) [LZZ1A](#) [0098.9234](#) [M2PA-5011](#) [630155](#) [635401](#) [6PA113](#) [6PA147-E6](#) [6PA148-E6](#) [6PA32](#) [6PA9](#) [700106](#) [700109](#)
[700303A56](#) [700C1GRY](#) [700C2GRN](#) [704-6001](#) [704.960.9](#) [704.965.2](#) [704.965.6](#) [704.966.0](#) [7089-3](#) [710082-B11](#) [71M1048](#) [757200264](#)
[764300000](#) [MHU35](#) [MHU37](#) [807039-1](#) [825.003.011](#) [825.005.011](#) [825.053.011](#) [825.055.011](#) [826.000.071](#) [827.020.011](#) [827.400.021](#)
[835.900.023](#) [MML52C10C](#) [MML52E10C](#) [MML92HGH](#) [MML93K](#) [84211M02CNNS](#) [84212M02CNNS](#) [842.500.011](#) [843.000.011](#) [843187-000](#) [843487-000](#) [84-901](#) [84-902](#)