

SD1440

Silicon Phototransistor

FEATURES

- Compact, metal can coaxial package
- 24° (nominal) acceptance angle
- Wide sensitivity ranges
- Wide operating temperature range (-55°C to +125°C)
- Mechanically and spectrally matched to SE1450 and SE1470 infrared emitting diodes

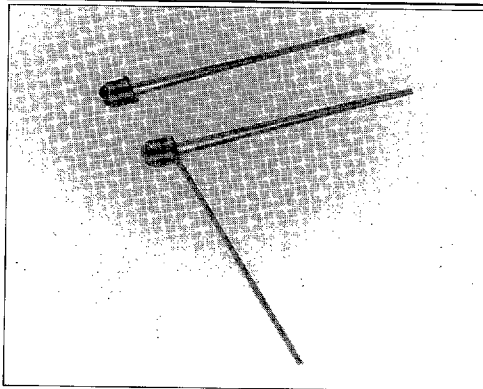

INFRA-63.TIF

DESCRIPTION

The SD1440 is an NPN silicon phototransistor mounted in a glass lensed metal can coaxial package. The package may have a tab or second lead welded to the can as an optional feature (SD1440-XXXL). Both leads are flexible and may be formed to fit various mounting configurations.

OUTLINE DIMENSIONS in inches (mm)

Tolerance 3 plc decimals $\pm 0.005(0.12)$
2 plc decimals $\pm 0.020(0.51)$

SD1440-XXX

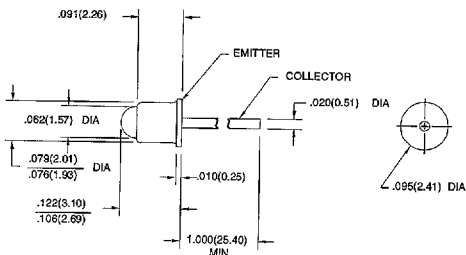

DIM_12a.dwg

SD1440-XXXL

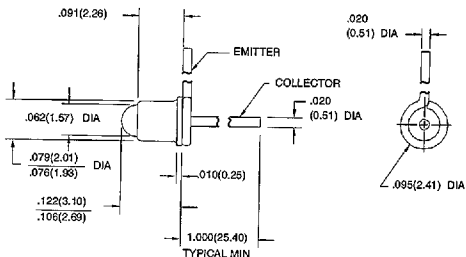

DIM_12b.dwg

SD1440

Silicon Phototransistor

ELECTRICAL CHARACTERISTIC (25°C unless otherwise noted)

PARAMETER	SYMBOL	MIN	TYP	MAX	UNITS	TEST CONDITIONS
Light Current SD1440-001, SD1440-001 L SD1440-002, SD1440-002 L SD1440-003, SD1440-003 L SD1440-004, SD1440-004 L	I_L	0.7 1.5 3.0 6.0			mA	$V_{CE}=5\text{ V}$ $H=5\text{ mW/cm}^2$ (1)
Collector Dark Current	I_{CEO}			100	nA	$V_{CE}=10\text{ V}$, $H=0$
Collector-Emitter Breakdown Voltage	$V_{(BR)CEO}$	30			V	$I_C=100\text{ }\mu\text{A}$
Emitter-Collector Breakdown Voltage	$V_{(BR)ECO}$	5.0			V	$I_E=100\text{ }\mu\text{A}$
Collector-Emitter Saturation Voltage	$V_{CE(SAT)}$			0.4	V	$I_C=0.4\text{ mA}$ $H=5\text{ mW/cm}^2$
Angular Response (2)	\emptyset		24		degr.	$I_F=\text{Constant}$
Rise And Fall Time	t_r, t_f		15		μs	$V_{CC}=5\text{ V}$, $I_C=1\text{ mA}$ $R_L=1000\text{ }\Omega$

Notes

- The radiation source is a tungsten lamp operating at a color temperature of 2870°K.
- Angular response is defined as the total included angle between the half sensitivity points.

ABSOLUTE MAXIMUM RATINGS

(25°C Free-Air Temperature unless otherwise noted)

Collector-Emitter Voltage	30 V
Emitter-Collector Voltage	5 V
Power Dissipation	75 mW (1)
Operating Temperature Range	-55°C to 125°C
Storage Temperature Range	-65°C to 150°C
Soldering Temperature (10 sec)	260°C

Notes

- Derate linearly from 25°C free-air temperature at the rate of 0.71 mW/°C.

SCHEMATIC

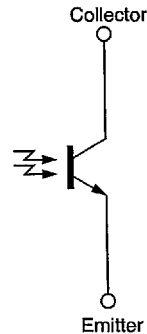

SD1440

Silicon Phototransistor

SWITCHING TIME TEST CIRCUIT

cir_015.cdr

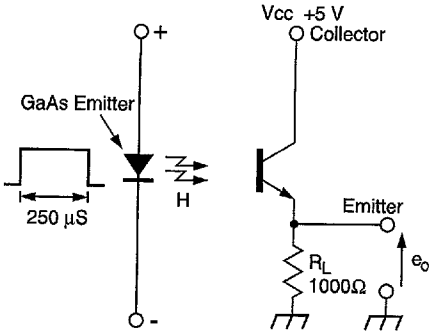

Fig. 1 Responsivity vs Angular Displacement

gra_051.ds4

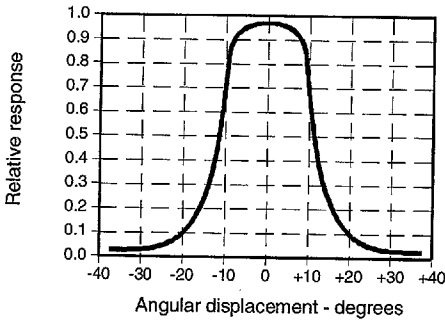
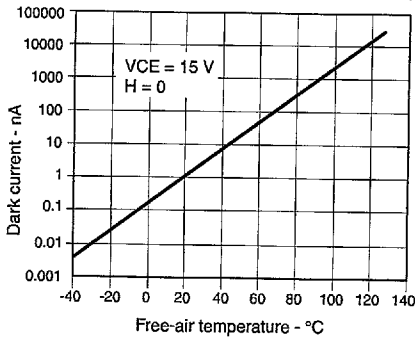

Fig. 3 Dark Current vs Temperature

gra_303.cdr



SWITCHING WAVEFORM

cir_004.cdr

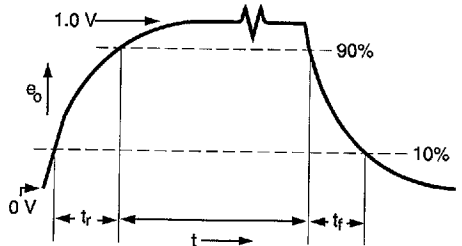

Fig. 2 Collector Current vs Ambient Temperature

gra_039.ds4

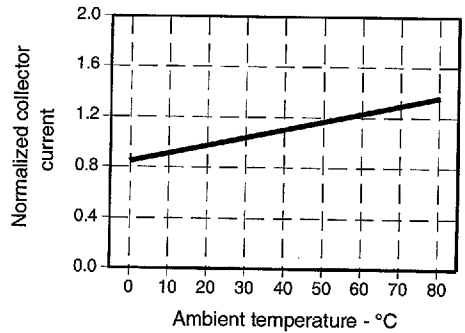
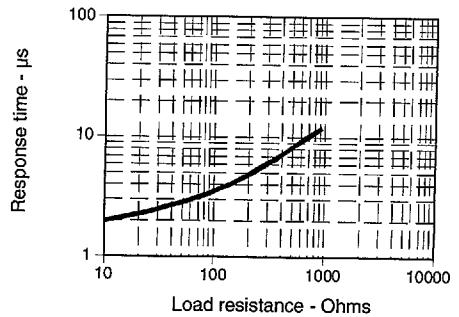

Fig. 4 Non-Saturated Switching Time vs Load Resistance

gra_041.ds4



4551830 0022528 T41

honeywell

Honeywell reserves the right to make changes in order to improve design and supply the best products possible.

SD1440

Silicon Phototransistor

Fig. 5 Spectral Responsivity

gra_038.ds4

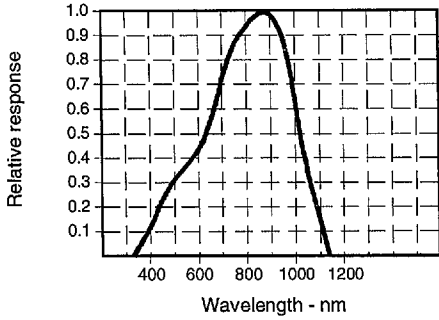
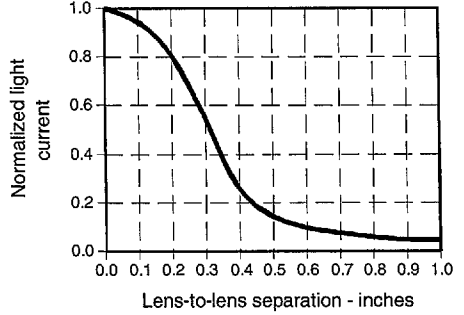

Fig. 6 Coupling Characteristics with SE1450

gra_006.ds4



All Performance Curves Show Typical Values

SD2440

Silicon Phototransistor

FEATURES

- Miniature, hermetically sealed, pill style, metal can package
- 48° acceptance angle
- Wide operating temperature range (-55°C to +125°C)
- Ideal for direct mounting to printed circuit boards
- Wide sensitivity ranges
- Mechanically and spectrally matched to SE2460 and SE2470 infrared emitting diodes

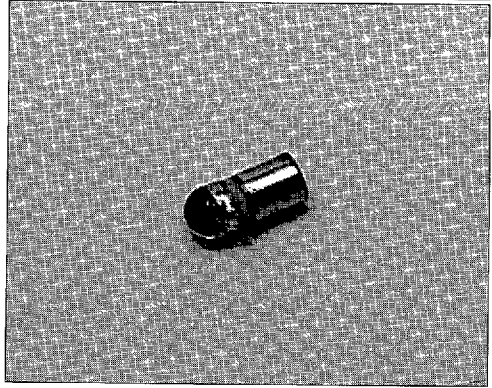

INFRA-1.TIF

DESCRIPTION

The SD2440 is an NPN silicon phototransistor mounted in a hermetically sealed glass lensed metal can package. This package directly mounts in a double sided PC board.

OUTLINE DIMENSIONS in inches (mm)

Tolerance 3 plc decimals $\pm 0.005(0.12)$
2 plc decimals $\pm 0.020(0.51)$

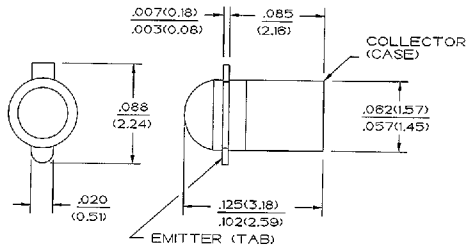

DIM_013.cdr

4551830 0022530 6TT

Honeywell

SD2440

Silicon Phototransistor

ELECTRICAL CHARACTERISTIC (25°C unless otherwise noted)

PARAMETER	SYMBOL	MIN	TYP	MAX	UNITS	TEST CONDITIONS
Light Current	I_L				mA	$V_{CE}=5\text{ V}$ $H=20\text{ mW/cm}^2$ (1)
SD2440-001		0.5				
SD2440-002		2.0				
SD2440-003		4.0				
SD2440-004		7.0				
Collector Dark Current	I_{CEO}			100	nA	$V_{CE}=10\text{ V}$, $H=0$
Collector-Emitter Breakdown Voltage	$V_{(BR)CEO}$	30			V	$I_C=100\text{ }\mu\text{A}$
Emitter-Collector Breakdown Voltage	$V_{(BR)ECO}$	5.0			V	$I_E=100\text{ }\mu\text{A}$
Collector-Emitter Saturation Voltage	$V_{CE(SAT)}$			0.4	V	$I_C=I_E/8$ $H=20\text{ mW/cm}^2$
Angular Response (2)	\emptyset		48		degr.	$I_F=\text{Constant}$
Rise And Fall Time	t_r, t_f		15		μs	$V_{CC}=5\text{ V}$, $I_L=1\text{ mA}$ $R_L=1000\text{ }\Omega$

Notes

1. The radiation source is a tungsten lamp operating at a color temperature of 2870°K.
2. Angular response is defined as the total included angle between the half sensitivity points.

ABSOLUTE MAXIMUM RATINGS

(25°C Free-Air Temperature unless otherwise noted)

Collector-Emitter Voltage	30 V
Emitter-Collector Voltage	5 V
Power Dissipation	125 mW (1)
Operating Temperature Range	-55°C to 125°C
Storage Temperature Range	-65°C to 150°C
Soldering Temperature (10 sec)	260°C

Notes

1. Derate linearly from 25°C free-air temperature at the rate of 1.19 mW/°C.

SCHEMATIC

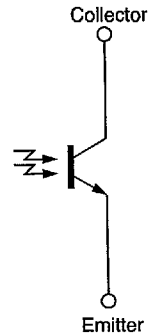

SD2440

Silicon Phototransistor

SWITCHING TIME TEST CIRCUIT

cir_015.cdr

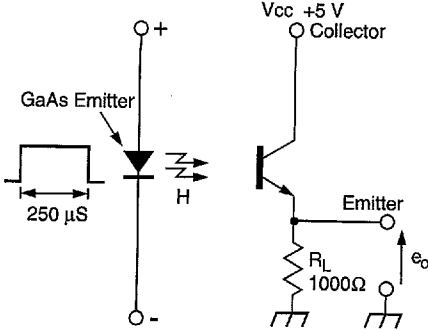

Fig. 1 Responsivity vs Angular Displacement

gra_037.ds4

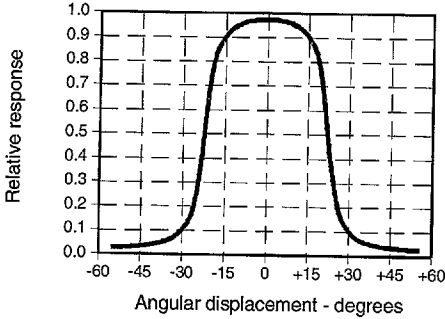
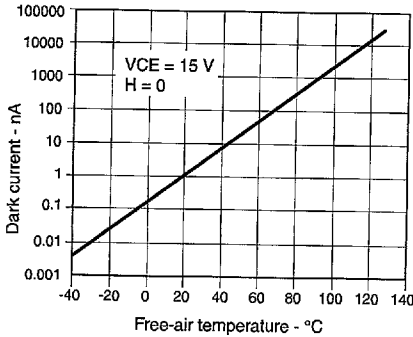

Fig. 3 Dark Current vs Temperature

gra_303.cdr



SWITCHING WAVEFORM

cir_004.cdr

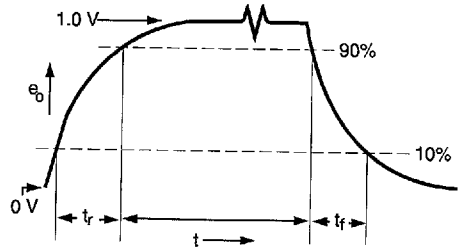

Fig. 2 Collector Current vs Ambient Temperature

gra_039.ds4

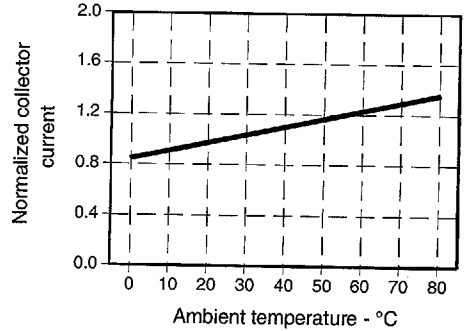
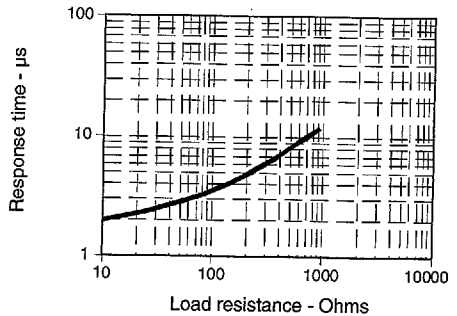

Fig. 4 Non-Saturated Switching Time vs Load Resistance

gra_041.ds4



4551830 0022532 472

Honeywell

Honeywell reserves the right to make changes in order to improve design and supply the best products possible.

SD2440

Silicon Phototransistor

Fig. 5 Spectral Responsivity

gra_036.d54

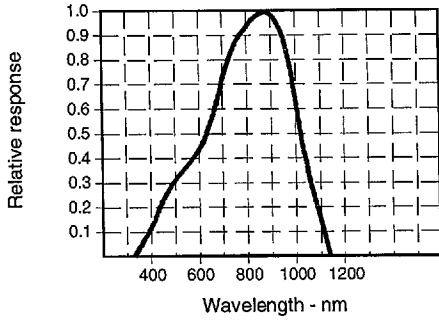
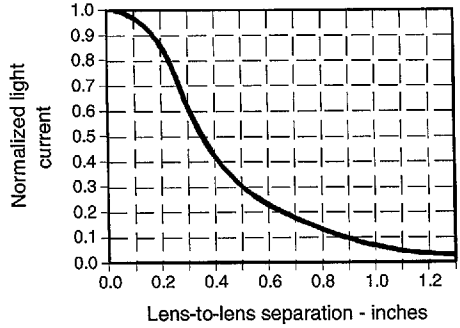

Fig. 6 Coupling Characteristics with SE2460

gra_015.d54



All Performance Curves Show Typical Values

Honeywell reserves the right to make changes in order to improve design and supply the best products possible.

4551830 0022533 309
Honeywell

X-ON Electronics

Largest Supplier of Electrical and Electronic Components

Click to view similar products for [Phototransistors](#) category:

Click to view products by [Honeywell](#) manufacturer:

Other Similar products are found below :

[LTR-5576D](#) [QSD123A4R0](#) [ASDL-6620-C22](#) [OED-ST-8LR2](#) [OED-STR44B90-TR](#) [SD5410-109](#) [PT91-21C/TR7](#) [PT91-21C/TR10](#)
[LKPT30102B-A01\(XY\)](#) [L-51ROPT1D1](#) [BP 103-3/4](#) [BPY 62](#) [KPS-3227SP1C](#) [L-53P3BT](#) [L-53P3C](#) [L-93DP3BT](#) [L-93DP3C](#) [LL-503PTC2E-1AD](#) [LL-S150PTC-1A](#) [SCM-014TBT86](#) [SFH 309-56](#) [SFH 310 FA](#) [SFH 320](#) [SFH 320-3](#) [SFH 320 FA](#) [SFH 320-Z](#) [SFH 3400-Z](#) [OP508FA](#)
[TEMT1030](#) [LTR-301](#) [PGM5516](#) [PGM5516-MP](#) [PGM5526-MP](#) [PGM5537-MP](#) [PGM5549](#) [PGM5549-MP](#) [PGM5637D](#) [PGM5639D](#) [KPA-3010P3C](#) [SFH 313 FA-34](#) [VEMT4700F-GS08](#) [OP830WSL](#) [PT19-21B/L41/TR8](#) [PT91-21C](#) [KP-2012P3C](#) [TEKT5400S](#) [RPT-37PB3F](#) [RPM-075PTT86](#) [SD1410-128L](#) [SFH 320 FA-4-Z](#)