

SD2440

Silicon Phototransistor

FEATURES

- Miniature, hermetically sealed, pill style, metal can package
- 48° acceptance angle
- Wide operating temperature range (- 55°C to +125°C)
- Ideal for direct mounting to printed circuit boards
- Wide sensitivity ranges
- Mechanically and spectrally matched to SE2460 and SE2470 infrared emitting diodes

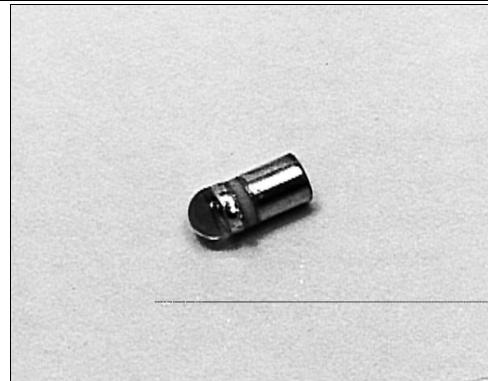

INFRA-1.TIF

DESCRIPTION

The SD2440 is an NPN silicon phototransistor mounted in a hermetically sealed glass lensed metal can package. This package directly mounts in a double sided PC board.

OUTLINE DIMENSIONS in inches (mm)

Tolerance 3 plc decimals ±0.005(0.12)
2 plc decimals ±0.020(0.51)

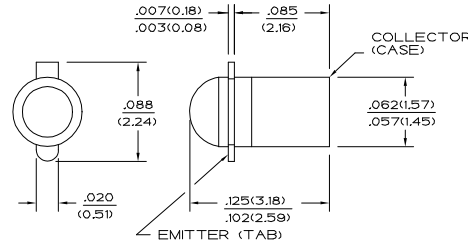

DIM_013.cdr

SD2440

Silicon Phototransistor

ELECTRICAL CHARACTERISTICS (25°C unless otherwise noted)

PARAMETER	SYMBOL	MIN	TYP	MAX	UNITS	TEST CONDITIONS
Light Current SD2440-001 SD2440-002 SD2440-003 SD2440-004	I_L	0.5 2.0 4.0 7.0			mA	$V_{CE}=5\text{ V}$ $H=20\text{ mW/cm}^2$ (1)
Collector Dark Current	I_{CEO}			100	nA	$V_{CE}=10\text{ V}$, $H=0$
Collector-Emitter Breakdown Voltage	$V_{(BR)CEO}$	30			V	$I_C=100\text{ }\mu\text{A}$
Emitter-Collector Breakdown Voltage	$V_{(BR)ECO}$	5.0			V	$I_E=100\text{ }\mu\text{A}$
Collector-Emitter Saturation Voltage	$V_{CE(SAT)}$			0.4	V	$I_C=I_L/8$ $H=20\text{ mW/cm}^2$
Angular Response (2)	\varnothing		48		degr.	$I_F=\text{Constant}$
Rise And Fall Time	t_r, t_f		15		μs	$V_{CC}=5\text{ V}$, $I_L=1\text{ mA}$ $R_L=1000\text{ }\Omega$

Notes

- The radiation source is a tungsten lamp operating at a color temperature of 2870°K.
- Angular response is defined as the total included angle between the half sensitivity points.

ABSOLUTE MAXIMUM RATINGS

(25°C Free-Air Temperature unless otherwise noted)

Collector-Emitter Voltage	30 V
Emitter-Collector Voltage	5 V
Power Dissipation	125 mW (1)
Operating Temperature Range	-55°C to 125°C
Storage Temperature Range	-65°C to 150°C
Soldering Temperature (10 sec)	260°C

Notes

- Derate linearly from 25°C free-air temperature at the rate of 1.19 mW/°C.

SCHEMATIC

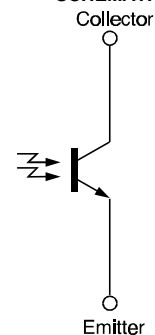

Honeywell reserves the right to make changes in order to improve design and supply the best products possible.

Honeywell

SD2440

Silicon Phototransistor

SWITCHING TIME TEST CIRCUIT

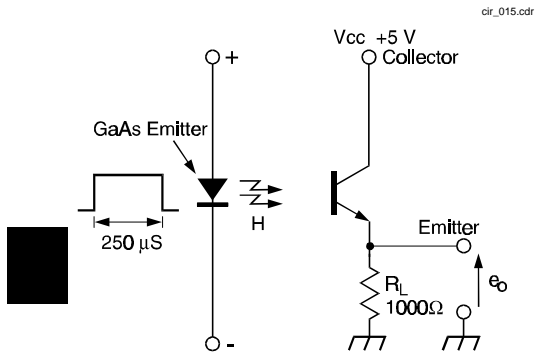

Fig. 1 Responsivity vs Angular Displacement

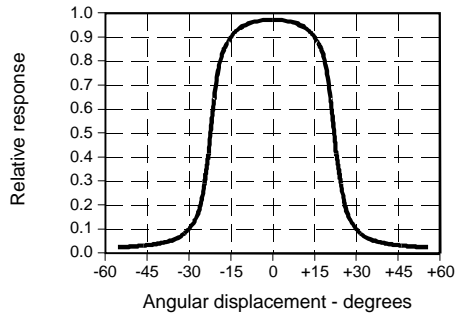
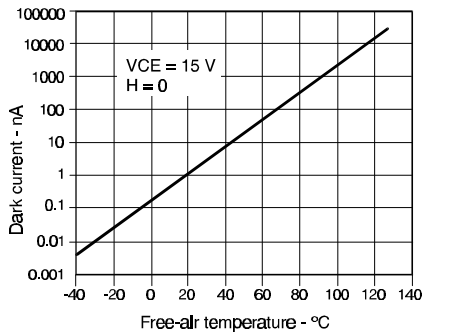

Fig. 3 Dark Current vs Temperature



SWITCHING WAVEFORM

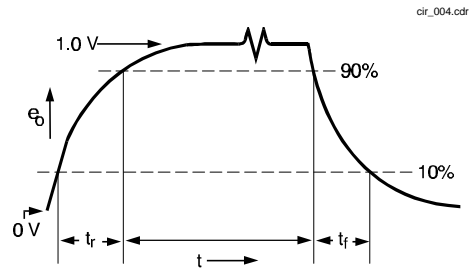

Fig. 2 Collector Current vs Ambient Temperature

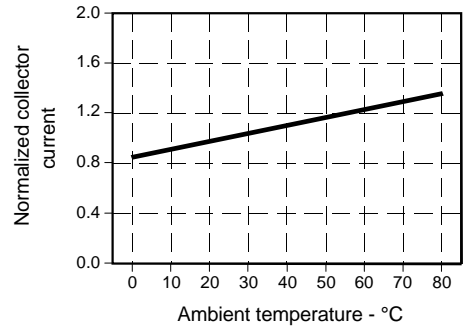
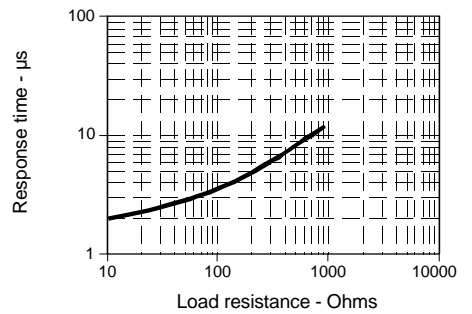

Fig. 4 Non-Saturated Switching Time vs Load Resistance



SD2440

Silicon Phototransistor

Fig. 5 Spectral Responsivity

gra_036.ds4

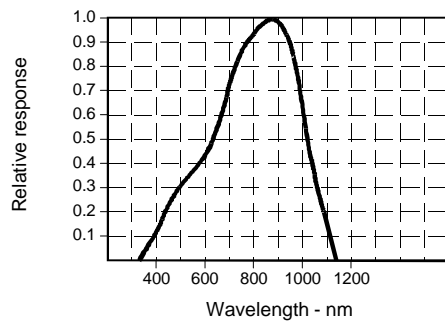
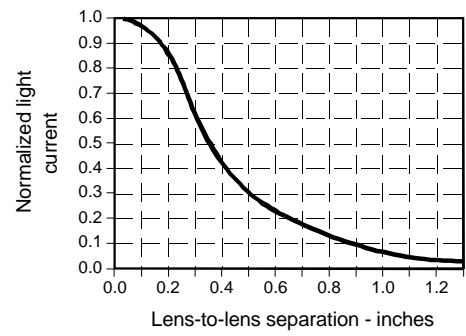

Fig. 6 Coupling Characteristics with SE2460

gra_015.ds4



All Performance Curves Show Typical Values

X-ON Electronics

Largest Supplier of Electrical and Electronic Components

Click to view similar products for [Phototransistors](#) category:

Click to view products by [Honeywell](#) manufacturer:

Other Similar products are found below :

[LTR-5576D](#) [PT17-21B/L41/TR8](#) [PT908-7B-F](#) [QSD123A4R0](#) [ASDL-6620-C22](#) [OED-ST-8LR2](#) [OED-STR44B90-TR](#) [SD5410-109](#) [PT26-21C/CT](#) [PT15-21B-TR8](#) [PT-IC-AC-3528-520](#) [PT-IC-BC-3528-550](#) [MHT153PTBT](#) [MHS153PTBT](#) [PT5529B/L2/H2-F](#) [PT91-21C/TR10](#) [BP103-3/4](#) [BPX 38-3](#) [BPY 62](#) [KPS-3227SP1C](#) [L-53P3BT](#) [L-53P3C](#) [L-93DP3BT](#) [L-93DP3C](#) [LL-503PTC2E-1AD](#) [LL-S150PTC-1A](#) [LL-S150PTD-1A](#) [SFH 320](#) [SFH 320-3](#) [SFH 320 FA](#) [OP508FA](#) [TEMT1030](#) [LTR-301](#) [PGM5516-MP](#) [PGM5526-MP](#) [PGM5549](#) [PGM5637D](#) [VTT7125H](#) [VEMT4700F-GS08](#) [PT19-21B/L41/TR8](#) [KP-2012P3C](#) [TEKT5400S](#) [SD1410-128L](#) [SFH 313 FA-3/4](#) [SFH 313 FA-2/3](#) [SFH 320-4-Z](#) [SFH 309 FA-5/6](#) [PT4800FE000F](#) [SFH 309-5/6](#) [SFH 3410-1/2-Z](#)