

SD3443/5443

Silicon Phototransistor

FEATURES

- TO-46 metal can package
- Choice of flat window or lensed package
- 90° or 18° (nominal) acceptance angle option
- Wide operating temperature range (-55°C to +125°C)
- External base connection for added control
- High sensitivity
- Mechanically and spectrally matched to SE3450/5450, SE3455/5455 and SE3470/5470 infrared emitting diodes

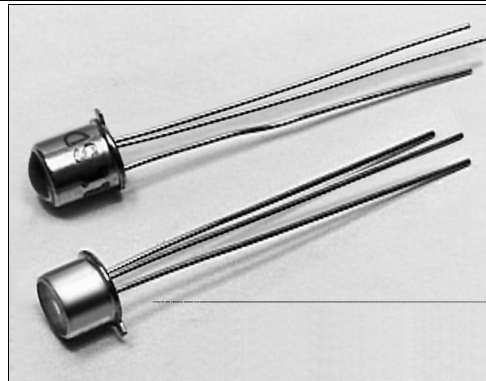

INFRA-57.TIF

DESCRIPTION

The SD3443/5443 series consists of an NPN silicon phototransistor mounted in a TO-46 metal can package. The SD3443 has flat window cans providing a wide acceptance angle, while the SD5443 has glass lensed cans providing a narrow acceptance angle. The TO-46 packages are ideally suited for operation in hostile environments.

The base is connected on all SD3443 and SD5433 standard products.

OUTLINE DIMENSIONS in inches (mm)

Tolerance	3 plc decimals	±0.005(0.12)
	2 plc decimals	±0.020(0.51)

SD3443

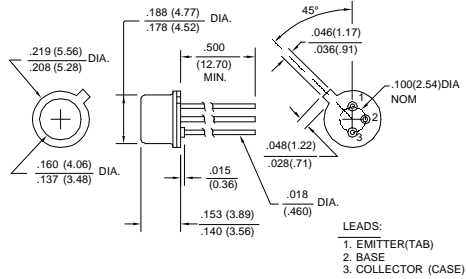

DIM_015.ds4

SD5443

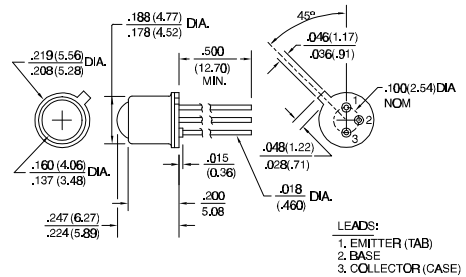

DIM_15b.ds4

SD3443/5443

Silicon Phototransistor

ELECTRICAL CHARACTERISTICS (25°C unless otherwise noted)

PARAMETER	SYMBOL	MIN	TYP	MAX	UNITS	TEST CONDITIONS
Light Current	I_L				mA	$V_{CE}=5\text{ V}$ $H=5\text{ mW/cm}^2$ (1)
SD3443-001		0.50				
SD3443-002		1.00				
SD3443-003		2.00				
SD5443-001		1.00				
SD5443-002		4.00				
SD5443-003		8.00				
SD5443-004	16.0					
Collector Dark Current	I_{CEO}			100	nA	$V_{CE}=10\text{ V}, H=0$
Collector-Emitter Breakdown Voltage	$V_{(BR)CEO}$	30			V	$I_C=100\text{ }\mu\text{A}$
Emitter-Collector Breakdown Voltage	$V_{(BR)ECO}$	5.0			V	$I_E=100\text{ }\mu\text{A}$
Collector-Emitter Saturation Voltage	$V_{CE(SAT)}$			0.4	V	$I_C=0.4\text{ mA}$ $H=5\text{ mW/cm}^2$
Angular Response (2)	\emptyset				degr.	$I_F=\text{Constant}$
SD3443			90			
SD5443			18			
Rise And Fall Time	t_r, t_f		15		μs	$V_{CC}=5\text{ V}, I_L=1\text{ mA}$ $R_L=1000\text{ }\Omega$

Notes

- The radiation source is a tungsten lamp operating at a color temperature of 2870°K.
- Angular response is defined as the total included angle between the half sensitivity points.

ABSOLUTE MAXIMUM RATINGS

(25°C Free-Air Temperature unless otherwise noted)

Collector-Emitter Voltage	30 V
Emitter-Collector Voltage	5 V
Power Dissipation	150 mW (1)
Operating Temperature Range	-55°C to 125°C
Storage Temperature Range	-65°C to 150°C
Soldering Temperature (10 sec)	260°C

Notes

- Derate linearly from 25°C free-air temperature at the rate of 1.43 mW/°C.

SCHEMATIC

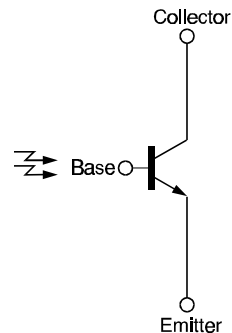

Honeywell reserves the right to make changes in order to improve design and supply the best products possible.

Honeywell

SD3443/5443

Silicon Phototransistor

SWITCHING TIME TEST CIRCUIT

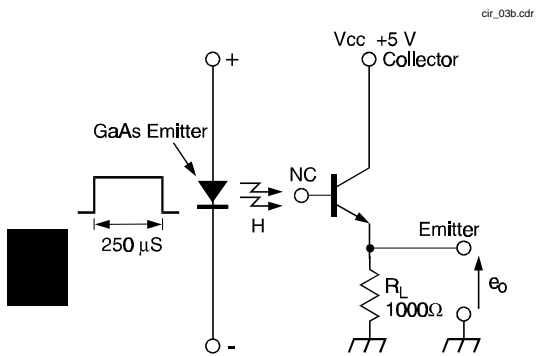
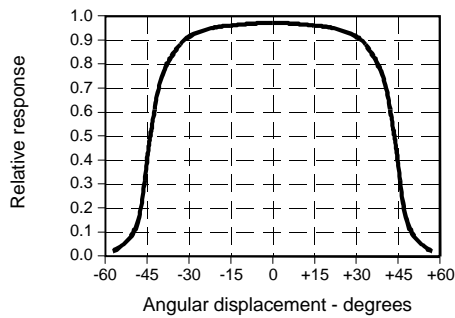

Fig. 1 Responsivity vs Angular Displacement (SD3443) gra_052.ds4



SWITCHING WAVEFORM

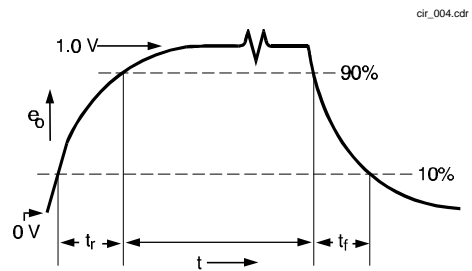

Fig. 2 Responsivity vs Angular Displacement (SD5443) gra_053.ds4

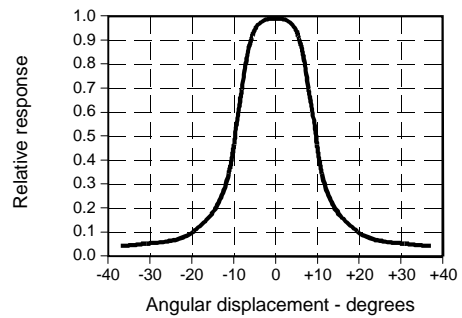

Fig. 3 Dark Current vs Temperature gra_303.cdr

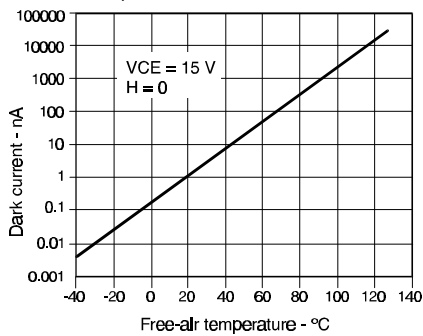
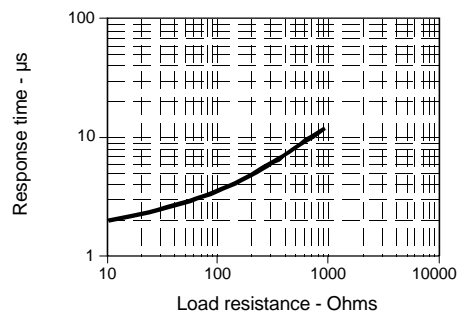

Fig. 4 Non-Saturated Switching Time vs Load Resistance gra_041.ds4



SD3443/5443

Silicon Phototransistor

Fig. 5 Spectral Responsivity

gra_036.ds4

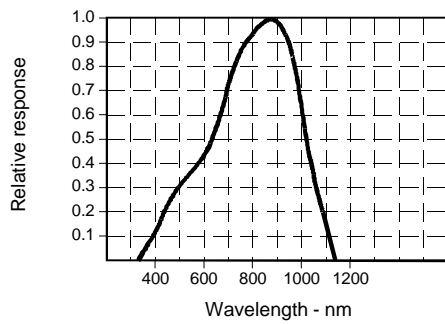

Fig. 6 Coupling Characteristics SE3450 with SD3443

gra_021.ds4

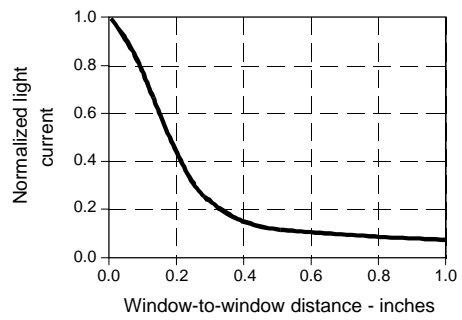

Fig. 7 Coupling Characteristics SE5450 with SD5443

gra_024.ds4

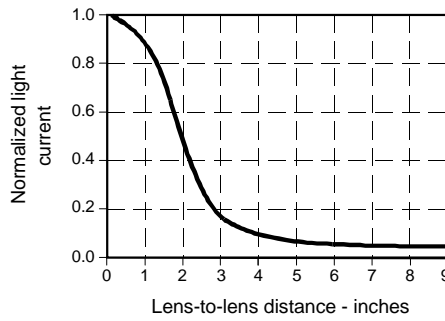
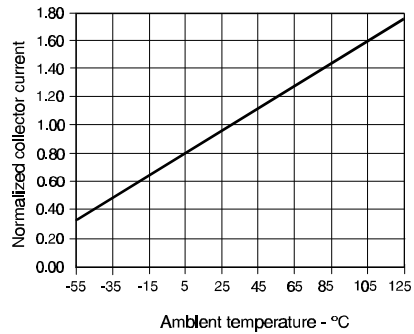

Fig. 8 Collector Current vs Ambient Temperature

gra_302.cdr



All Performance Curves Show Typical Values

Honeywell reserves the right to make changes in order to improve design and supply the best products possible.

Honeywell

X-ON Electronics

Largest Supplier of Electrical and Electronic Components

Click to view similar products for [Phototransistors](#) category:

Click to view products by [Honeywell](#) manufacturer:

Other Similar products are found below :

[LTR-5576D](#) [QSD123A4R0](#) [ASDL-6620-C22](#) [OED-ST-8LR2](#) [OED-STR44B90-TR](#) [SD5410-109](#) [PT91-21C/TR7](#) [PT91-21C/TR10](#)
[LKPT30102B-A01\(XY\)](#) [L-51ROPT1D1](#) [BP 103-3/4](#) [BPY 62](#) [KPS-3227SP1C](#) [L-53P3BT](#) [L-53P3C](#) [L-93DP3BT](#) [L-93DP3C](#) [LL-503PTC2E-1AD](#) [LL-S150PTC-1A](#) [SCM-014TBT86](#) [SFH 309-56](#) [SFH 310 FA](#) [SFH 320](#) [SFH 320-3](#) [SFH 320 FA](#) [SFH 320-Z](#) [SFH 3400-Z](#) [OP508FA](#)
[TEMT1030](#) [LTR-301](#) [PGM5516](#) [PGM5516-MP](#) [PGM5526-MP](#) [PGM5537-MP](#) [PGM5549-MP](#) [PGM5637D](#) [PGM5639D](#) [KPA-3010P3C](#)
[SFH 313 FA-34](#) [VEMT4700F-GS08](#) [PT19-21B/L41/TR8](#) [PT91-21C](#) [KP-2012P3C](#) [TEKT5400S](#) [RPT-37PB3F](#) [RPM-075PTT86](#) [SD1410-128L](#) [SFH 320 FA-4-Z](#) [SFH 309 FA-56](#) [SFH 313 FA-2/3](#)