

Interactive Catalog Supplements Catalog PDFs

If you need detailed product information, or help choosing the right product for your application, see our [Interactive Catalog](#). Use the [Interactive Catalog](#) to access the most complete and up-to-date information available.

The [Interactive Catalog](#) provides an extensive collection of product specifications, application data, and technical literature that can be searched based on criteria you select.

This PDF catalog information was published in November 2000.



Sensing and Control
[Interactive Catalog...](#)

**Click this icon to try
the Interactive Catalog.**

Sensing and Control

Honeywell Inc.

11 West Spring Street

Freeport, IL 61032



O.F. (max.)	1,200 g
R.F. (min.)	500 g
P.T. (max.)	1.5 mm
O.T. (min.)	3 mm
D.T. (max.)	0.1 mm
O.P.	31.4 mm

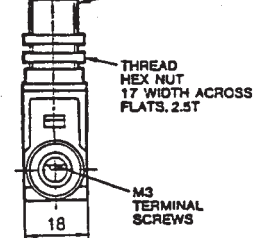
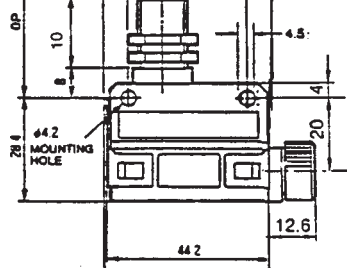

CROSS ROLLER PLUNGER

Catalog Listing	SL1-D
	SL1-DK
O.F. (max.)	1,200 g
R.F. (min.)	500 g
P.T. (max.)	1.5 mm
O.T. (min.)	3 mm
D.T. (max.)	0.1 mm
O.P.	31.4 mm

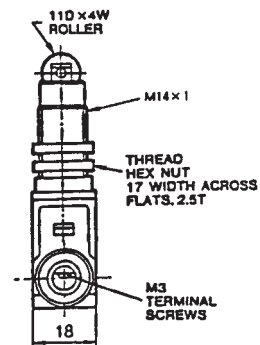
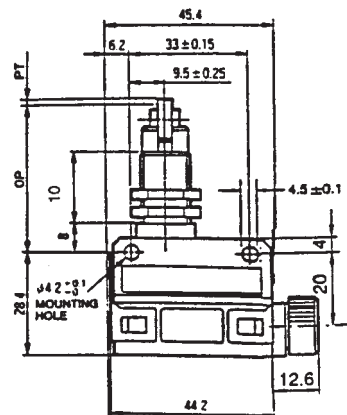

Characteristics: O.F. - Operating Force; R.F. - Release Force; P.T. - Pretravel; O.T. - Overtravel; D.T. - Differential Travel; N - Newtons

ROLLER PLUNGER WITH SEAL BOOT

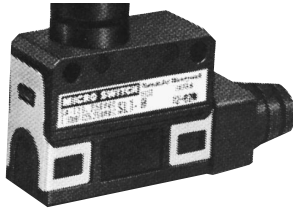

Catalog Listing	SL1-B
	SL1-BK
O.F. (max.)	1,200 g
R.F. (min.)	500 g
P.T. (max.)	1.5 mm
O.T. (min.)	3 mm
D.T. (max.)	0.1 mm
O.P.	41.4 mm

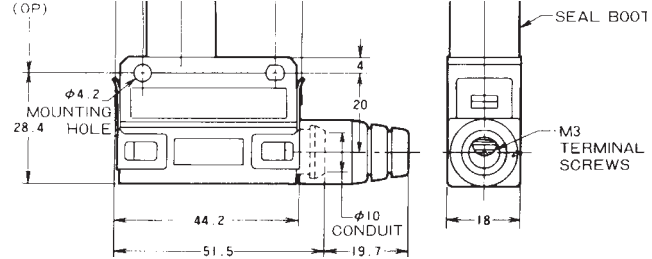

LONG ROLLER PLUNGER

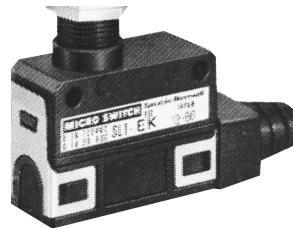

Catalog Listing	SL1-E
	SL1-EK
O.F. (max.)	1,200g
R.F. (min.)	500g
P.T. (max.)	1.5 mm
O.T. (min.)	3 mm
D.T. (max.)	0.1 mm
O.P.	41,4 mm

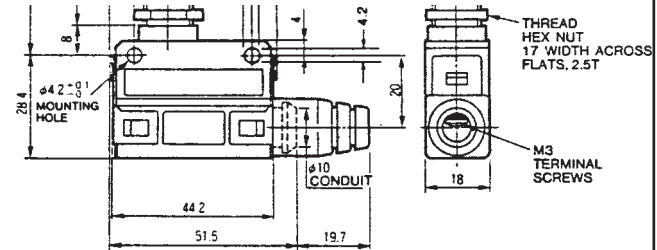

<ul style="list-style-type: none"> ● Neon lamp ● 100 to 250 VAC ● Silver contact 	SL1-□ EXG2	
<ul style="list-style-type: none"> ● LED lamp ● 24 VDC ● Gold clad 	SL1-□ KFXG2	

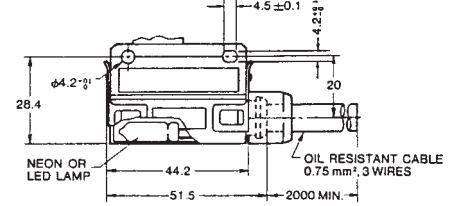

X-ON Electronics

Largest Supplier of Electrical and Electronic Components

Click to view similar products for [Limit Switches](#) category:

Click to view products by [Honeywell](#) manufacturer:

Other Similar products are found below :

[5ML1-E1](#) [5ML31](#) [LZG1](#) [LZL1-6C](#) [622EN114-R](#) [622EN18-6](#) [622EN224-6B](#) [622EN230](#) [622EN237-R](#) [622EN69-3](#) [622EN85-RB](#) [MA-10019](#)
[6PA109](#) [7LS51](#) [83547001](#) [83725002](#) [83830001](#) [83840701](#) [83841001](#) [83881140](#) [8AS42](#) [8LS10](#) [8LS125-4PG](#) [8LS152-4PGN20](#) [914CE16-](#)
[3A](#) [914CE3-3L1](#) [915PA10](#) [91MCE16-P2O](#) [924CE16-Y3](#) [924CE1-S6](#) [924CE1-T25A](#) [924CE1-T3](#) [924CE1-T9A](#) [924CE2-T9](#) [924CE31-Y20-](#)
[X5](#) [924CE31-Y3L1](#) [GL-10054](#) [GLAB26J2B](#) [GLDB03C-6](#) [GLDC05C](#) [GLZ324](#) [PS21R-NT11N7-YK0](#) [H3141CAKAA](#) [RDI-G-L5B](#) [DD-](#)
[10000](#) [DT-2R3-A7](#) [14CE16-3N28](#) [14CE18-N15](#) [151ML3-E1](#) [E3102BAAAA](#)