

SenSym

SLP004D 0 - 4 In. H₂O

LOW PRESSURE SENSORS

FEATURES

- Accurate Low Pressure Readings
- Low Cost
- High Impedance Bridge
- Low Noise
- Low power Consumption for Battery Operation

APPLICATIONS

- Medical Instrumentation
- Portable and Battery Powered Equipment
- Air Flow Monitoring
- HVAC
- Industrial Controls

EQUIVALENT CIRCUIT

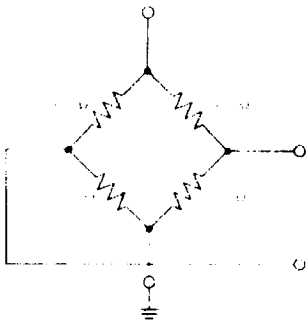

Note: Polarity applies for positive pressure applied to port P2

GENERAL DESCRIPTION

The SLP Series of pressure sensors provides the lowest cost components for measuring very low pressures. These low pressure range devices were specifically designed to accurately measure differential and gage pressures of 0 to 4 inches of H₂O. They are meant for use with non-corrosive and non-ionic media, such as air, dry gases and the like.

These differential devices allow application of pressure to either side of the diaphragm and can be used for gage or differential pressure measurements.

For further technical information on the SLP Series, please contact the factory.

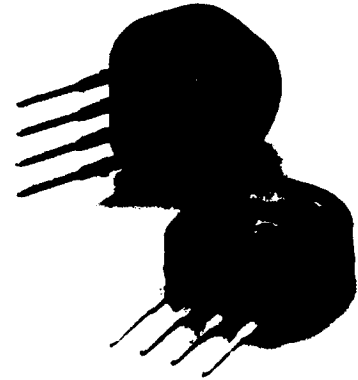

ELECTRICAL CONNECTION

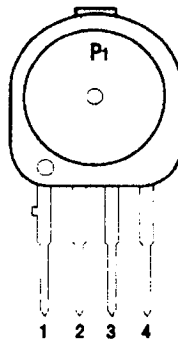

1) +V_S 2) + OUTPUT
3) GROUND 4) - OUTPUT

BUTTON PACKAGE

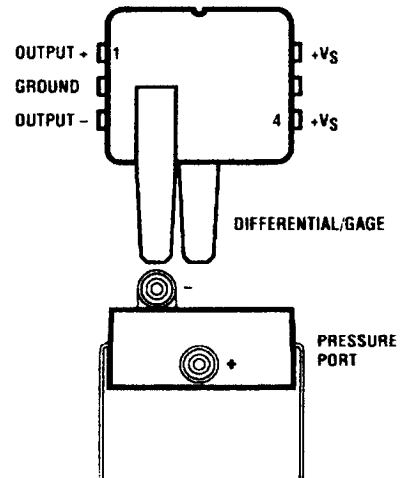

"D4" DIP PACKAGE

ABSOLUTE MAXIMUM RATINGS (For All Devices)

Supply Voltage (V)	7.5V _{DC}
Temperature Range	
Operating	0 to 50°C
Storage	0 to 70°C
Common-mode Pressure	150 In. H ₂ O
Lead Temperature	
(Soldering 2-4 seconds)	250°C
Proof Pressure	10 In. H ₂ O
Burst Pressure ⁽⁹⁾	5 psi

SLP004D PERFORMANCE CHARACTERISTICS ⁽¹⁾

Characteristic	Min.	Typ.	Max.	Unit
Operating Pressure	—	—	4	In. H ₂ O
Sensitivity T _A =25°C	+1700	+2500	+5500	μV/V/In. H ₂ O
Full-scale Span 4 In. H ₂ O ⁽²⁾	+34	+50	+110	mV
Temperature Coefficient of Span ^(5, 8)	-2850	-2400	-1950	ppm/°C
Zero Pressure Offset T _A =25°C	-40	0	+40	mV
Temperature Coefficient of Offset ⁽⁵⁾	—	±4	—	μV/V/°C
Combined Linearity and Hysteresis ⁽³⁾	—	0.5	1.0	%FS
Long Term Stability of Offset and Sensitivity ⁽⁷⁾	—	0.5	—	%FS
Response Time (10% to 90%) ⁽⁶⁾	—	100	—	μs
Input Resistance T _A =25°C	—	4.7	—	kΩ
Temperature Coefficient of Resistance ^(5, 8)	+2100	+2300	+2500	ppm/°C
Output Impedance	—	4.70	—	kΩ
Repeatability ⁽⁴⁾	—	0.5	—	%FS
Position Sensitivity	—	50	—	μV/V/g

SPECIFICATION NOTES: (FOR ALL DEVICES)

- Note 1: Reference Conditions: Supply Voltage, V_S=5V_{DC}, T_A=25°C, Common-mode Line Pressure=0 psig, Pressure Applied to P2.
- Note 2: Span is the algebraic difference between the output voltage at full-scale pressure and the output at zero pressure.
- Note 3: See Definition of Terms.
Hysteresis—the maximum output difference at any point within the operating pressure range for increasing and decreasing pressure.
- Note 4: Maximum difference in output at any pressure with the operating pressure range and temperature within 0°C to +50°C after:
a) 1,000 temperature cycles, 0°C to 50°C
b) 1.5 million pressure cycles, 0 psi to full-scale span.
- Note 5: Slope of the best straight line from 0°C to 50°C. For operation outside this temperature, contact factory for more specific applications information.
- Note 6: Response time for a 0 psi to full-scale span pressure step change. 10% to 90% Rise Time
- Note 7: Long term stability over a one year period.
- Note 8: This parameter is not 100% tested. It is guaranteed by process design and tested on a sample basis only.
- Note 9: If the maximum burst pressure is exceeded, even momentarily, the package may leak or burst, or the pressure sensing die may fracture.

WARNING:

Due to the delicate nature of these very sensitive devices, some special handling is required. Parts are sensitive to shock and vibration and must be handled with care. Dropping on any hard surface (bench top

TYPICAL PERFORMANCE CHARACTERISTICS

**Sensitivity vs Temperature
(Constant Voltage)**

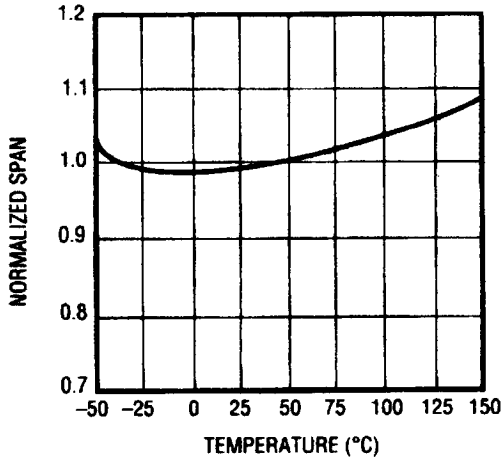

Nonlinearity vs Pressure

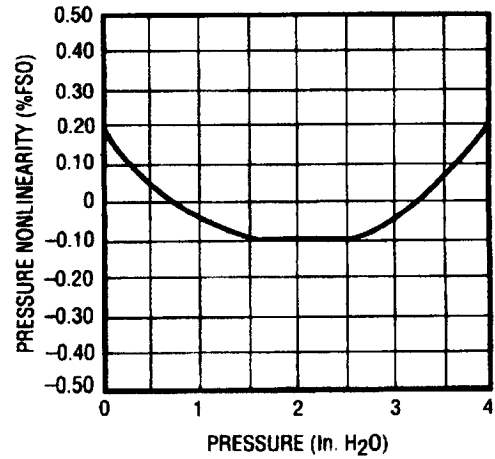

0.1 Hz to 10 Hz Noise

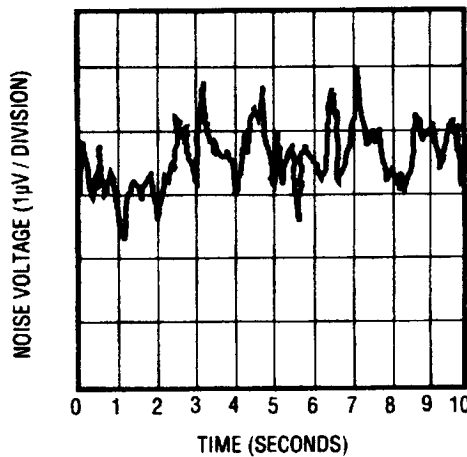

APPLICATION INFORMATION

GENERAL INFORMATION

The SLP family of pressure sensors function as a wheatstone bridge. When pressure is applied to the device the resistors in the arms of the bridge change as shown in Figure 1.

The resulting differential output voltage, V_0 , is easily shown to be $V_0 = V_B \times \Delta R/R$. Since the change in resistance is directly proportional to pressure, V_0 can be written as:

where: V_0 is the output voltage in mV

S is the sensitivity in mV/V psi

P is the pressure in psi

V_B is the bridge voltage in volts

V_{OS} is the offset error, (the differential output voltage when the applied pressure is zero).

For a complete application discussion, see SenSym's SCC Series Datasheet.

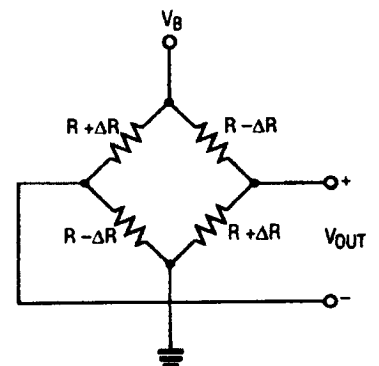

ORDERING INFORMATION

To order, use the following part numbers:

Pressure Range	Sensor In Button Package	Sensor In DIP Package
0 to 4 In. H ₂ O	SLP004D	SLP004DD4

See Section 10 for Package Styles and Dimensions

X-ON Electronics

Largest Supplier of Electrical and Electronic Components

Click to view similar products for [Board Mount Pressure Sensors](#) category:

Click to view products by [Honeywell](#) manufacturer:

Other Similar products are found below :

[6407-249V-17343P](#) [6407-250V-09273P](#) [80527-25.0H2-05](#) [80541-B00000150-01](#) [80541-B00000200-05](#) [80554-00700100-05](#) [80568-00300050-01](#) [93.631.4253.0](#) [93.731.4353.0](#) [93.932.4553.0](#) [136PC150G2](#) [136PC15A1](#) [142PC95AW71](#) [142PC05DW70](#) [15PSI-G-4V](#) [1805-01A-L0N-B](#) [26PCBKT](#) [26PCCFA6D26](#) [26PCCFS2G](#) [26PCCVA6D](#) [93.632.7353.0](#) [93.731.3653.0](#) [93.931.4853.0](#) [93.932.4853.0](#) [SCDA120-XSC05DC](#) [185PC30DH](#) [20INCH-G-MV-MINI](#) [26PCAFJ3G](#) [26PCCEP5G24](#) [26PCDFA3G](#) [26PCJEU5G19](#) [ASCX15AN-90](#) [TSCSAAN001PDUCV](#) [DCAL401DN](#) [DCAL401GN](#) [XZ202798SSC](#) [XZ203676HSC](#) [6407-249V-09343P](#) [6407-250V-17343P](#) [SP370-25-116-0](#) [81794-B00001200-01](#) [HSCDLNN100PGAA5](#) [82681-B00000100-01](#) [81618-B00000040-05](#) [SSCDJNN015PAAA5](#) [TSCDLNN100MDUCV](#) [TSCSAAN100PDUCV](#) [NBPDANN015PGUNV](#) [NBPLLNS150PGUNV](#) [142PC100D](#)